

**fischertechnik** 

**PROFI**

Bedienungsanleitung  
Instruction Manual  
Mode d'emploi  
Gebruiksaanwijzing  
Manual de instrucciones  
Instruções de operação  
Manuale di istruzioni  
Инструкция по эксплуатации  
操作说明书

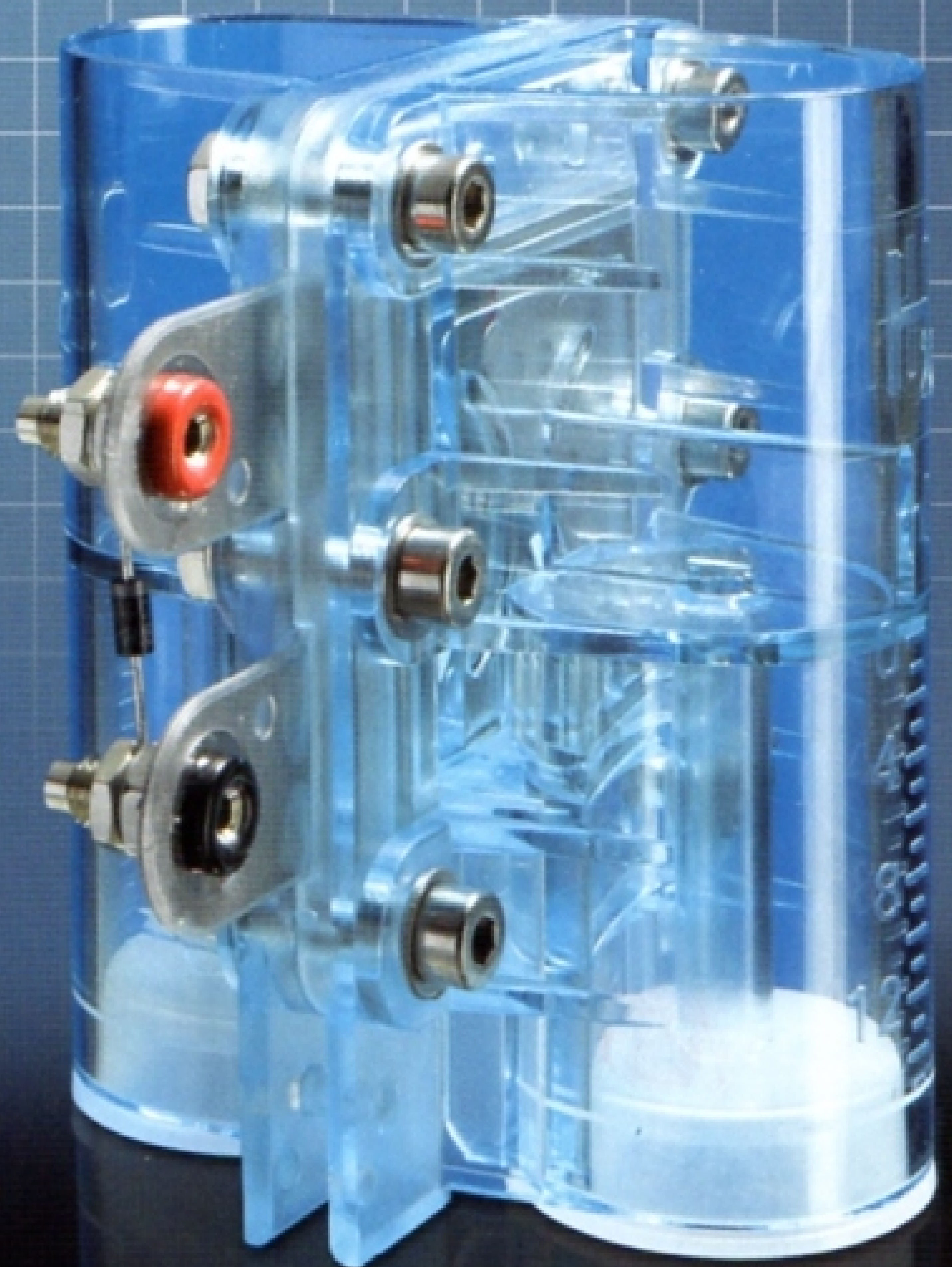
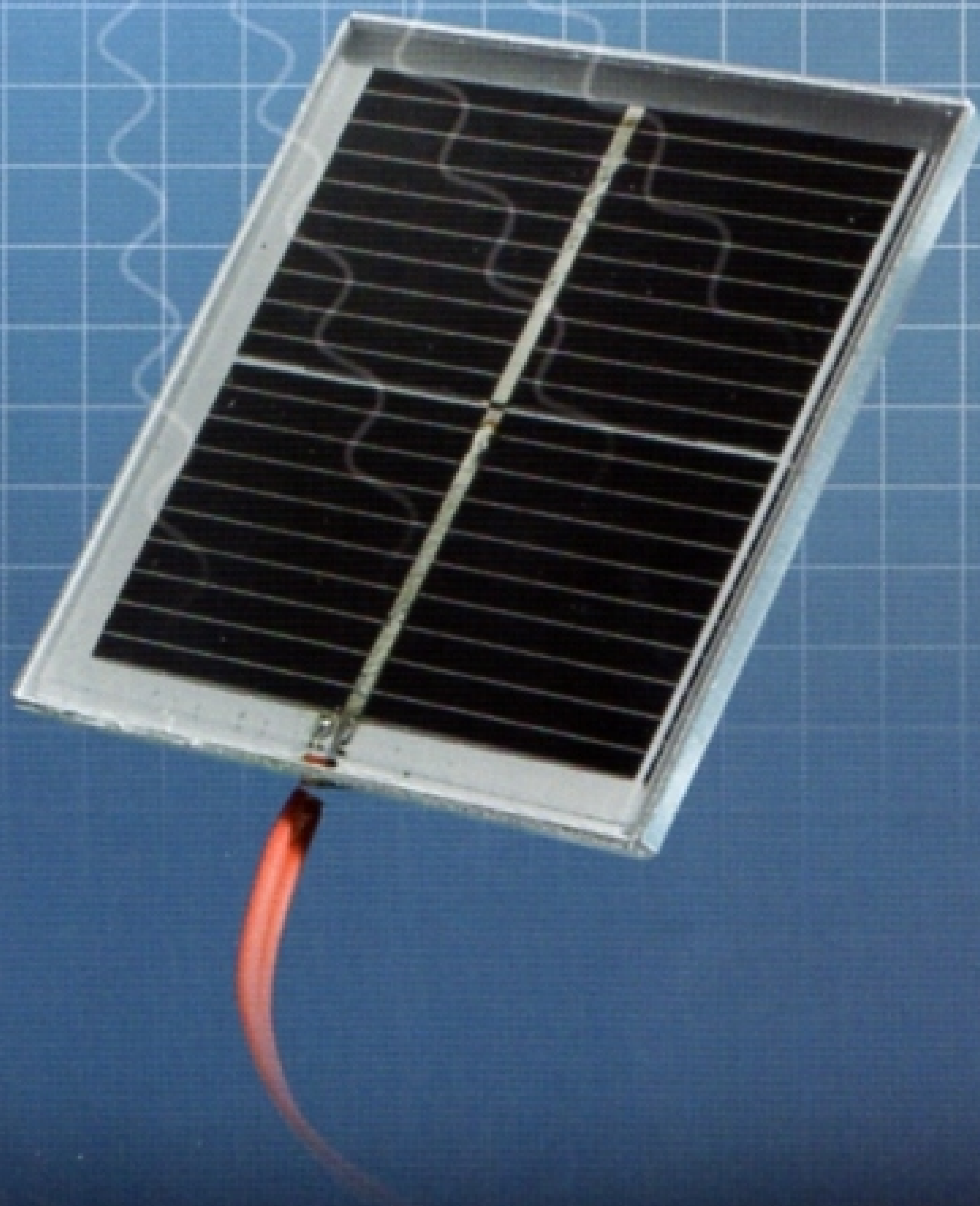

**Hydro Cell Kit**

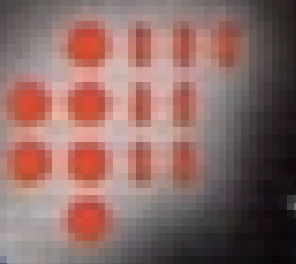
Hydro Cell by  
**Heliocentris** 

**D** Seite 5–14

## **Bedienungsanleitung für das Hydro Cell Kit**

Beschreibt die Brennstoffzelle und enthält verschiedene Experimente.

**GB+USA** Page 15–24

## **Instruction Manual for the Hydro Cell Kit**

Describes the fuel cell and contains a range of different experiments.

**F** Page 25–34

## **Mode d'emploi du Hydro Cell Kit**

Décrit la cellule électrochimique et contient différents essais.

**NL** Pagina 35–44

## **Gebbruiksaanwijzing voor de Hydro Cell Kit**

Beschrijft de brandstofcel en bevat verschillende experimenten.

**E** Página 45–54

## **Manual de instrucciones para el Hydro Cell Kit**

Describe la célula de combustible y contiene diversos experimentos.

**P** Página 55–64

## **Instruções de operação para o Hydro Cell Kit**

Descreve a célula a combustível e contém diversos experimentos.

**I** Pag. 65–74

## **Manuale di istruzioni del Hydro Cell Kit**

Descrive la cella di carburante e contiene diversi esperimenti.

**RU** Страница 75–84

## **Инструкция по эксплуатации Hydro Cell Kit**

Содержит описание топливного элемента и различных экспериментов.

**CN** 第 85–94 页

## **Hydro Cell Kit 操作说明书**

介绍说明燃料电池及其各种不同的实验。

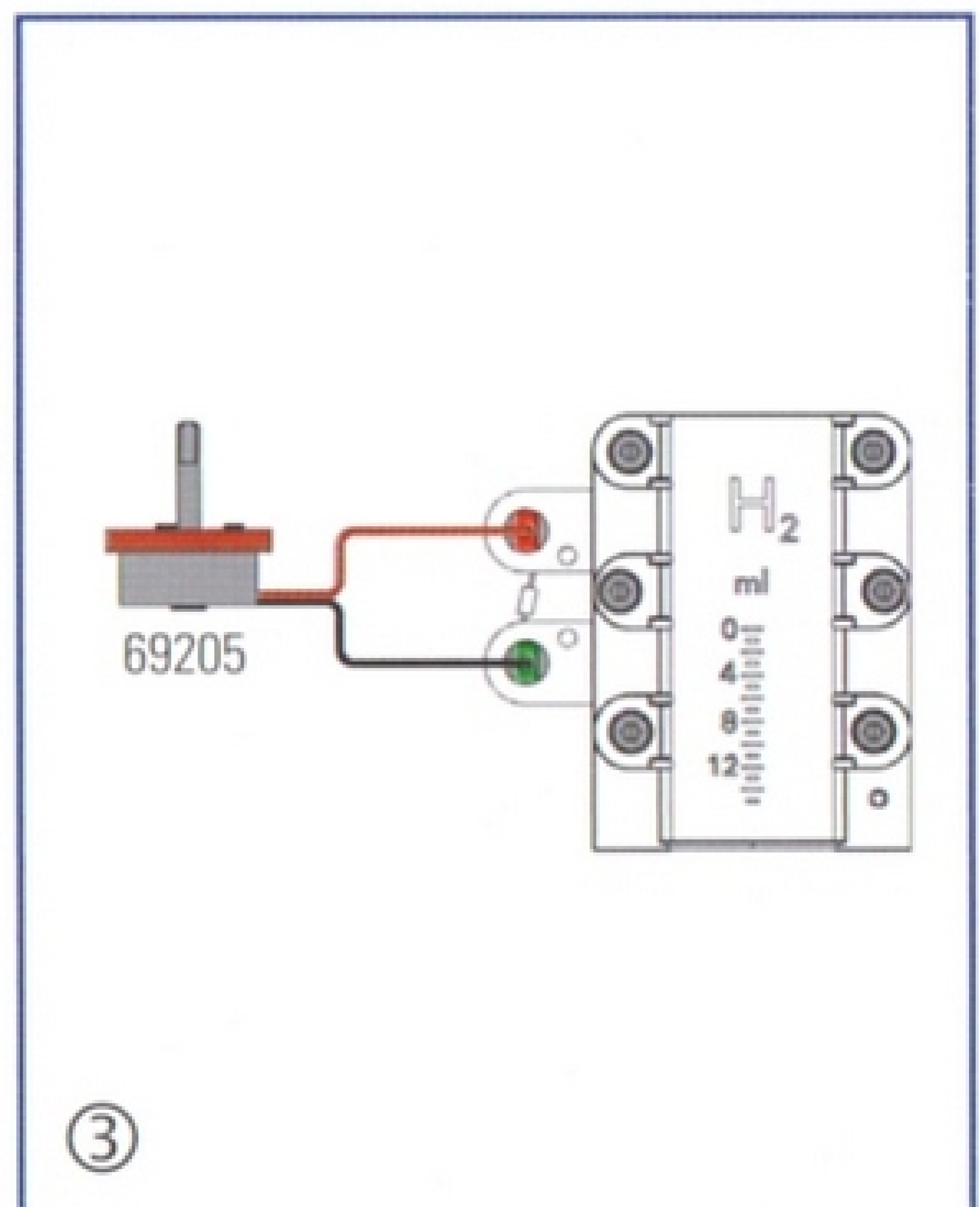
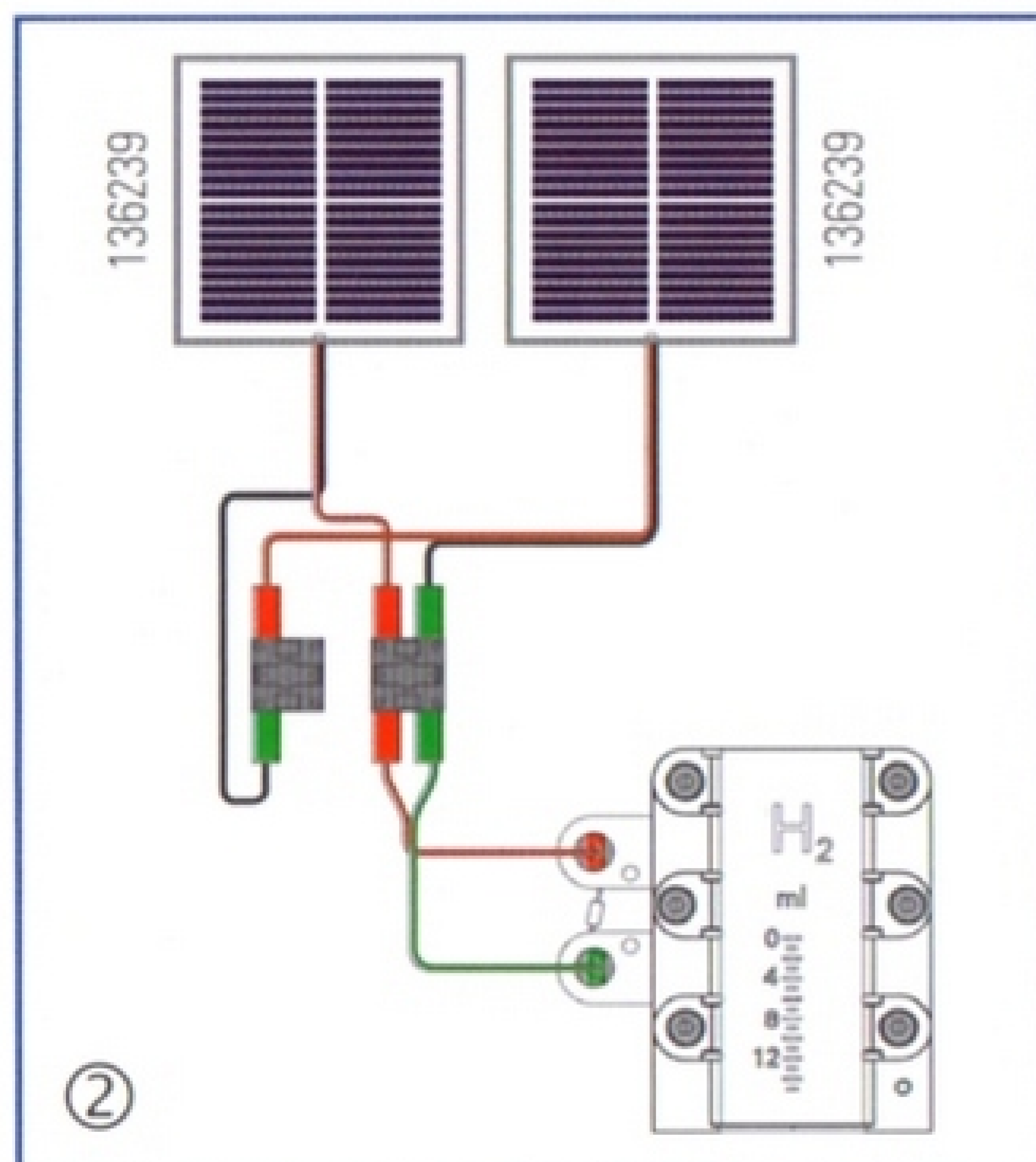
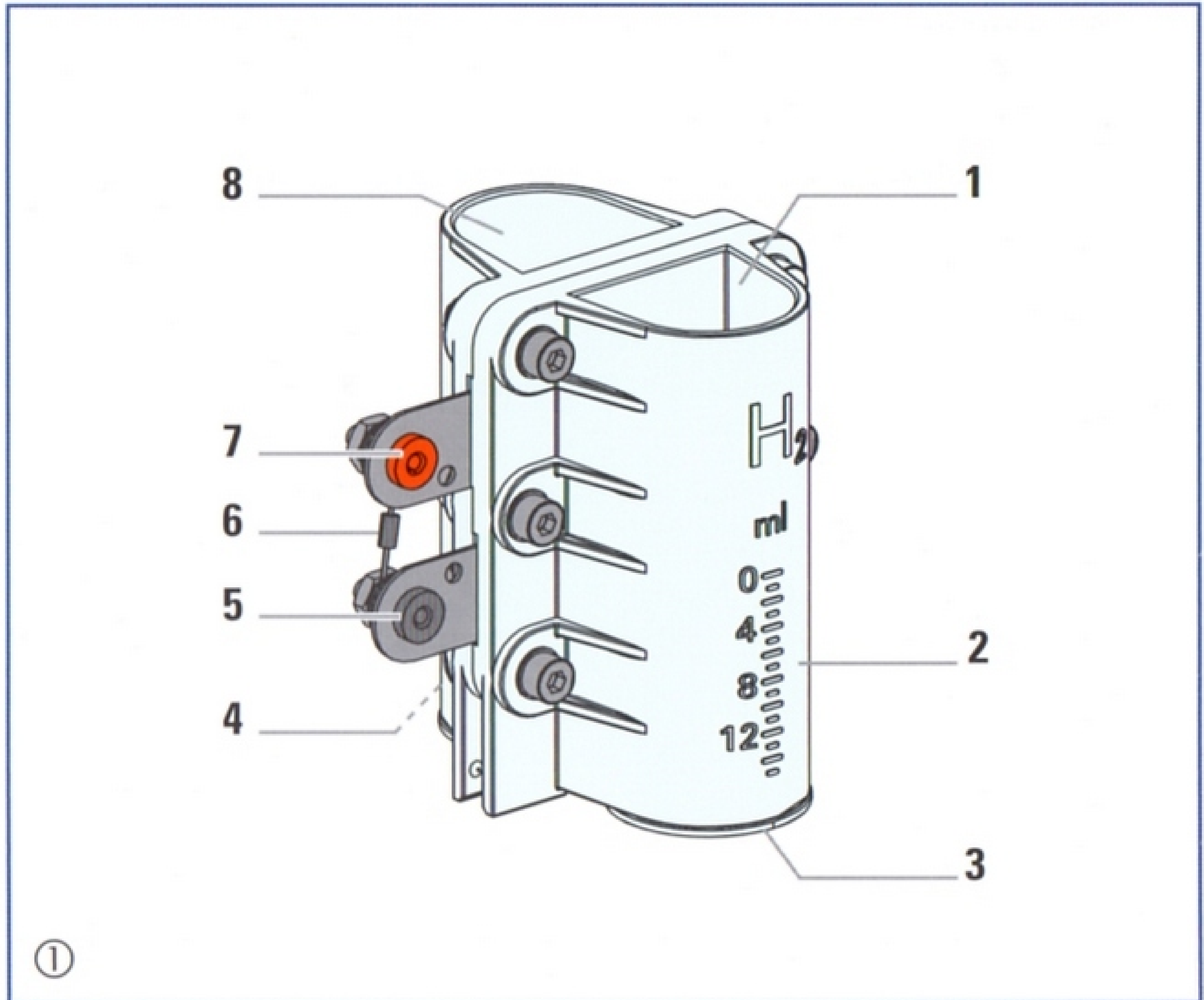

# PROFI HYDRO CELL KIT

Einzelteilübersicht

Spare parts list

Liste des pièces détachées

Onderdelenoverzicht









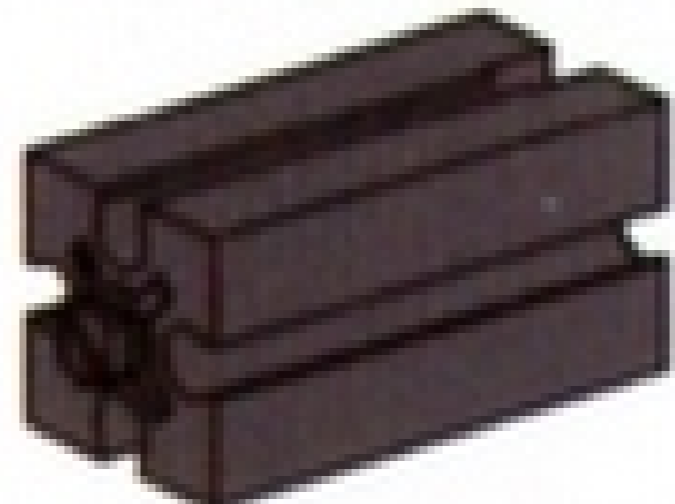

Lista da piezas

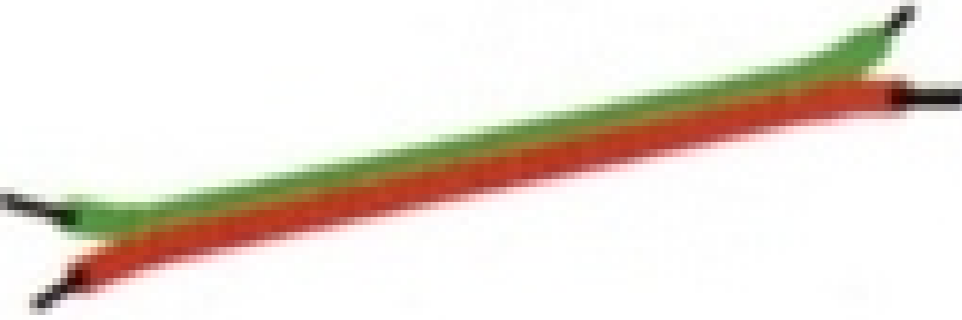
Resumo de peça individual

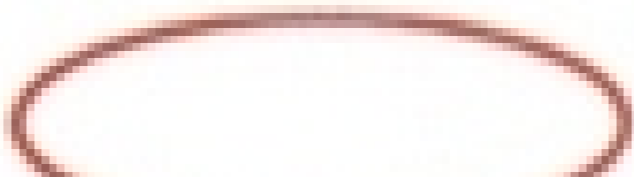
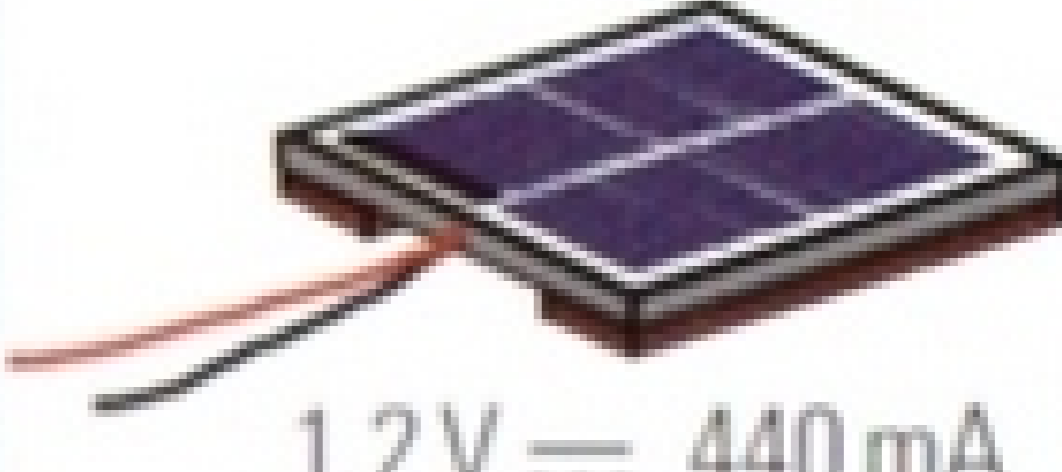
Singoli componenti

Отдельные детали

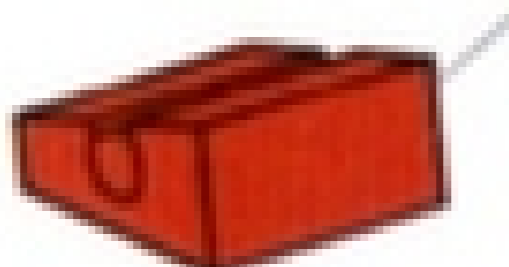
零件概览

	31 031 1 x		32 879 1 x		38 216 1 x
	31 336 3 x		36 977 1 x		38 464 2 x
	31 337 3 x		36 981 1 x	 1,2 V ---, 440 mA	136 239 1 x
	31 597 3 x		37 034 2 x		136 734 1 x
 15°	31 981 4 x		37 237 1 x		136 770 2 x

Montagetipps

Tips for assembly

Tuyaux pour le montage

Montagetips

Consejos para el montaje

"Dicas" para montagem

Consigli per il montaggio

Советы и рекомендации по сборке

装配建议

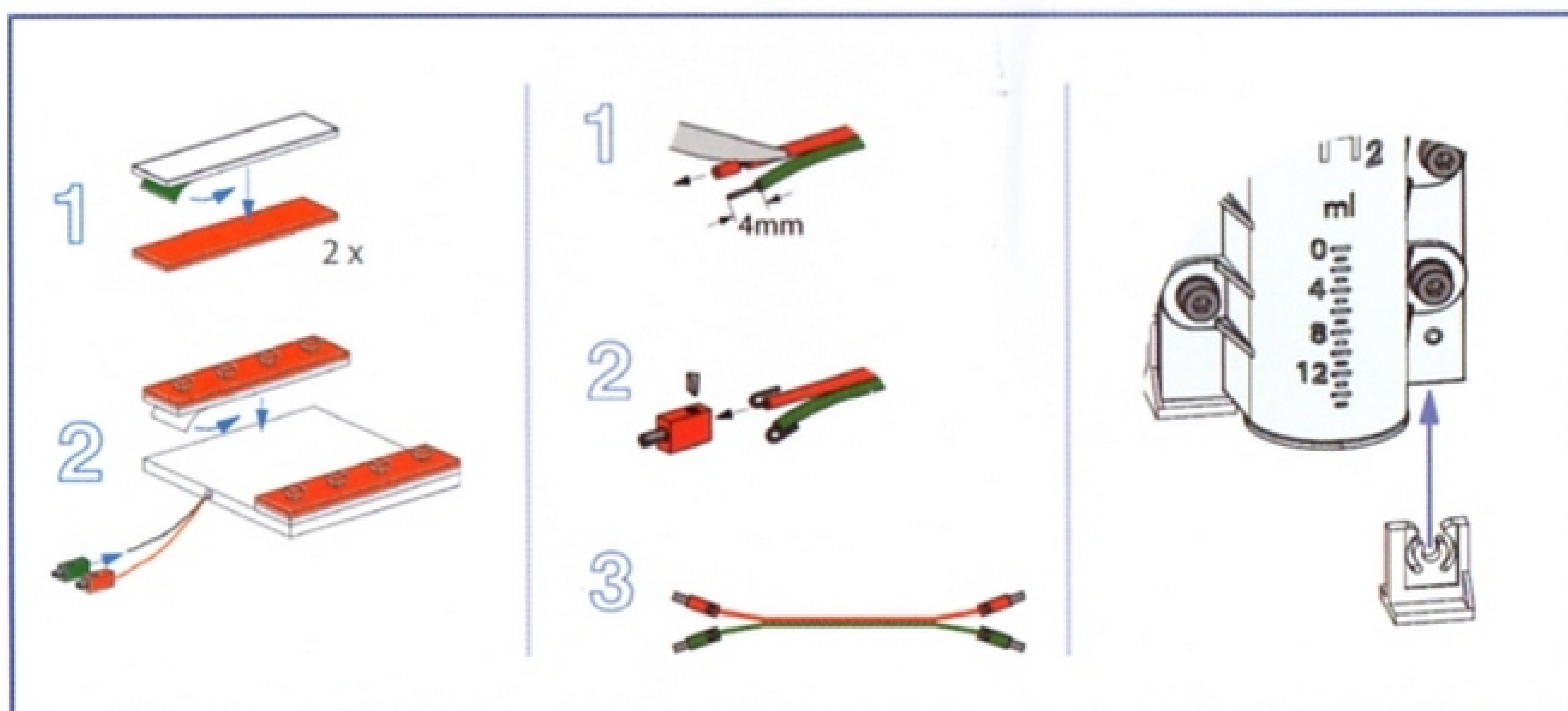

## CONTENTS

<b>Hydro Cell Kit.....</b>	<b>p. 16</b>
Important Instructions on Use of the Hydro Cell Kit .....	p. 16
<b>Safety Instructions .....</b>	<b>p. 16</b>
Proper Use .....	p. 16
<b>How the Fuel Cell Works .....</b>	<b>p. 17</b>
<b>Operation of the Fuel Cell .....</b>	<b>p. 18</b>
Filling the fuel cell with distilled water .....	p. 18
Producing hydrogen and oxygen (electrolysis) .....	p. 19
Producing electrical energy .....	p. 21
Shutting down/storing the fuel cell .....	p. 21
<b>Information about Environmental Protection .....</b>	<b>p. 21</b>
<b>Liability.....</b>	<b>p. 21</b>
<b>Experiments using the Hydro Cell Kit + Profi Oeco Tech .....</b>	<b>p. 22</b>
<b>Experiments using the Hydro Cell Kit + Profi Oeco Power.....</b>	<b>p. 22</b>
<b>Fuel Cell Technical Data .....</b>	<b>p. 24</b>
<b>Troubleshooting .....</b>	<b>p. 24</b>
<b>Circuit Diagrams for the Hydro Cell Kit + Profi Oeco Power.....</b>	<b>p. 101</b>

## Hydro Cell Kit

How does a fuel cell work? How can you produce hydrogen with it? The Hydro Cell Kit provides knowledge for all areas associated with this exciting topic. With the fuel cell and the additional solar module, interesting additional models can be built in connection with the construction set, Profi Oeco Tech. The instructional activity booklet in the Profi Oeco Tech kit offers assistance. All of your questions are answered.

### Important instructions on use of the Hydro Cell Kit

The Hydro Cell Kit is an extension kit. You will also need the Profi Oeco Tech kit (Item # 505284) to operate the fuel cell and to perform the experiments in this instruction manual. Alternatively, you can also use the Profi Oeco Power kit (Item # 57485).

## Safety Instructions

- The fuel cell may only be operated with a direct voltage up to 2 V. Never connect other, e.g. 9 V fischertechnik power supplies.
- Do not short circuit the contact points of the fuel cell.
- Too high voltage or a short circuit can destroy the fuel cell membrane.
- Do not use the fuel cell for:  
The production of electricity and hydrogen for any purposes other than those given in the instruction manual.  
The production and/or storage of more hydrogen than fits in the storage cylinder of the fuel cell (around 15ml).  
Continuous electrolysis.
- The fuel cell produces hydrogen. Hydrogen is an extremely flammable gas. No naked flames near the components!

### Proper Use

The Hydro Cell Kit's fuel cell may only be used to operate fischertechnik models.

## How the Fuel Cell Works

■ A fuel cell converts the chemical energy of a fuel (e.g. hydrogen) into electric current (electricity). A fuel cell is therefore not an energy store but an energy converter.

Fuels cells are used, for example, to drive vehicles and to supply homes with heat and electricity.

A fuel cell consists of two electrodes (anode and cathode), which are separated from each other by an electrolyte membrane.

The electrodes are made from metal or carbon. They are coated with a catalyst, for example, platinum or palladium.

Inside the fuel cell, hydrogen and oxygen react to form water. This reaction produces an electric voltage between the two electrodes which can be used, for example, to drive an electric motor.

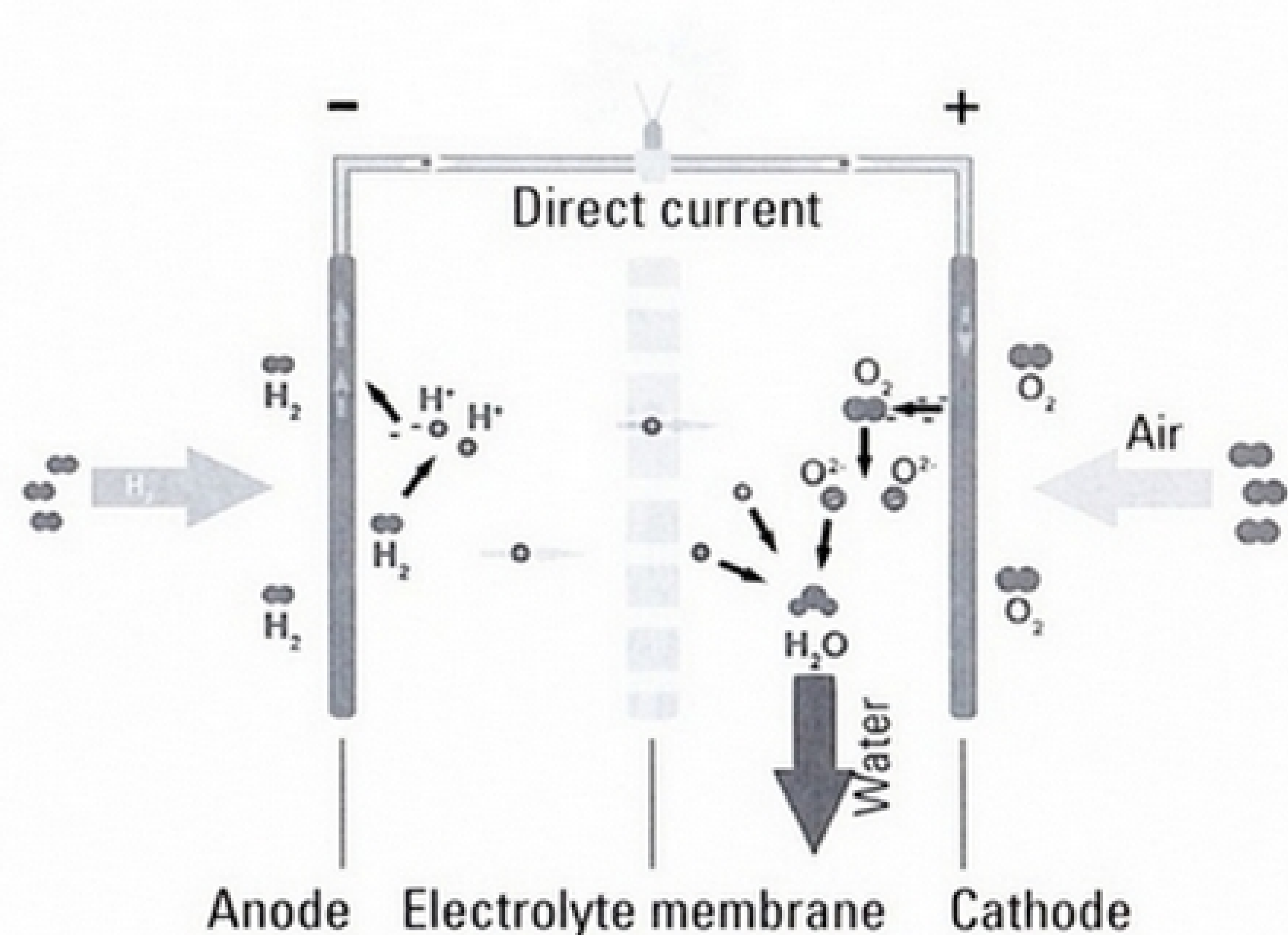

■ The fuel cell included in the Hydro Cell Kit is a so-called reversible fuel cell. This means that the fuel cell has the following two functions:

- On the one hand, the reversible fuel cell can be used as a so-called electrolyzer, for producing hydrogen and oxygen from distilled water. This process is called electrolysis. The hydrogen and oxygen are stored in storage cylinders.
- On the other hand, the reversible fuel cell can be used to produce electrical energy by reacting the stored hydrogen with the stored oxygen.

## Operating the fuel cell

Description of the fuel cell (see Fig. 1 on page 3).

- 1 Overflow chamber, hydrogen side
- 2 Hydrogen storage cylinder
- 3 Plug, hydrogen side
- 4 Oxygen storage cylinder  
(not shown in the diagram)
- 5 Negative jack (black)
- 6 Protective diode
- 7 Positive jack (red)
- 8 Overflow chamber, oxygen side

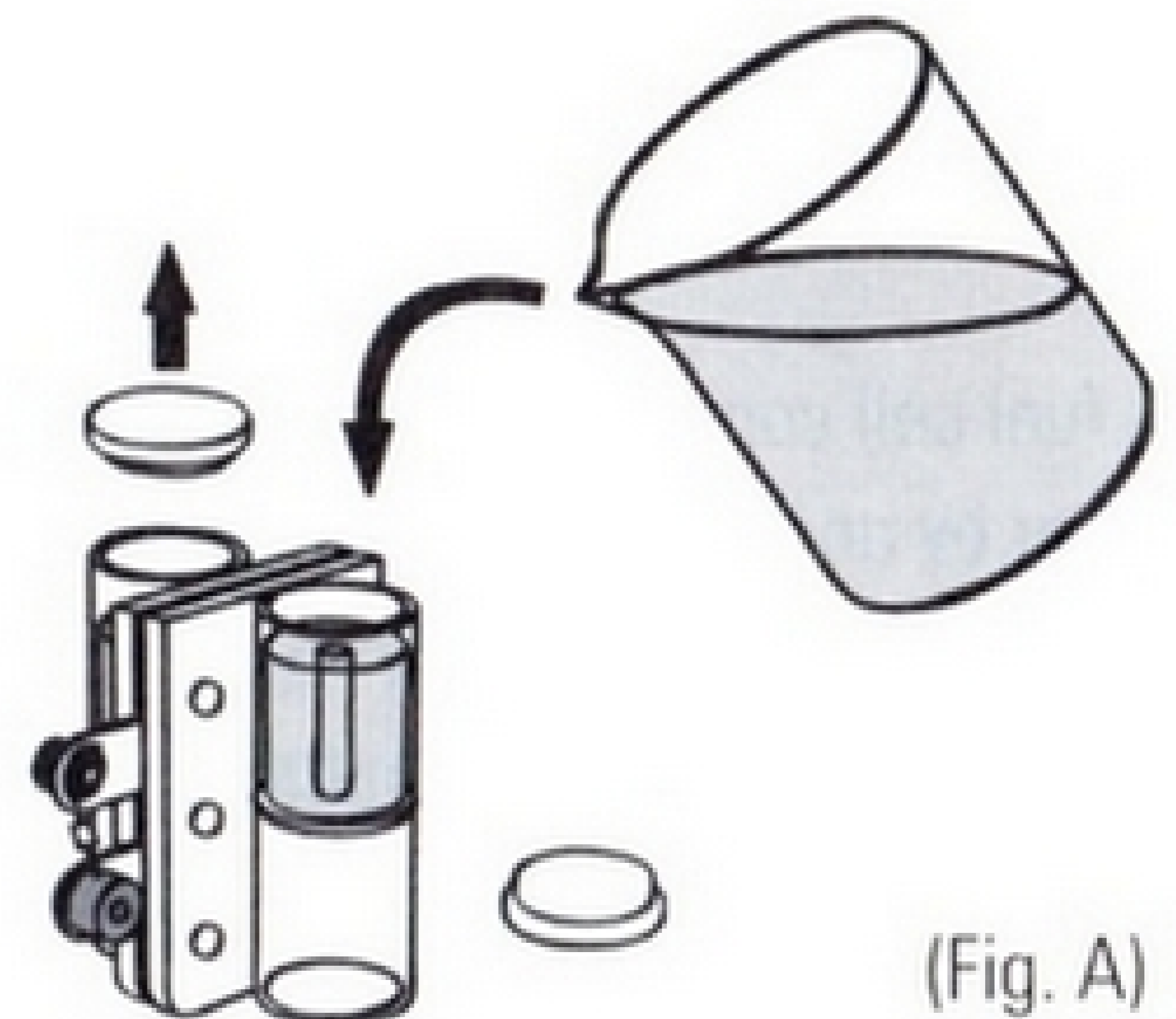

(Fig. A)

### Filling the fuel cell with distilled water

Place the fuel cell on a flat plate with the plugs facing upwards.

Then remove the two plugs. Fill the two storage cylinders with distilled water, up to the top edge of the small tubes (these are positioned inside the cylinders).

(See Fig. A)



#### **Caution! Material damage possible:**

Tap water and other liquids permanently damage the fuel cell membrane.

Gently bang the fuel cell on the table to let the water flow more easily around the membrane and the current collecting metal plates.

Now add a bit more water, just enough for it to run through the small tubes. You can now use the plugs to close the storage cylinders again. Ensure that no air is trapped in the storage cylinder. A small air bubble does not cause any problems and can be ignored.

If the fuel cell has not been used for a long time, wait for around 10 minutes, to allow the membrane to become sufficiently impregnated. Now turn the fuel cell around again.



## Producing hydrogen and oxygen (electrolysis)

The fuel cell must be supplied with a direct voltage between 1.4 and 2 volt.



### Caution! Material damage possible:

If the voltage is too high, it can destroy the fuel cell membrane. The fuel cell must never be connected to a 9 V fischertechnik power supply.

The solar module included in the Hydro Cell Kit consists of two solar cells, which are connected in series. If it is not connected to a load, the solar module supplies a maximum voltage of 1.2 V (no-load voltage). As this voltage is not enough for the electrolysis, you will need another solar module from the Profi Oeco Tech kit.

Connect the two solar modules (Item # 136239) in series and connect them to the fuel cell (see Fig. 2 on page 3). Depending on the light intensity, the two solar modules now supply a voltage of 1.4 – 1.8 volt.

**Tip:** Have you got the "Profi Oeco Power" kit? Then you can use its solar cells and the solar module of the Hydro Cell Kit. Connect them in series and connect everything to the fuel cell (1 x solar module Item # 136239, 2 x solar cells Item # 62567. See Fig. 4 on page 101). The voltage now also reaches 1.4 – 1.8 volt.

Production of hydrogen and oxygen begins as soon as the solar modules or the solar cells are lit with sufficient sunlight or a suitable light source. The gases are stored in the corresponding storage cylinders. The water is pressed into the overflow chambers above the cylinders.

The fuel cell is completely "charged" when all the water from the hydrogen storage cylinder (2) has been pressed into the overflow chamber above it (1). This process lasts around 15 – 60 minutes, depending on the light intensity.

You can now disconnect the fuel cell from the solar modules. This stops the production of hydrogen and oxygen.

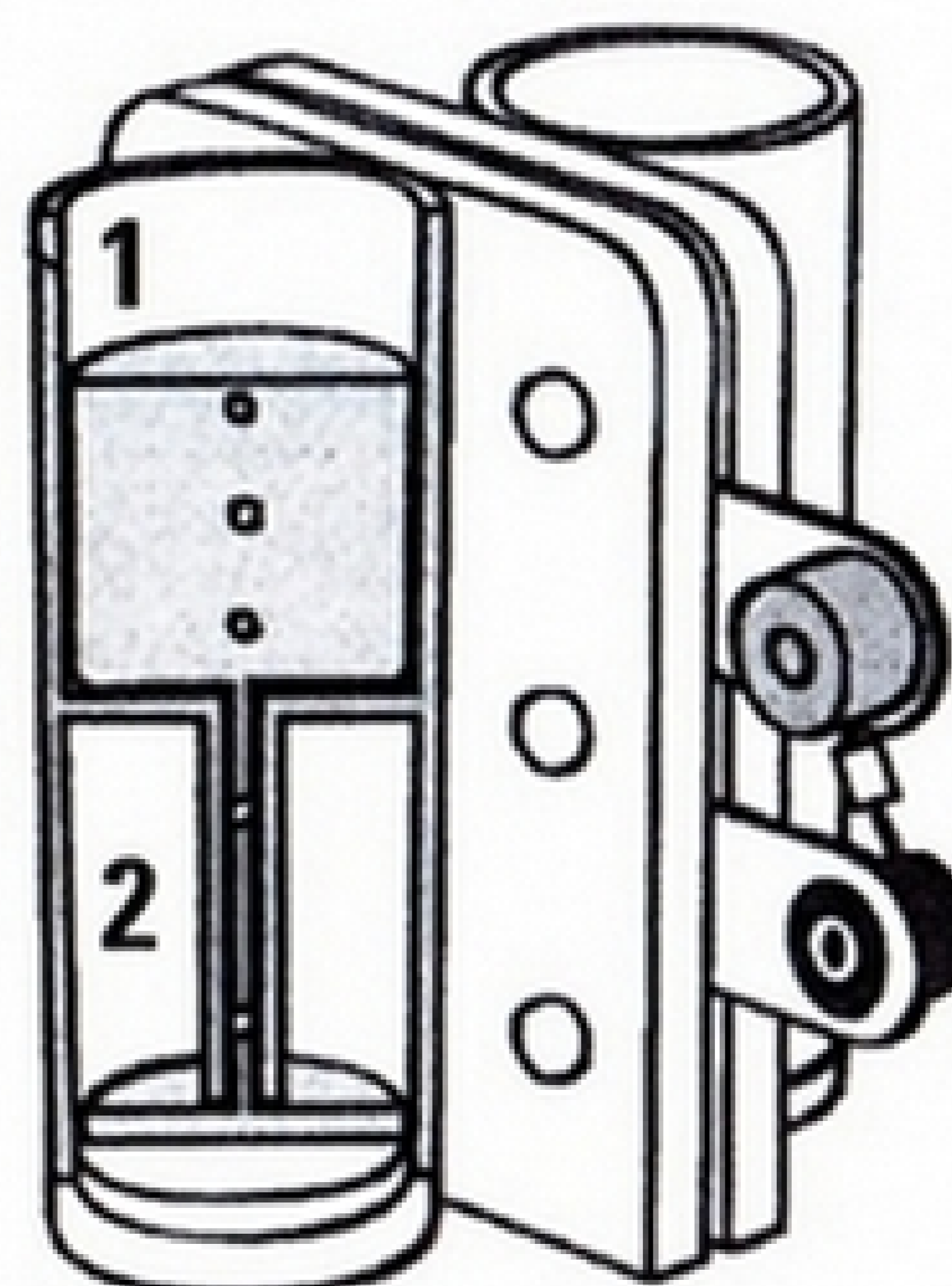

**Tip:** If you want to achieve the optimum output of the fuel cell, flush all the air out of the fuel cell. To do this, continue producing hydrogen until the last of the water has been pressed out of the oxygen storage cylinder and into the overflow chamber above it.

### Experiment 1:

Measure how much hydrogen is produced in a certain period of time during the production of hydrogen and oxygen. You can read off the quantity of hydrogen from the scale on the hydrogen storage cylinder. Watch what effect the light intensity has on the quantity produced.

If the light intensity is high, more hydrogen is produced during the same time. If the light intensity is too low, no hydrogen is produced at all.

If you use a 100 W light bulb as a light source at a distance of 30 cm from the solar modules, it takes around 15 min for the hydrogen storage cylinder to completely fill with gas.

### Experiment 2:

Observe the quantities of gas in the two storage cylinders during the hydrogen and oxygen production. What can you observe?

Twice as much hydrogen is produced as oxygen. Why?

Water ( $H_2O$ ) consists of compounds of hydrogen ( $H_2$ ) and water ( $O_2$ ). These compounds are called water molecules. A water molecule consists of two hydrogen atoms and one oxygen atom. When the molecule is split during electrolysis, twice as many hydrogen molecules are produced as oxygen molecules.

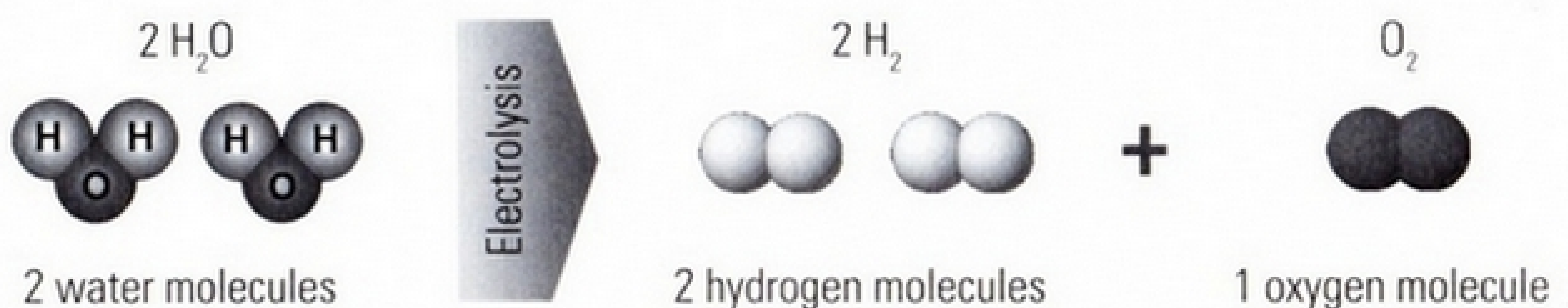

## Producing electric energy

As soon as there is hydrogen and oxygen in the storage cylinders, they react with each other and an electric voltage of 0.5 to 0.9 V is produced at the jacks. The fuel cell supplies a 500 mA current and has a nominal power of 250 mW.

### Experiment:

Connect the motor in the Profi Oeco Tech kit (alternatively: Profi Oeco Power) (Item # 69205) to the jacks of the fuel cell (see Fig. 3, on page 3).

What do you see?

The motor is rotating. It is driven by the electrical energy generated by the fuel cell.

## Shutting down/storing the fuel cell

The fuel cell should not be stored filled with water.

Therefore, after you have finished your experiments, remove the plugs from the fuel cell, pour out the water and leave the fuel cell to dry.

## Information about Environmental Protection

Do not put the electrical and electronic components of this kit (e.g. motors, lamps, sensors) in the household waste. At the end of their service life, turn them in at a collection point for the recycling of electrical and electronic devices.

The symbol on the product, packaging or the instructions shows this.

## Liability

Liability on the part of fischertechnik GmbH for damages, which resulted from the fact that the kit was not used in accordance with instructions, is excluded.

## Experiments using the Hydro Cell Kit + Profi Oeco Tech

The activity booklet supplied with the Profi Oeco Tech kit contains many other exciting experiments, which you can perform using the Hydro Cell Kit.

The corresponding models are described in the Profi Oeco Tech assembly instruction.

## Experiments using the Hydro Cell Kit + Profi Oeco Power

You can also use the Profi Oeco Power kit together with the Hydro Cell Kit to perform other experiments.

For the first experiment, build the rotating swing model (Profi Oeco Power – assembly instruction, p.16). However, you do not have to install the solar cells.

### Experiment 1:

Fill the fuel cell with distilled water, produce hydrogen and oxygen and then connect the motor to the jacks of the fuel cell. The model is now driven by the fuel cell.

Observe how much hydrogen is consumed in how much time while the model is running. You can read off the consumption from the scale on the hydrogen storage cylinder. Calculate how long the model will run with a tank full of hydrogen.

Build the oil pump model for the other experiments (Profi Oeco Power assembly instruction, p.12). However, you do not have to install the solar cells. Instead, connect the motor and the fuel cell to the two solar cells and the solar module, as shown in the circuit diagram (see Fig. 5 on page 101).

### Experiment 2:

Fill the fuel cell with distilled water and place the model in the sunlight or illuminate the solar cells and the solar module with a suitable light source (e.g. 100 W light bulb at a distance of 30 cm).

What can you observe?

The pump moves and at the same time, hydrogen and oxygen are produced in the fuel cell. The motor and the fuel cell are connected in parallel. Both are therefore supplied with electric energy from the solar cells and from the solar module. The energy is sufficient to drive the motor and at the same time to produce hydrogen and oxygen.

**Experiment 3:**

Now wait until the hydrogen storage cylinder is around half-full and then cover up the the solar cells and the solar module or switch off the light source.

What can you observe now? Pay attention to the hydrogen storage cylinder too.

The model runs more slowly, but it does not stop and the fuel cell consumes hydrogen. If the light intensity reduces, the model is driven by the fuel cell. The pump now continues running, even after sunset or if the sun is concealed by a cloud.

The model now runs more slowly. This is because the fuel cell supplies a lower voltage than the solar cells and the solar module. An electric motor rotates more slowly if it is supplied with a lower voltage.

## Fuel cell technical data

### General

Operating temperature	10–40 °C
Storage temperature	5–40 °C
Gas storage capacity	2 × 15 ml

### Operation as electrolyzer

Operating voltage	1.4–2 V
Operating current	0–500 mA
Maximum hydrogen production rate	3.5 ml / min

### Operation as fuel cell

Operating voltage	0.5–0.9 V
Operating current	500 mA
Nominal power	250 mW

## Troubleshooting

Fault	Possible cause	Remedy
Unusually high voltage, if a load is connected to the fuel cell	Coat on the surface of the catalyst	The coat on the surface of the catalyst, which increases the initial output voltage of the fuel cell, disappears after a few seconds
No or very slow hydrogen production.	Incorrect connection between solar modules and fuel cell	Check connections and if necessary correct
	Light intensity too low	Increase the light intensity
	Fuel cell membrane is too dry	Leave the fuel cell filled with distilled water to stand for 30 minutes with the plugs facing upward
Low fuel cell output	Fuel cell membrane is too wet	Pour water out of the fuel cell and leave the fuel cell to stand open for a day



Handwriting practice lines consisting of multiple sets of horizontal dashed lines for writing.

# Hydro Cell Kit + Profi Oeco Power

Montagetipps

Tips for assembly

Tuyaux pour le montage

Montagetipps

Consejos para el montaje

"Dicas" para montagem

Consigli per il montaggio

Советы и рекомендации по сборке

装配建议

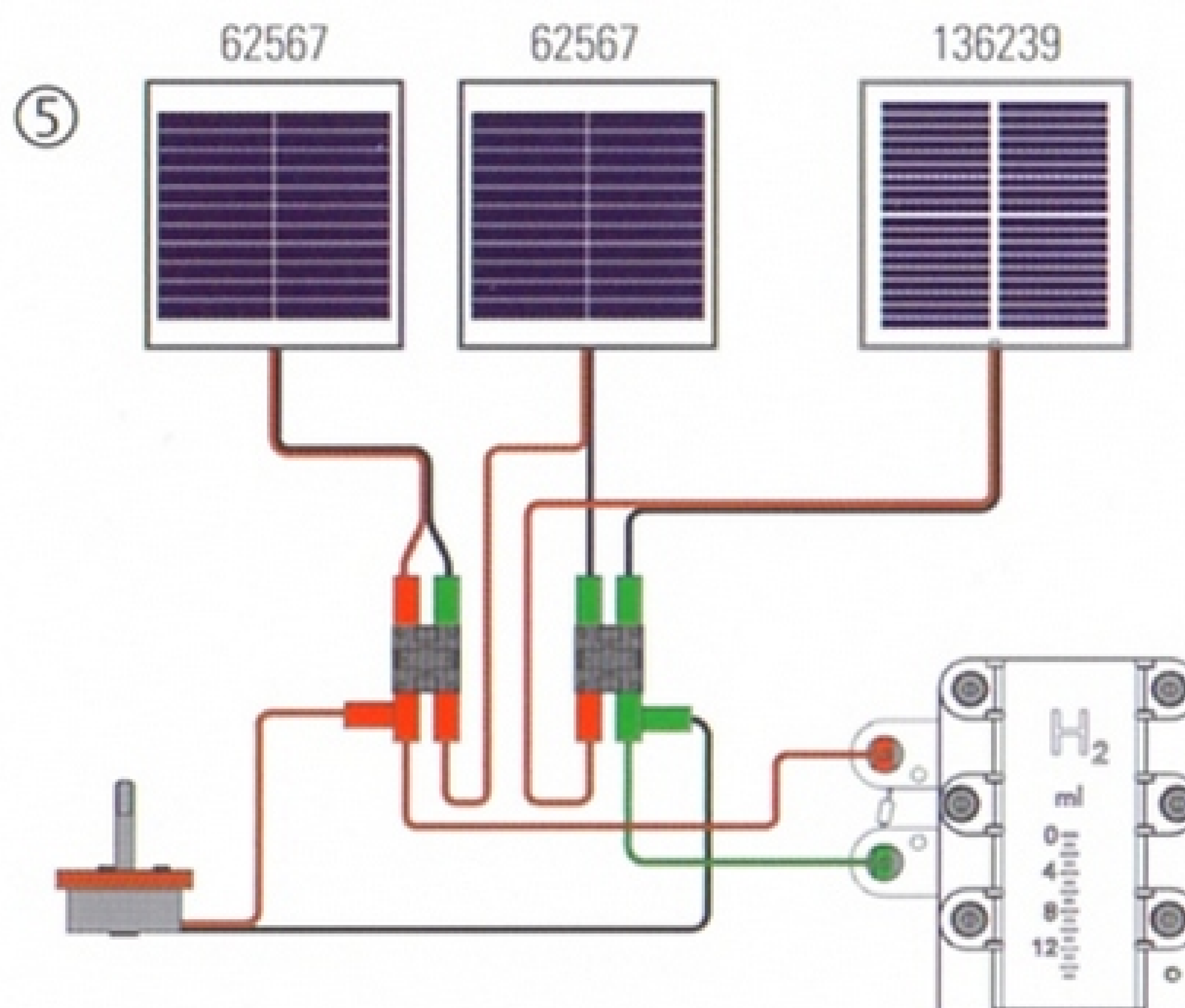
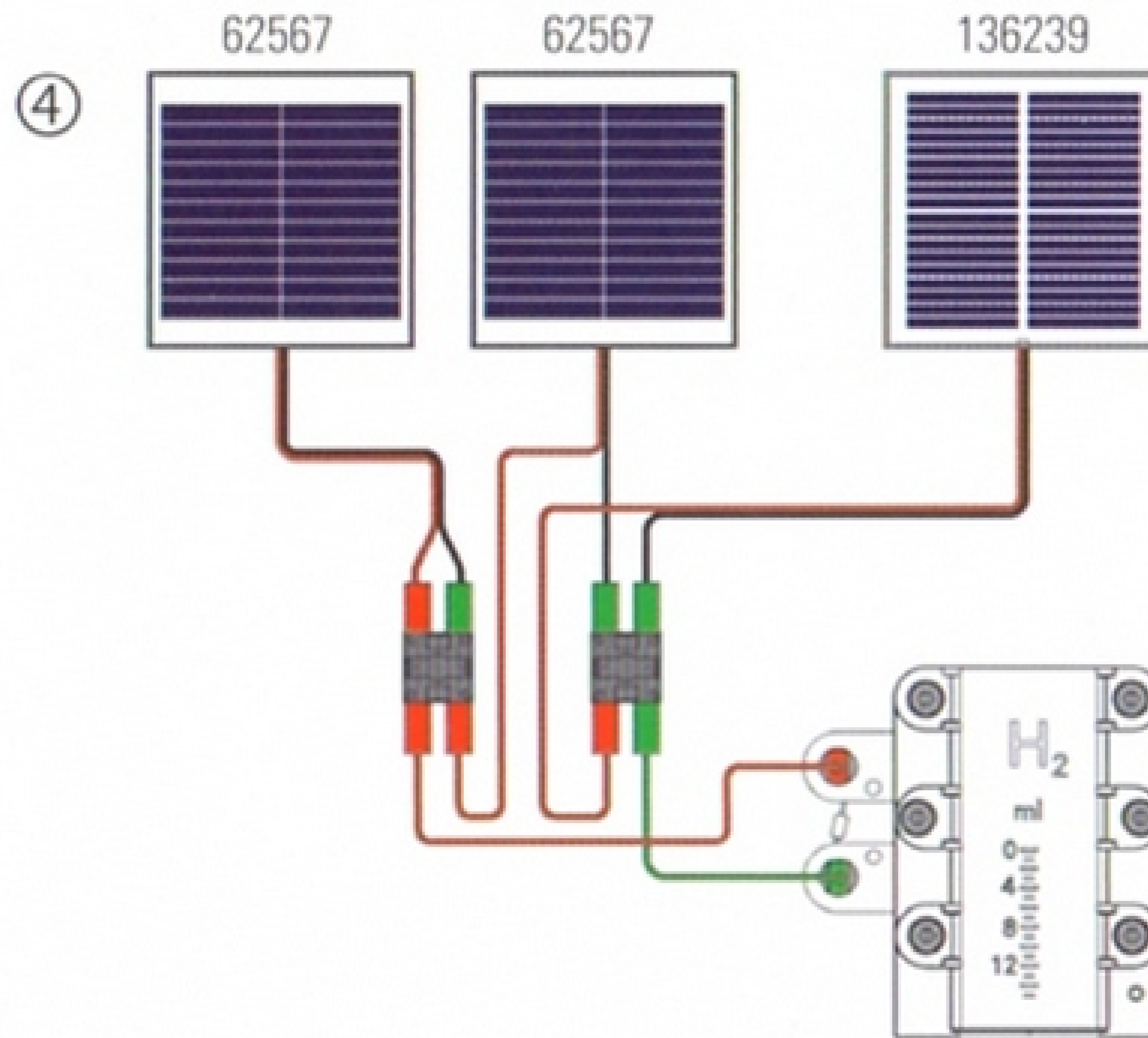

137413-07/09 · KW · Printed in Germany · Technische Änderungen vorbehalten · Subject to technical modification



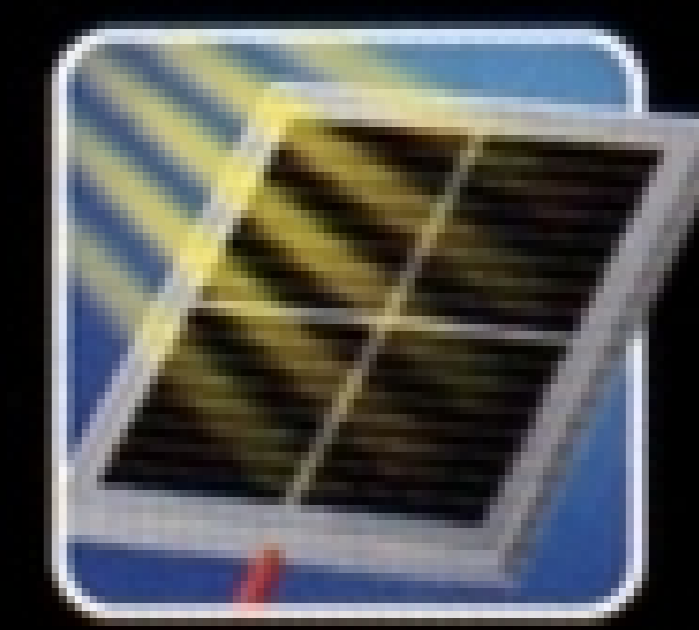

**fischertechnik** 

**PROFI**

fischertechnik GmbH  
Weinhalde 14-18  
72178 Waldachtal  
Germany

Phone: +49 74 43/ 12-4369  
Fax: +49 74 43/ 12-4591

info@fischertechnik.de  
www.fischertechnik.de

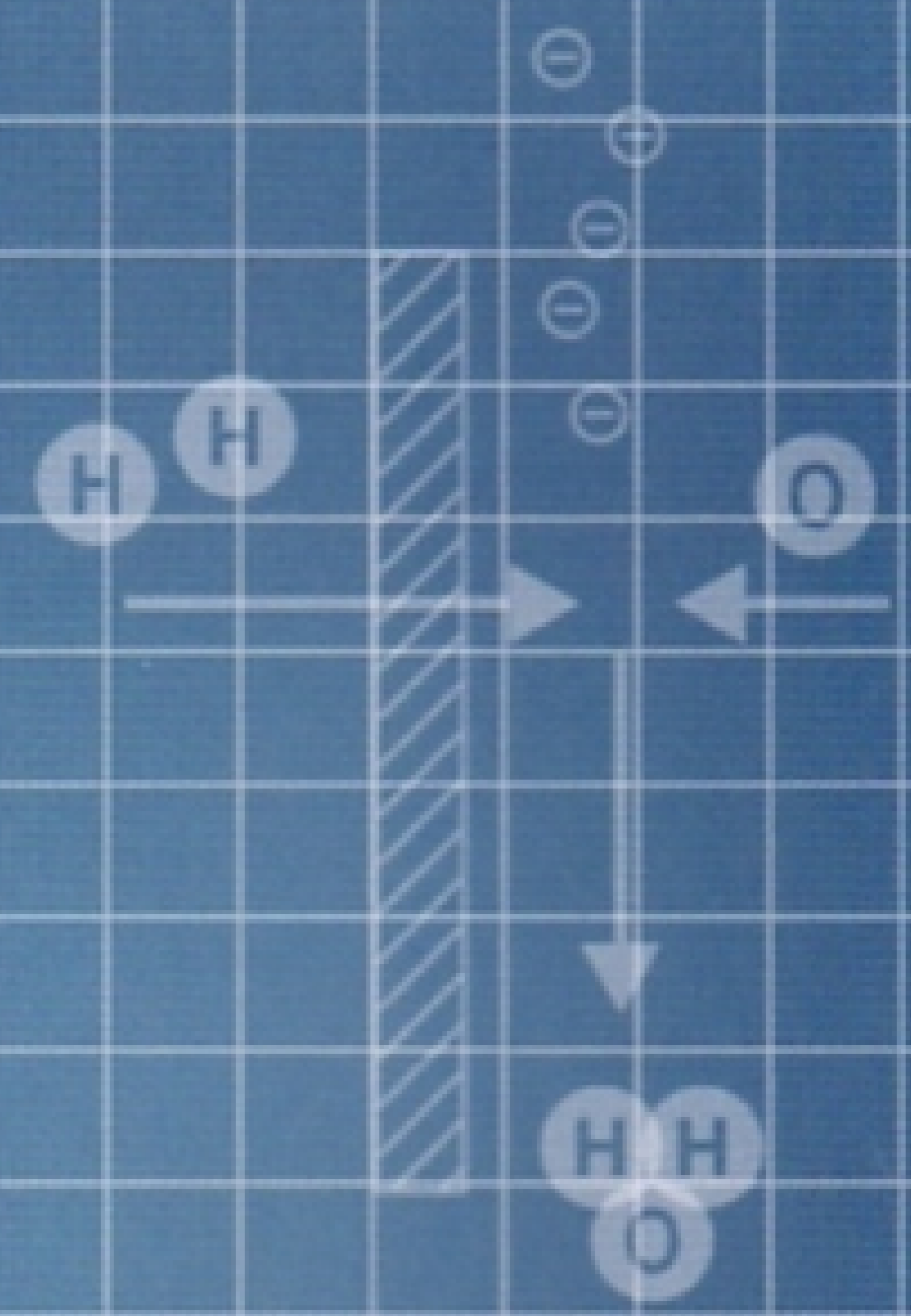
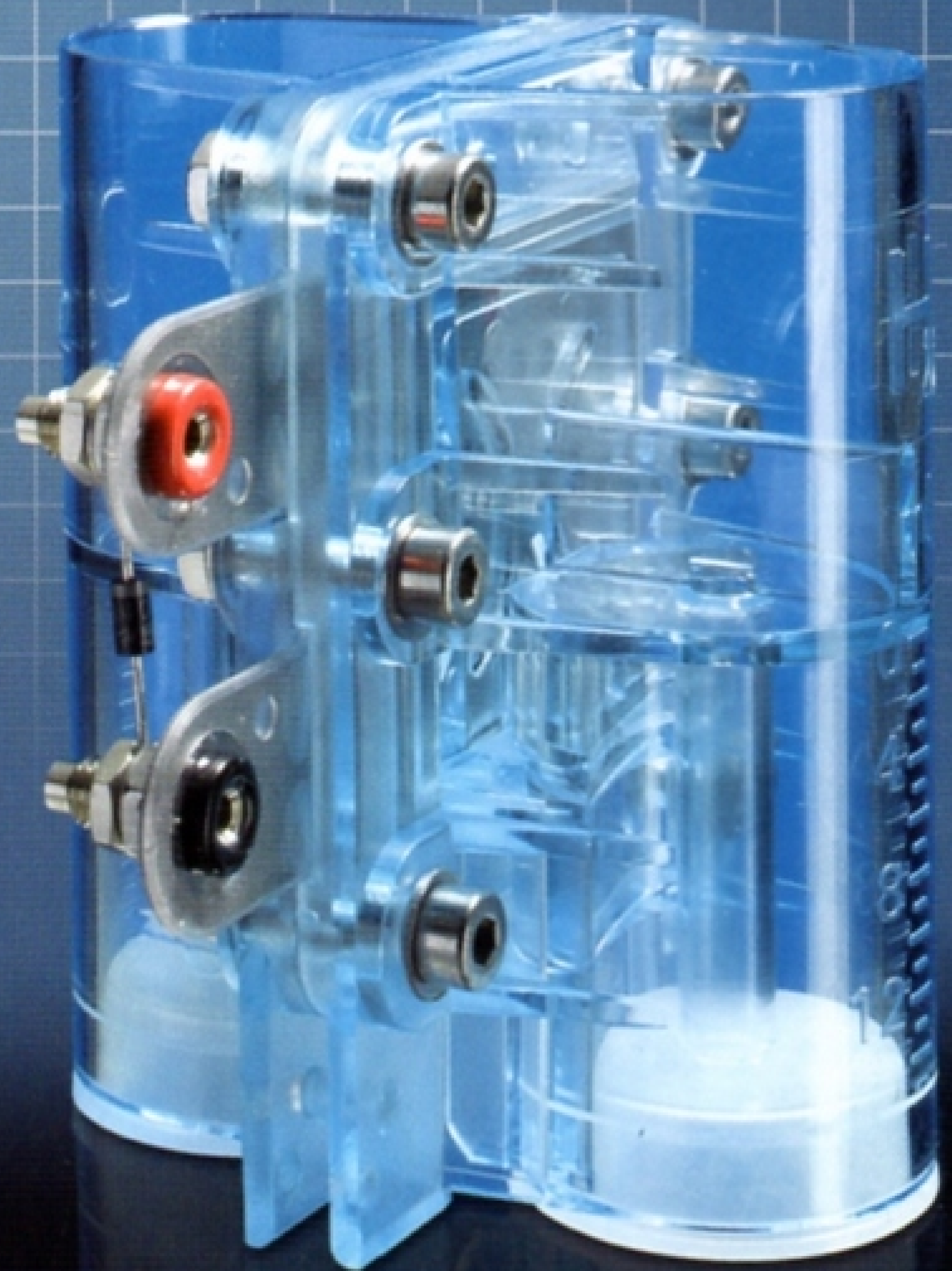
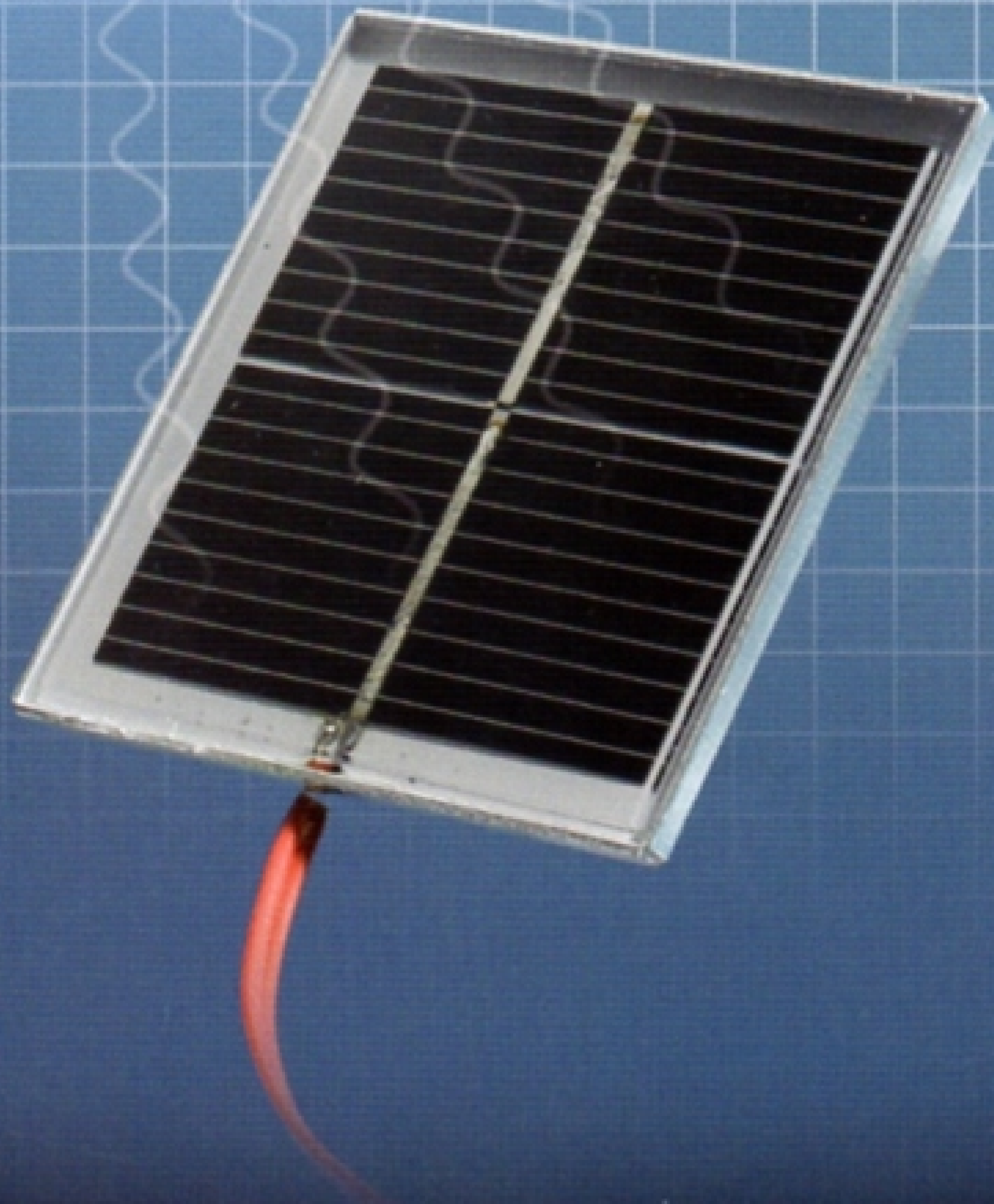

**Hydro Cell Kit**

Hydro Cell by  
**Heliocentris** 