

fischertechnik®

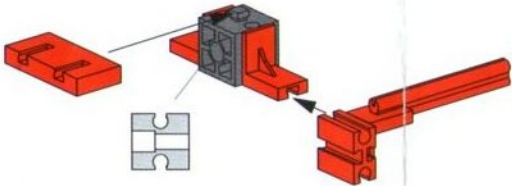

1



2

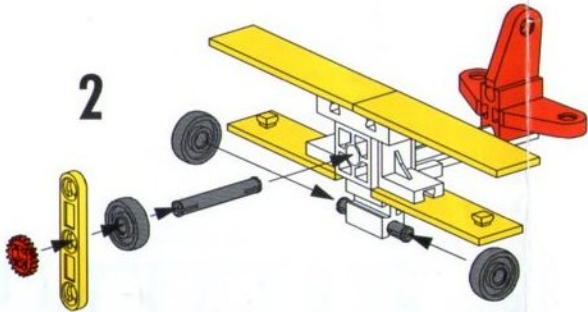

3

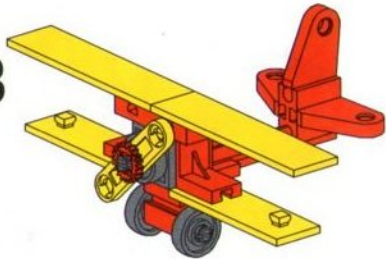

1

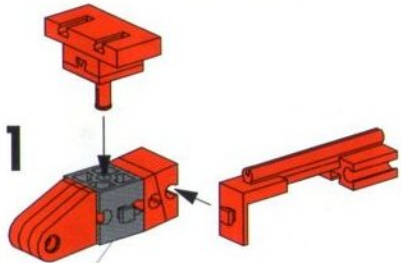

2

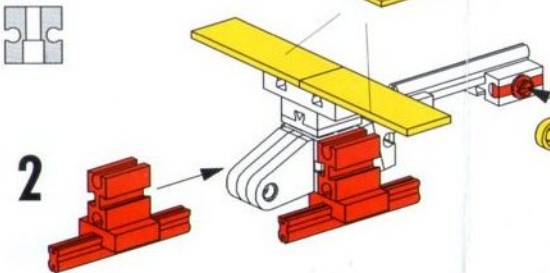

3

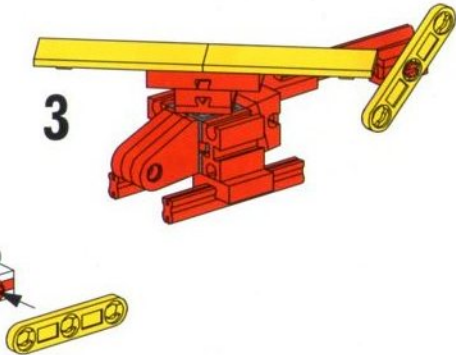

1

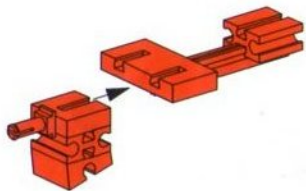



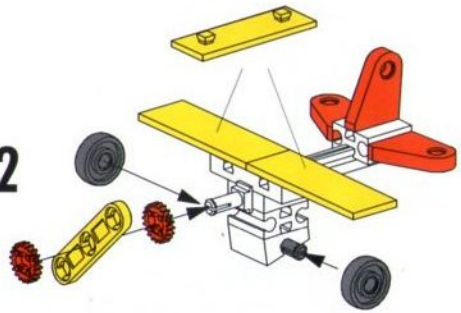



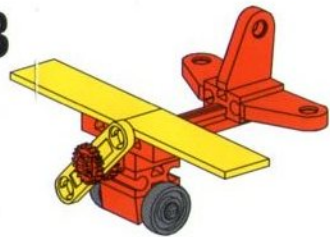

2







3



	31 124 1 x
	31 330 3 x
	31 848 1 x
	31 981 2 x
	32 321 1 x
	36 334 2 x

	36 573 3 x
	36 586 1 x
	36 919 2 x
	37 237 3 x
	37 468 3 x
	38 243 2 x

	38 423 3 x
	38 428 1 x
	38 473 3 x
	38 474 2 x
	38 538 1 x

Sollte ein Teil dieser Packung fehlen oder defekt sein, fordern Sie es bitte bei untenstehender Adresse unter Angabe der Produktionsnummer kostenlos an. Nicht die ganze Packung einsenden!

Should part of this package be missing or defective, write to the following address for a free replacement stating the production number. Do not send the entire package!

Au cas où une pièce de cet emballage manquerait ou serait défectueuse, veuillez demander son envoi gratuit à l'adresse indiquée ci-dessous en fournissant le N° de production. Ne pas expédier la boîte complète!

Wanneer een deel van deze verpakking ontbreekt of defect is, kunt u het op onderstaand adres onder vermelding van de productienr. Stuur niet de hele verpakking op!

En caso de faltar o estar defectuosa una pieza de esta caja, solicítela gratuitamente a la dirección abajo mencionada, indicando el N° de producción. ¡No envíe la caja completa!

Caso esteja faltando alguma peça na embalagem ou caso a mesma apresente defeito, solicite o envio gratuito no endereço abaixo, indicando a N.º de fabricação.

Não envie a embalagem completa!

fischertechnik Service Weinhalde 14-18, D-72178 Waldachtal

Tel: +49 (0)7443/12-4369, Fax: +49 (0)7443/12-4591

E-mail: info@fischertechnik.de; www.fischertechnik.de

Prod.-No.: 18073111B