

TRACTOR

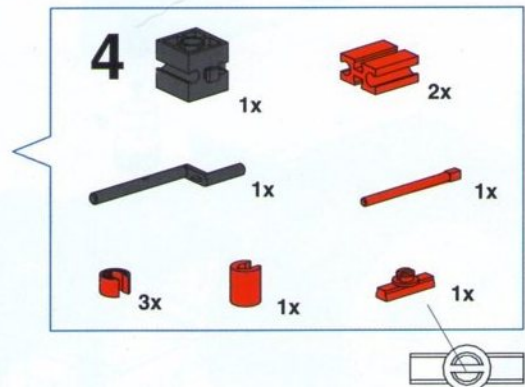

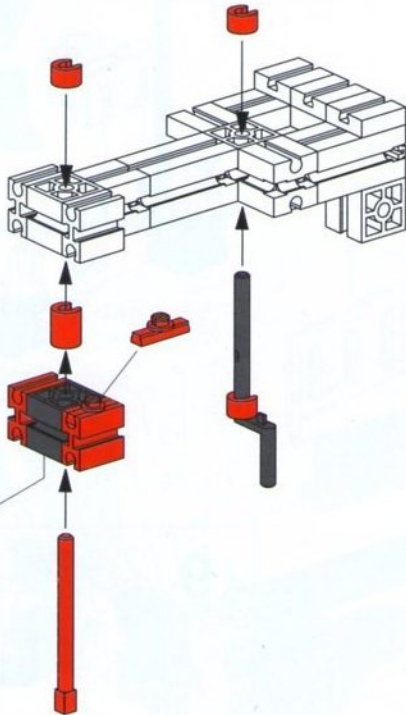

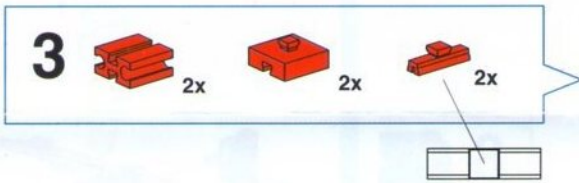

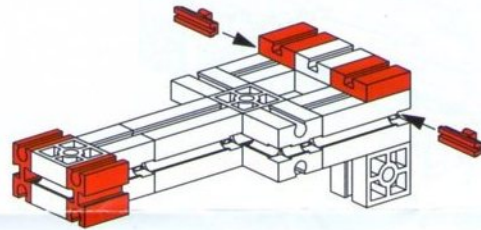
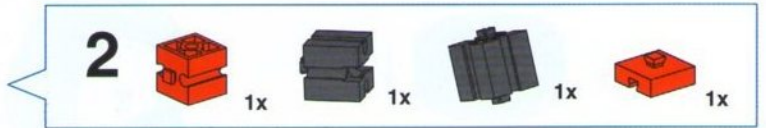
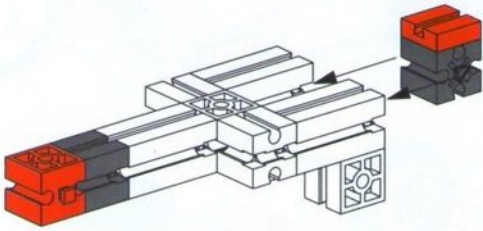
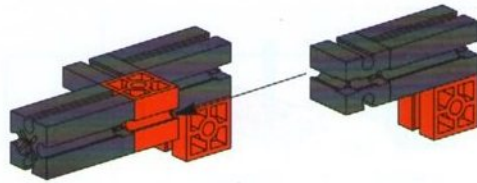

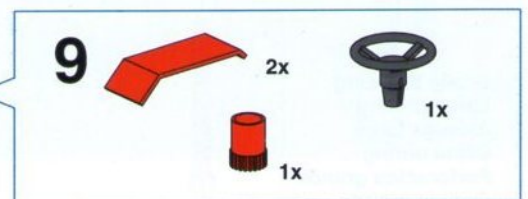
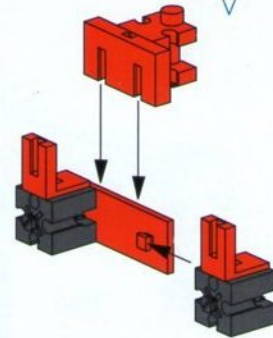
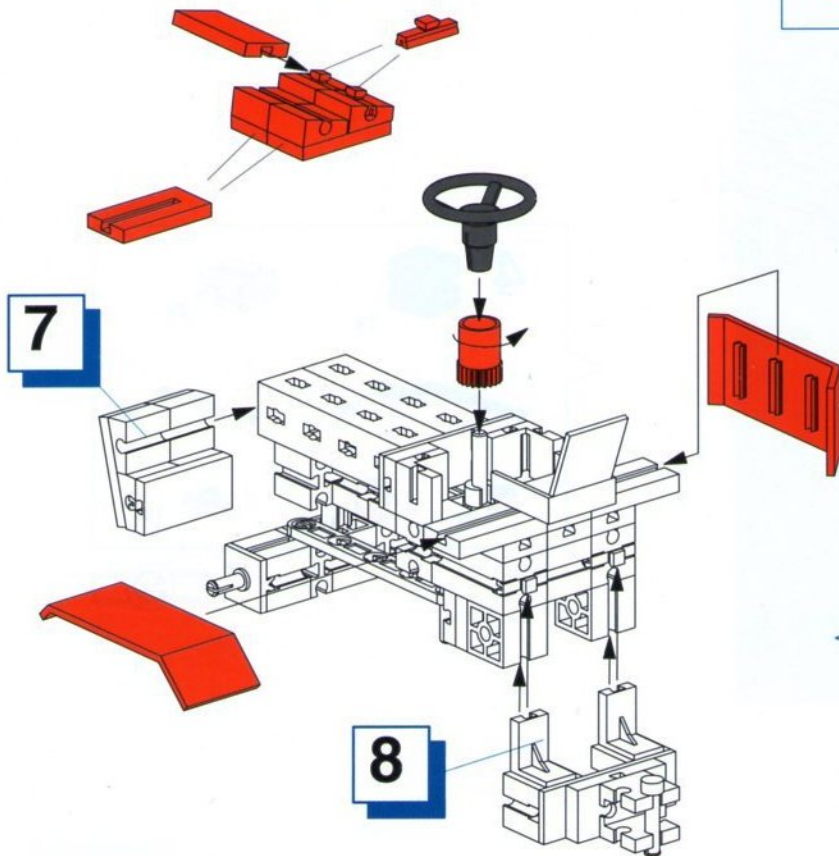
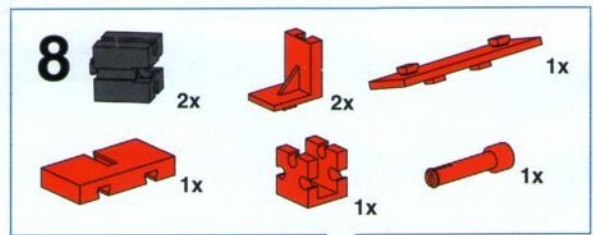
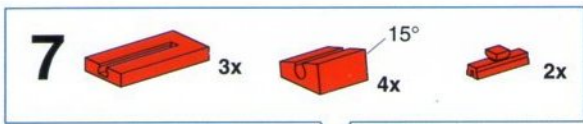
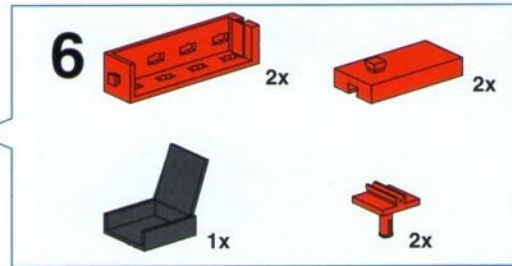
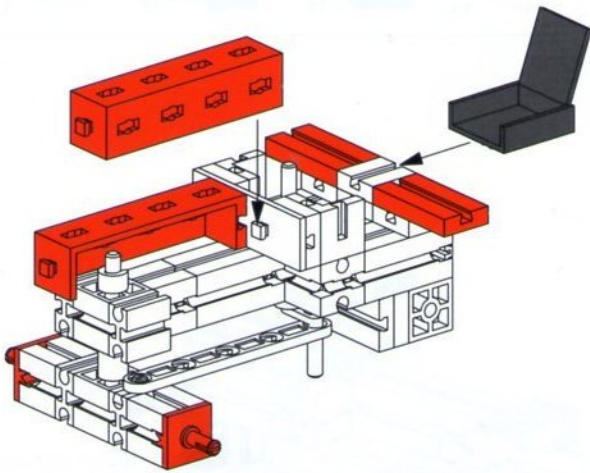
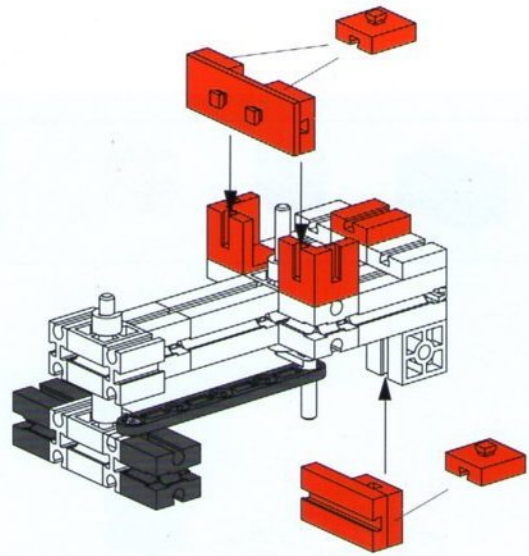
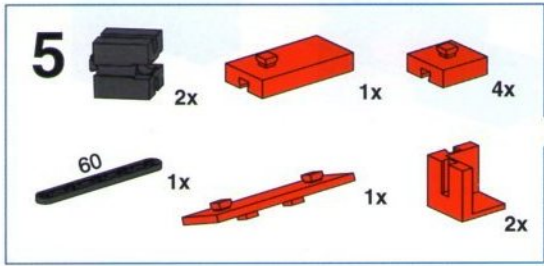

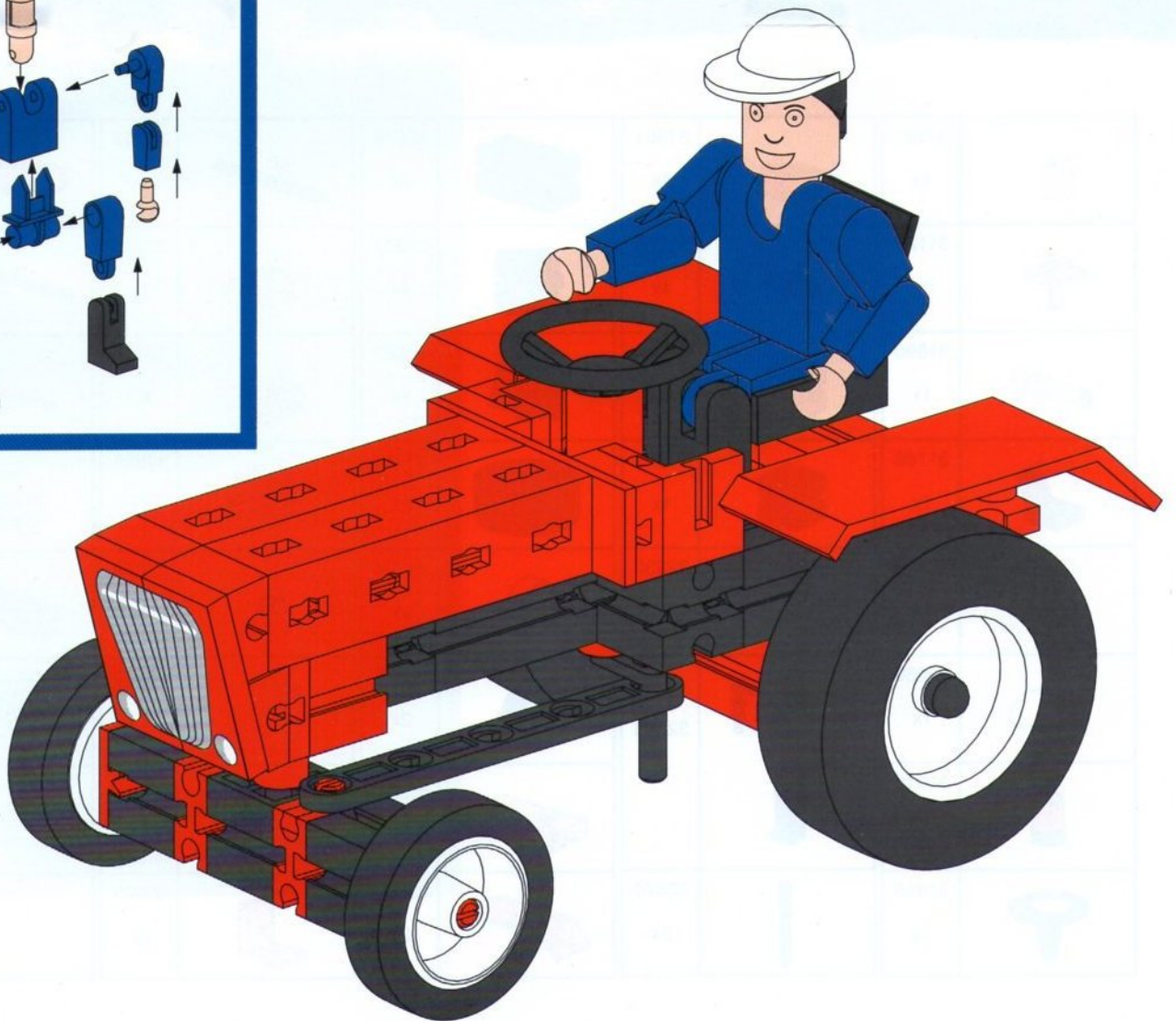
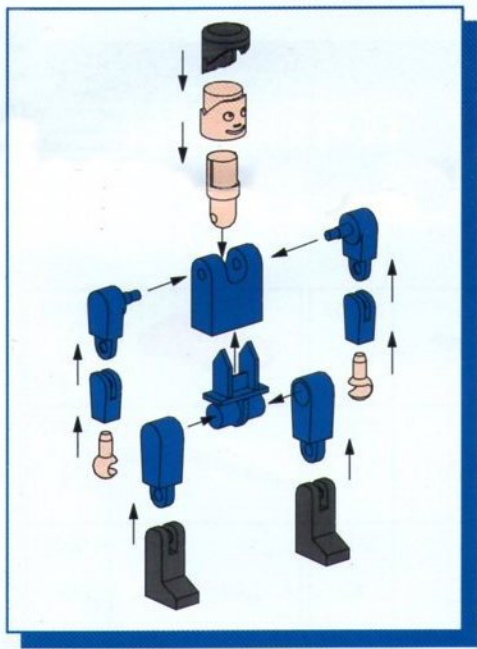
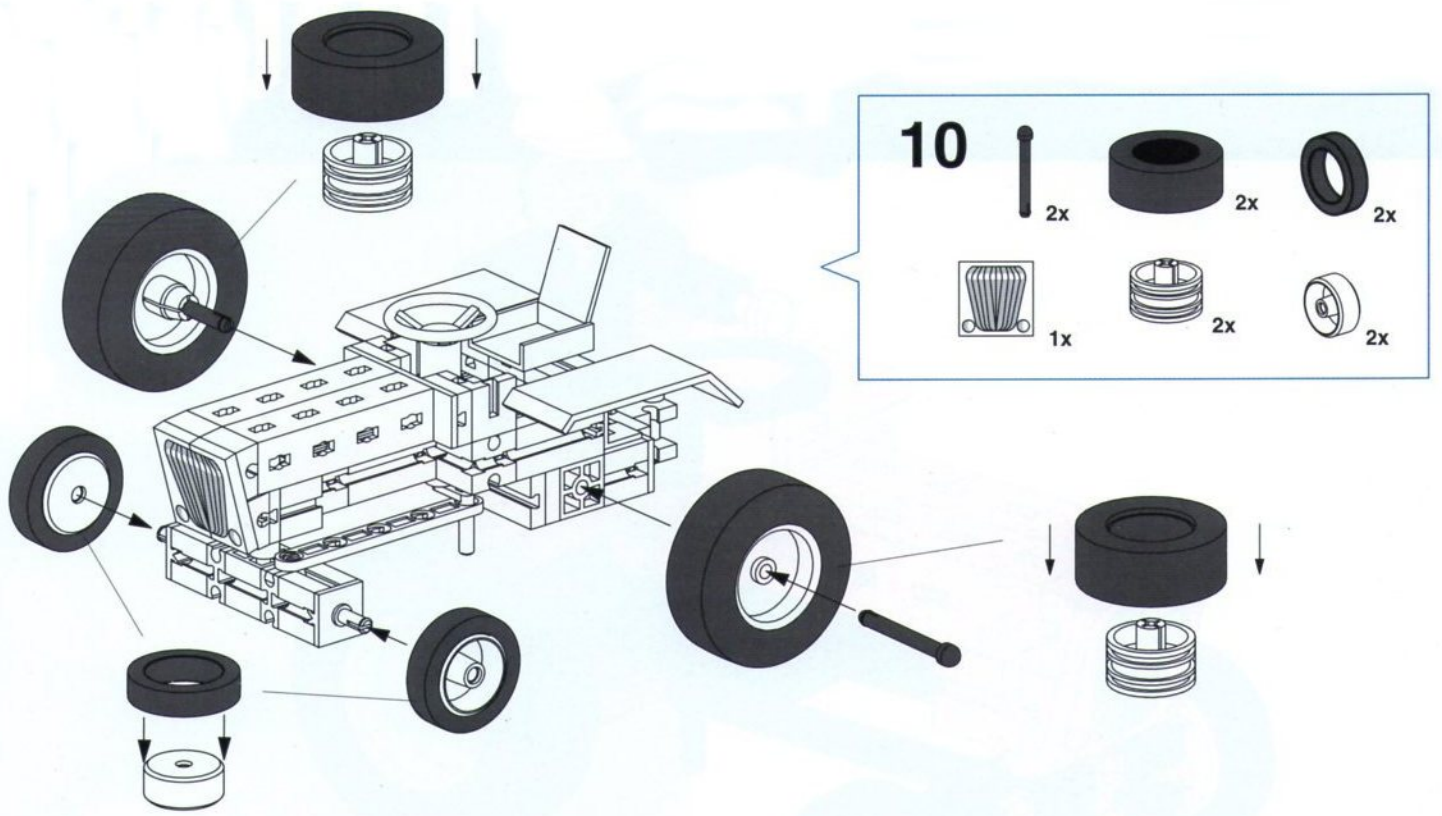





















fischertechnik 

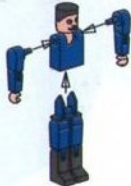

Große Bohrung
Large drilling
Alésage large
Grote boring
Perforación grande
Orificio grande





	31023 1x	 15°	31981 4x		32879 3x	 60	36952 1x		38428 1x
	31124 2x		31982 4x		32881 7x		37237 7x		38447 1x
	31690 1x		32064 4x		32882 1x		37468 4x		78237 1x
	31766 1x		32321 1x		32913 2x		37636 1x		78727 2x
	31848 1x		32330 3x		34994 2x		37679 3x		78728 2x
	31850 1x		32853 1x		34995 2x		38240 2x		78762 1x
	31915 1x			35049 3x		38277 2x			
	31916 1x		32870 2x		35050 2x		38423 2x		