













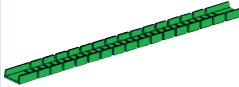

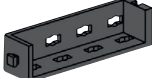



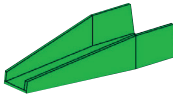

# Dynamic Tuning Set

Einzelteilübersicht  
Spare parts list  
Liste des pièces détachées

Onderdelenoverzicht  
Lista da piezas  
Resumo de peça individual

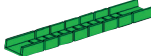
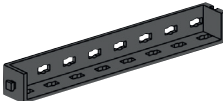
Singoli componenti  
Перечень деталей  
零件概览

	31 011 2 x		36 323 4 x		119 850 2 x
	31 981 4 x		36 920 4 x		143 234 10 x
	31 982 6 x		36 921 2 x		144 262 8 x
	32 071 4 x		36 922 4 x		151 715 4 x
	32 850 4 x		36 973 4 x		151 716 2 x
	35 049 4 x		37 237 4 x		151 717 2 x
	36 248 100 x		38 240 4 x		155 901 4 x
	36 293 2 x		38 428 4 x	Erfinder Flexprofil 143 234 + 155 901 Entwickler 90° Kurve 151 715 und Wechselweiche 151 716+151 717 Design und Konzeption Andreas Lehrberger	

- Alle Einzelteile, insbesondere bewegliche Teile sind falls notwendig zu warten und zu reinigen.
- All components, especially moving parts, should be maintained and cleaned as necessary.
- Toutes les pièces détachées et en particulier les pièces mobiles, sont, si nécessaire, à entretenir et à nettoyer.
- Alle onderdelen, vooral de bewegende delen, kunnen, indien noodzakelijk, onderhouden en gereinigd worden.
- Es necesario limpiar y mantener en buen estado todas las diferentes piezas -especialmente las piezas móviles.

- Caso necessário, todas as peças individuais, especialmente peças móveis, tem que ser submetidas à manutenção e ser limpidas.
- Se necessario, tutti i singoli componenti, soprattutto le parti mobili, si devono eventualmente sottoporre a manutenzione e pulizia.
- Все детали, особенно подвижные, требуют ухода и чистки.
- 必要时应保养和清洁所有零件，尤指运动部件。

**Montagetipps**  
**Tips for assembly**  
**Tuyaux pour le montage**

**Montagetips**  
**Consejos para el montaje**  
**"Dicas" para montagem**

**Consigli per il montaggio**  
**Советы по сборке**  
**装配建议**

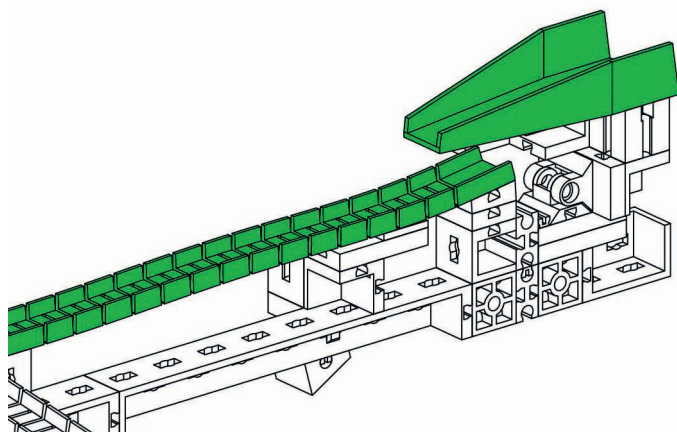
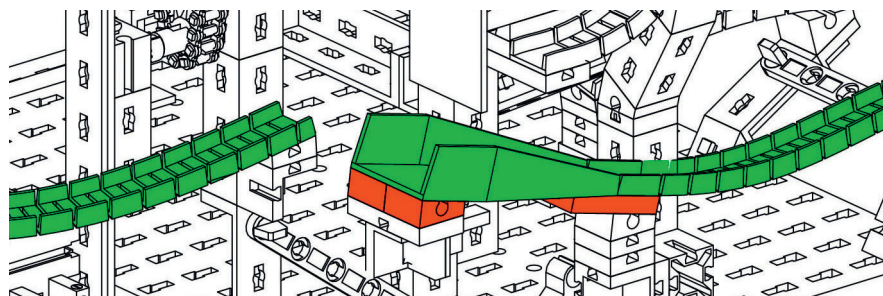
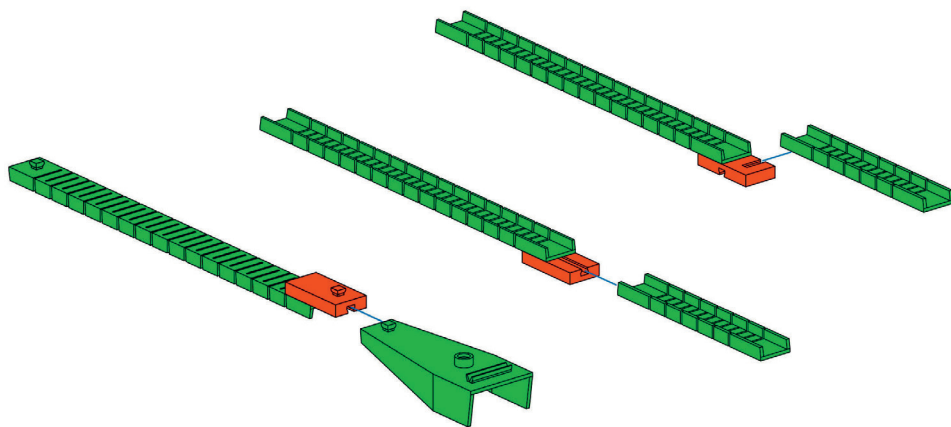

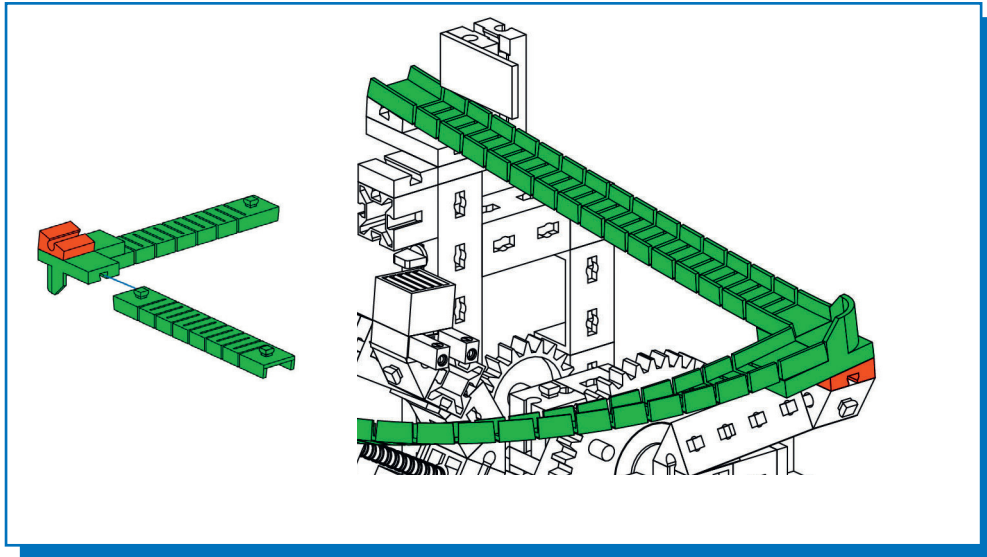
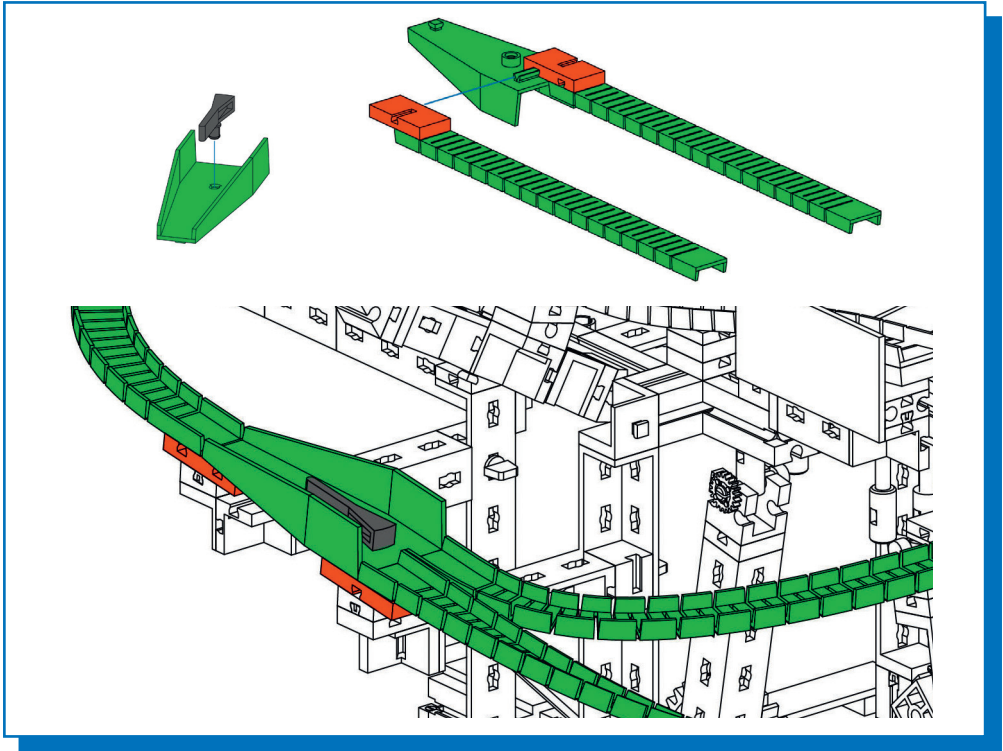

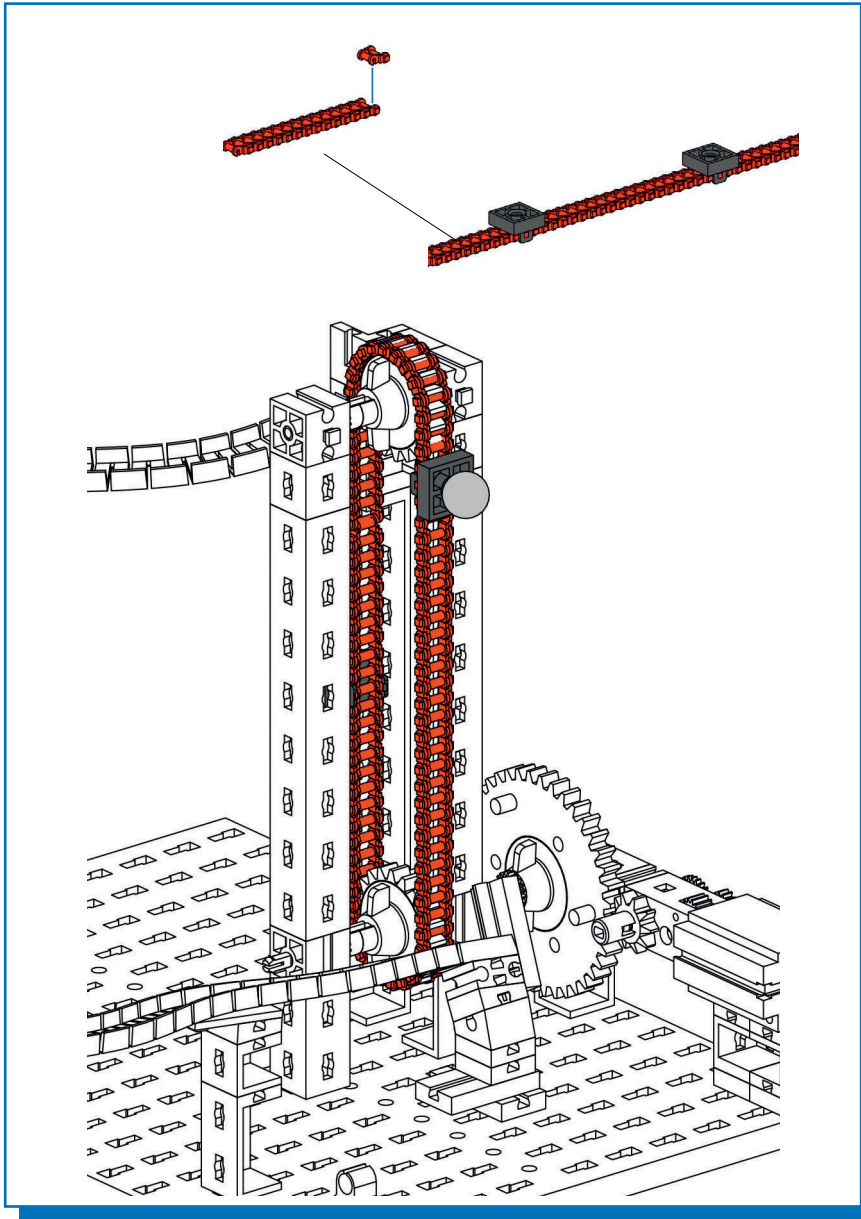

Nur farbig dargestellte Teile im Set enthalten / Set contains only parts shown in color / Seules les pièces représentées en couleur sont contenues dans le kit / Alleen in kleur weergegeven onderdelen zijn bij de set inbegrepen / Solo las piezas en color están incluidas en el set / Apenas as peças representadas em cores estão contidas no kit / Il kit comprende solo i particolari raffigurati a color / В комплект входят только показанные цветными детали / 用颜色标出的零件才包含在套件中