

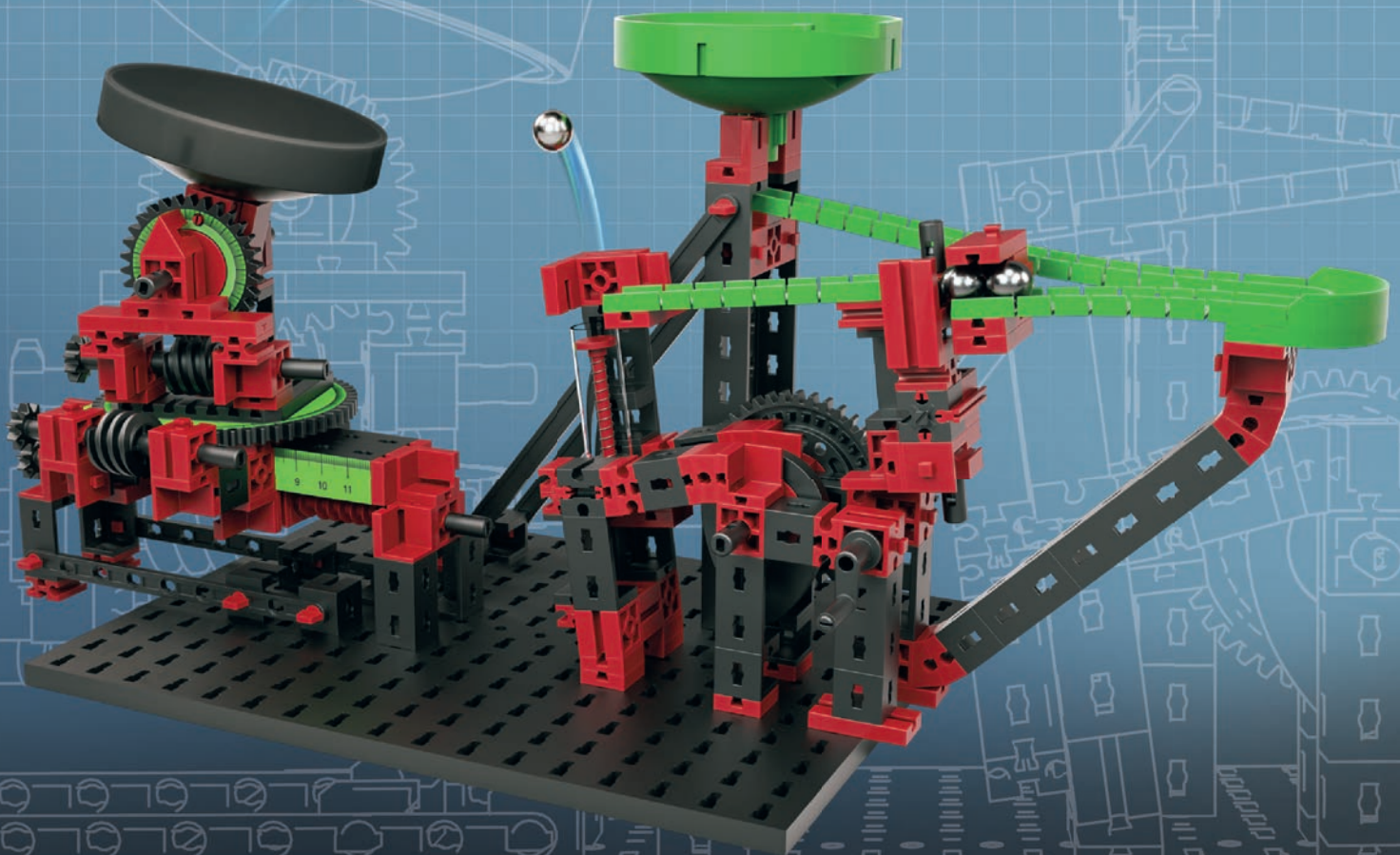

fischertechnik 

PROFI

Bauanleitung
Assembly instruction
Instructions de montage
Bouwhandleiding
Instrucciones de construcción
Manual de montagem
Istruzioni di montaggio
Инструкция по сборке
安装说明书



Dynamic XM

3 MODELS

Inhalt
Contents
Contenu

Inhoud
Contenido
Conteúdo

Contenuto
Содержание
目录

Einzelteilübersicht / Spare parts list / Liste des pièces détachées / Onderdelenoverzicht / Lista da piezas / Resumo de peça individual /
Singoli componenti / Перечень деталей / 零件概览 1

Montagetipps / Tips for assembly / Tuyaux pour le montage / Montagetips / Consejos para el montaje / "Dicas" para montagem /
Consigli per il montaggio / Советы по сборке / 装配建议 2

Parcours 1 / Obstacle course 1 / Parcours 1 / Parcours 1 /
Pista de recorrido 1 / Circuito 1 / Circuito 1 / Маршрут 1 /
滚珠弯道 1 4

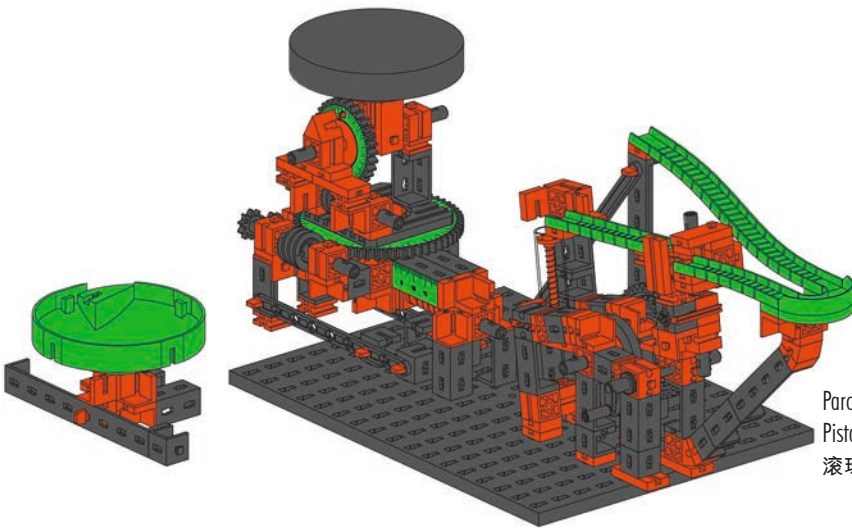
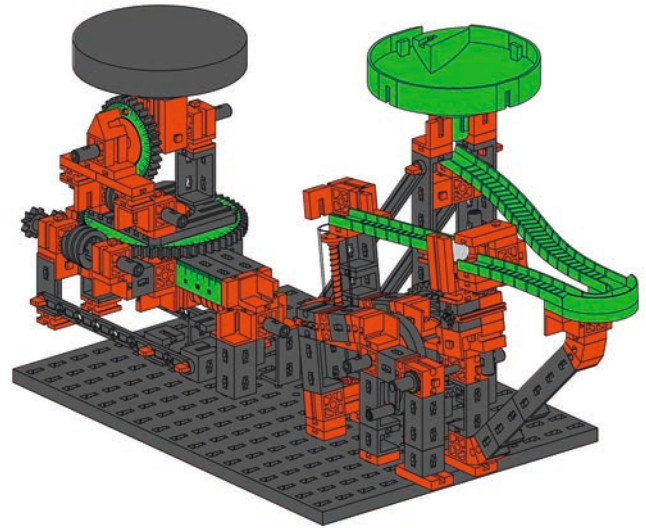

Parcours 2 / Obstacle course 2 / Parcours 2 / Parcours 2 /
Pista de recorrido 2 / Circuito 2 / Circuito 2 / Маршрут 2 /
滚珠弯道 2 22



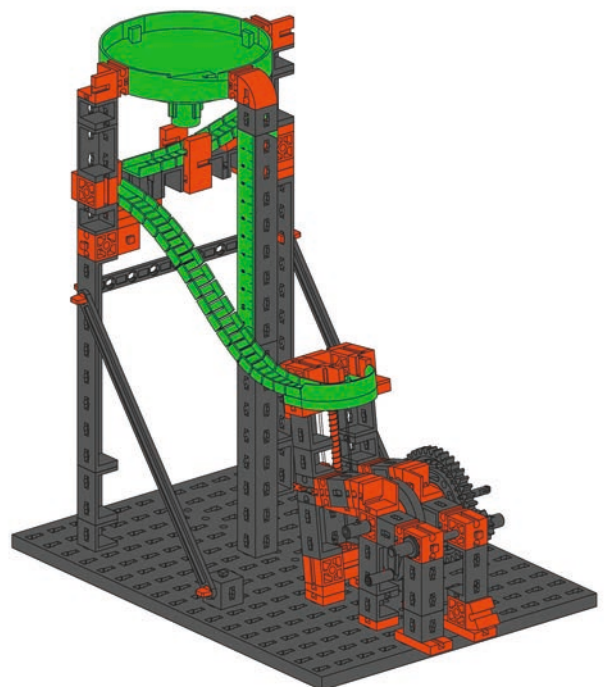













Parcours 3 / Obstacle course 3 / Parcours 3 / Parcours 3 /
Pista de recorrido 3 / Circuito 3 / Circuito 3 / Маршрут 3 /
滚珠弯道 3 24









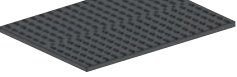







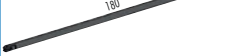

Einzelteilübersicht
Spare parts list
Liste des pièces détachées















Onderdelenoverzicht
Lista da piezas
Resumo de peça individual

Singoli componenti
Перечень деталей
零件概览

	31 011 2 x
	31 022 1 x
	31 058 3 x
	31 061 1 x
	31 330 1 x
	31 390 1 x
	31 391 1 x
	31 597 3 x
	31 771 1 x
	31 915 1 x
	31 918 1 x
	31 981 4 x
	31 982 21 x
	32 064 27 x
	32 071 6 x
	32 881 3 x
	32 985 1 x

	35 031 3 x
	35 049 11 x
	35 063 4 x
	35 065 1 x
	35 066 2 x
	35 072 2 x
	35 073 8 x
	35 087 1 x
	35 088 1 x
	35 466 1 x
	35 945 4 x
	36 264 1 x
	36 293 4 x
	36 323 16 x
	36 334 1 x
	36 819 1 x
	36 920 17 x

	36 921 1 x
	36 922 11 x
	36 950 12 x
	36 952 1 x
	36 973 2 x
	37 237 16 x
	37 468 17 x
	37 527 1 x
	37 679 3 x
	37 858 1 x
	37 925 1 x
	37 926 3 x
	38 240 25 x
	38 246 1 x
	38 423 1 x
	38 428 7 x
	38 546 3 x

	105 196 1 x
	119 753 2 x
	137 677 1 x
	143 234 1 x
	144 262 5 x
	155 901 2 x
	155 902 1 x
	158 962 1 x
	163 201 1 x
	167 983 1 x
	167 984 1 x
	167 985 1 x
	168 721 1 x
	169 194 1 x

Montagetipps
Tips for assembly
Tuyaux pour le montage

Montagetips
Consejos para el montaje
"Dicas" para montagem

Consigli per il montaggio
Советы по сборке
装配建议

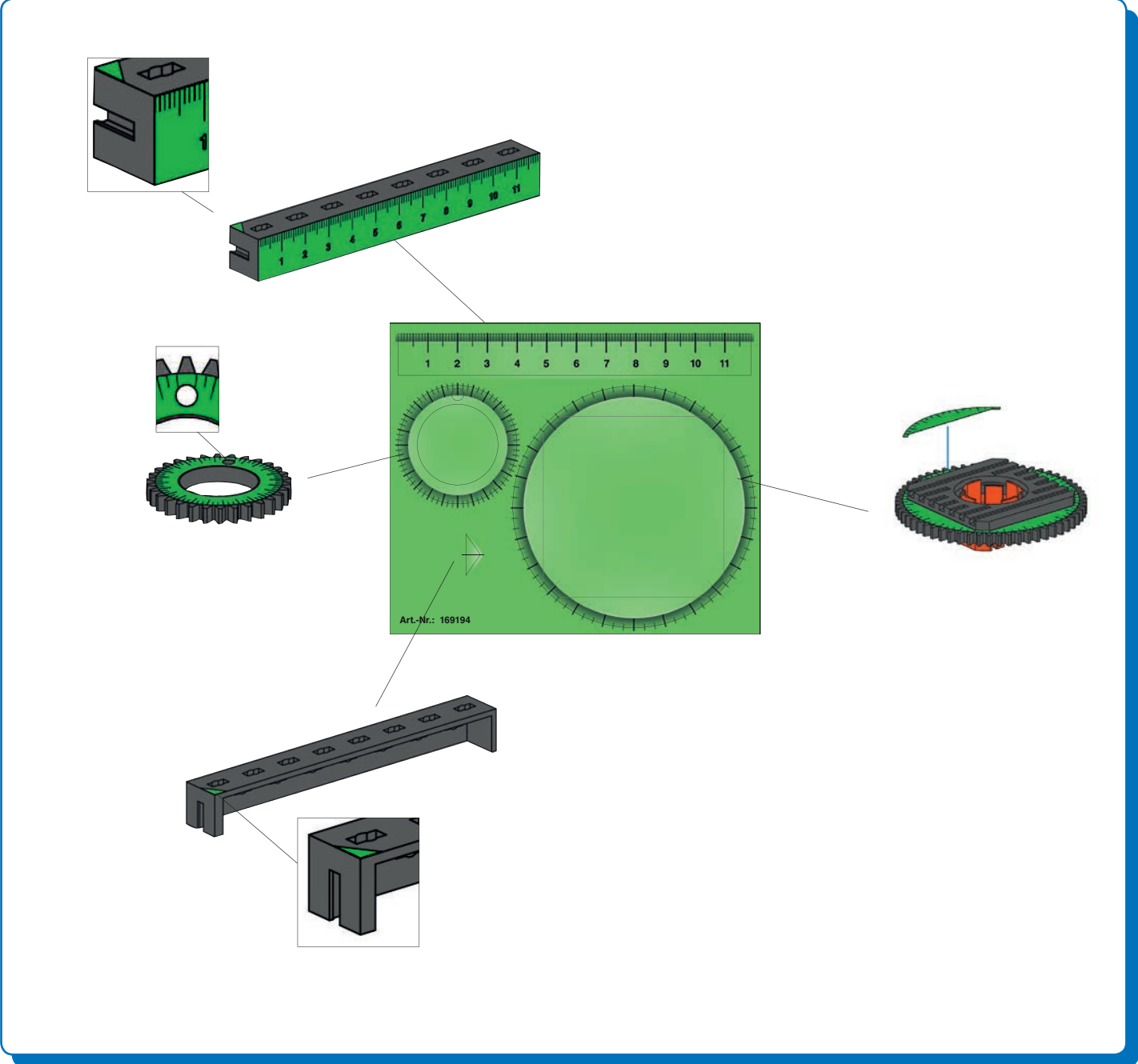
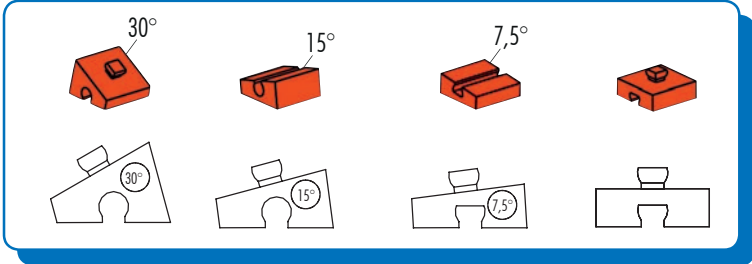

Sicherheitshinweise
Safety Information
Consignes de sécurité

Veiligheidsrichtlijnen
Indicaciones de seguridad
Observações sobre segurança

Informazioni per la sicurezza
Указания по технике безопасности
安全指南

- Trampolinbespannung: Hergestellt aus Naturkautschuklatex.
- Launching pad cover: Made from natural rubber latex.
- Toile du trampoline : fabriquée en latex de caoutchouc naturel
- Trampoline springmat: vervaardigd van natuurlijk rubberlatex.
- Revestimiento del trampolín: fabricado en látex natural.
- Entelagem da cama elástica: fabricado a partir de borracha natural.
- Copertura del trampolino: prodotta in lattice di gomma naturale.
- Натяжка батута: изготовлена из натурального латекса.
- 蹦床床套：由天然橡胶乳胶制成。

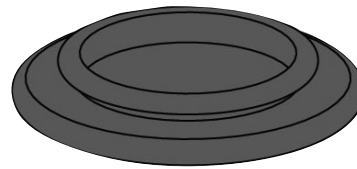

- Achtung! Verletzungsgefahr an Bauteilen mit funktionsbedingten scharfen Kanten und Spitzen!
- Caution! Be careful not to hurt yourself on components with sharp or pointed edges!
- Attention! Risque de blessure sur les éléments comportant des arêtes et o pointes vives indispensables au bon fonctionnement!
- Let op! U kunt zich bezeren aan bouwstenen met scherpe randen of punten!
- Attenzione! Esiste il pericolo di lesione con i pezzi di costruzione che hanno bordi e punte spigolosi necessari per la funzionalità del pezzo!
- Atenção! Perigo de ferimentos em peças componentes com cantos vivos e pontas obrigatórios para o funcionamento!
- Attenzione! Pericolo di lesioni dovute a componenti con spigoli vivi e punte per motivi funzionali!
- Будьте осторожны! Об острые края деталей и и наконечники можно порезаться!
- 注意！因功能需要而带有锋利的棱边和尖角的部件可能会带来受伤危险！

- Alle Einzelteile, insbesondere bewegliche Teile sind falls notwendig zu warten und zu reinigen.
- All components, especially moving parts, should be maintained and cleaned as necessary.
- Toutes les pièces détachées et en particulier les pièces mobiles, sont, si nécessaire, à entretenir et à nettoyer.
- Alle onderdelen, vooral de bewegende delen, kunnen, indien noodzakelijk, onderhouden en gereinigd worden.
- Es necesario limpiar y mantener en buen estado todas las diferentes piezas - especialmente las piezas móviles.
- Caso necessário, todas as peças individuais, especialmente peças móveis, tem que ser submetidas à manutenção e ser limpadas.
- Se necessario, tutti i singoli componenti, soprattutto le parti mobili, si devono eventualmente sottoporre a manutenzione e pulizia.
- Все детали, особенно подвижные, требуют ухода и чистки.
- 必要时应保养和清洁所有零件，尤指运动部件。



Hinweise zum Umweltschutz / Instructions for Environmental Protection / Remarques de protection de l'environnement / Bescherming van het milieu / Notas con respecto a la protección del medio ambiente / Instruções para a proteção do meio ambiente / Indicazioni sulla tutela ambientale / Указания по охране окружающей среды / 有关环保的提示：

www.fischertechnik.de/environment

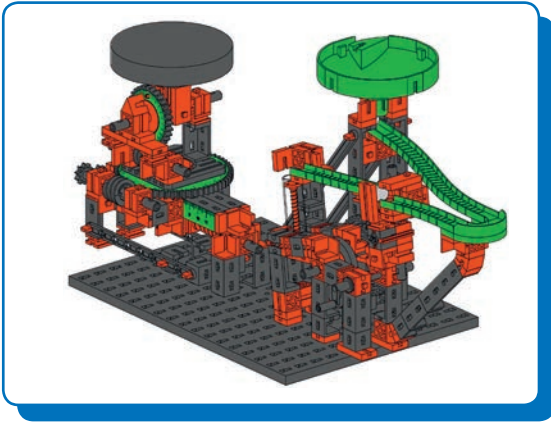

Parcours 1
Obstacle course 1
Parcours 1

Parcours 1
Pista de recorrido 1
Circuito 1

Circuito 1
Маршрут 1
滚珠弯道 1

1

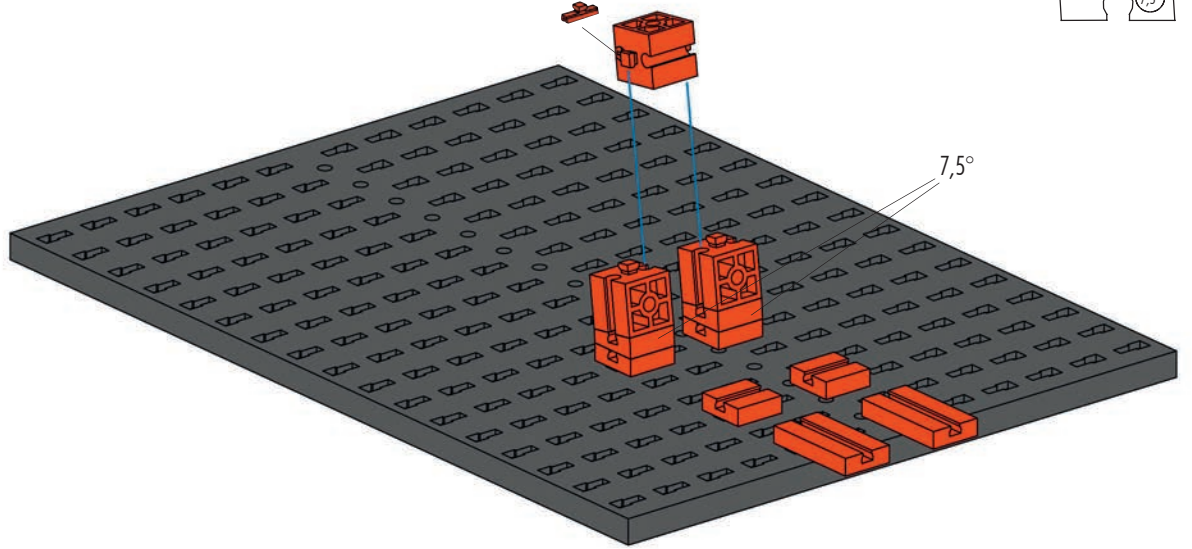

2

3

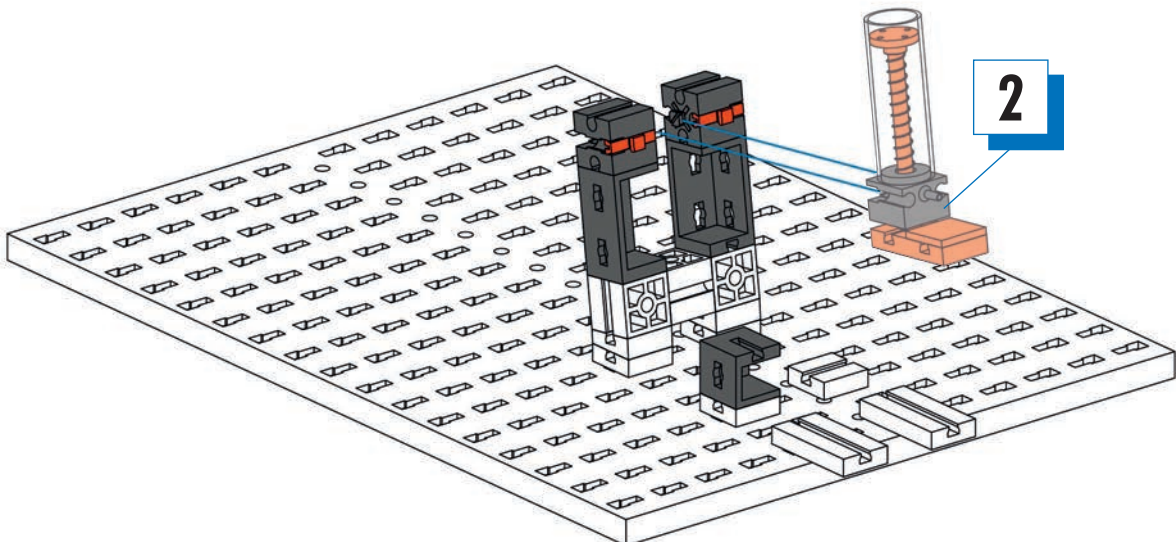

4  1x  1x  1x  1x  1x

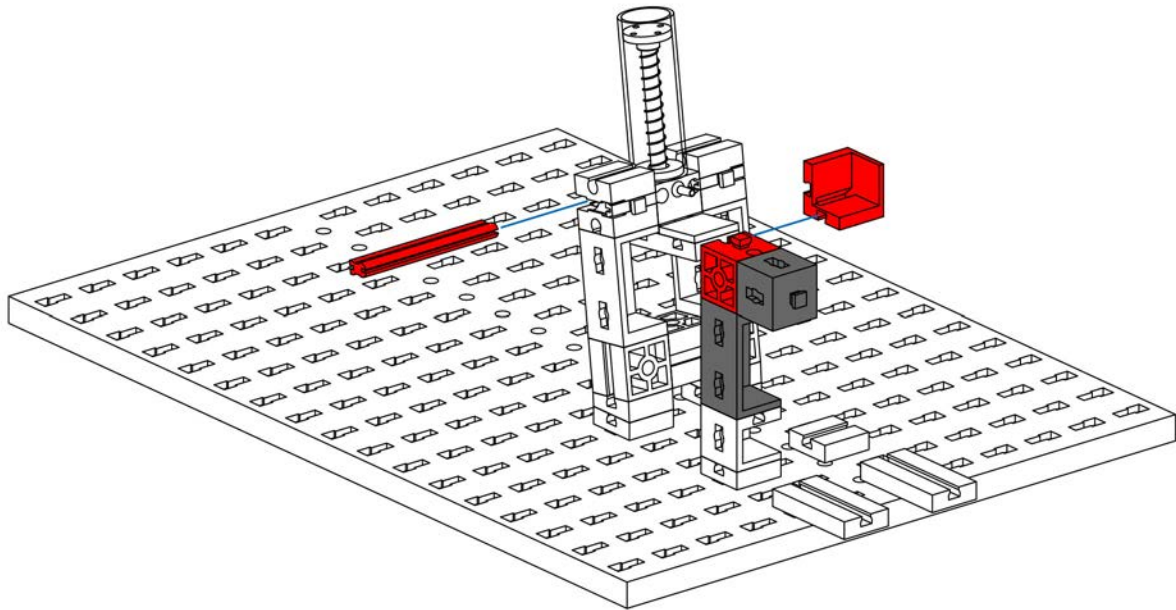



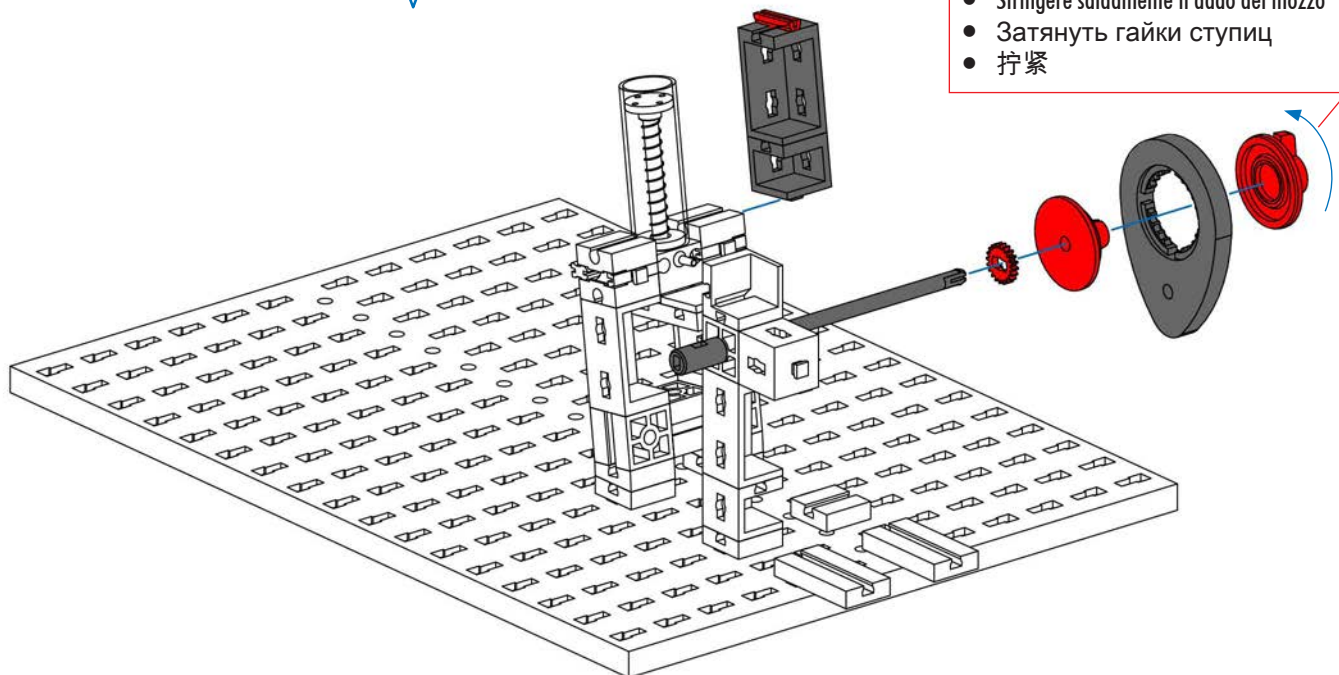



5  1x  1x  1x  1x  1x  1x  1x  1x  1x





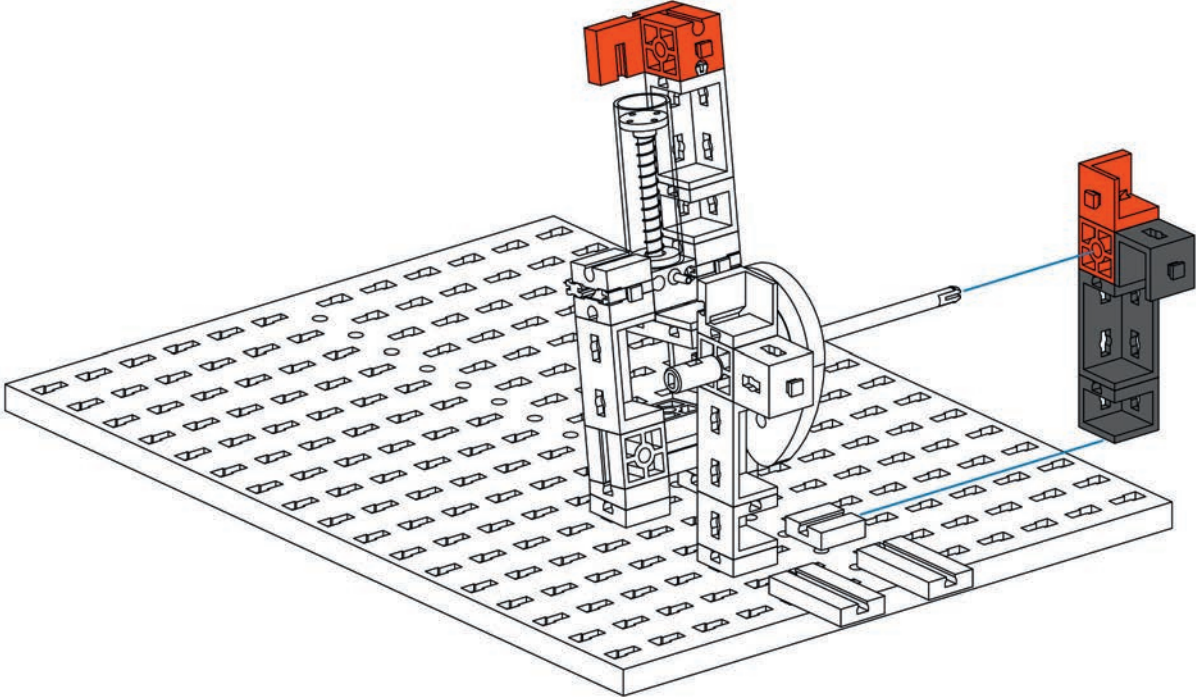

- Nabenmutter sehr fest anziehen
- Fasten the hub nut very tightly
- Serrer l'écrou du moyeu très serré
- Draai de naafmoer goed vast
- Atornillar las tuercas laterales muy fuertes
- Apertar bem as porcas de cubo
- Stringere saldamente il dado del mozzo
- Затянуть гайки ступиц
- 拧紧

 90 mm 

- 6**  1x  1x  1x  2x  1x  1x



- 7**  1x  3x  2x  1x  30° 1x

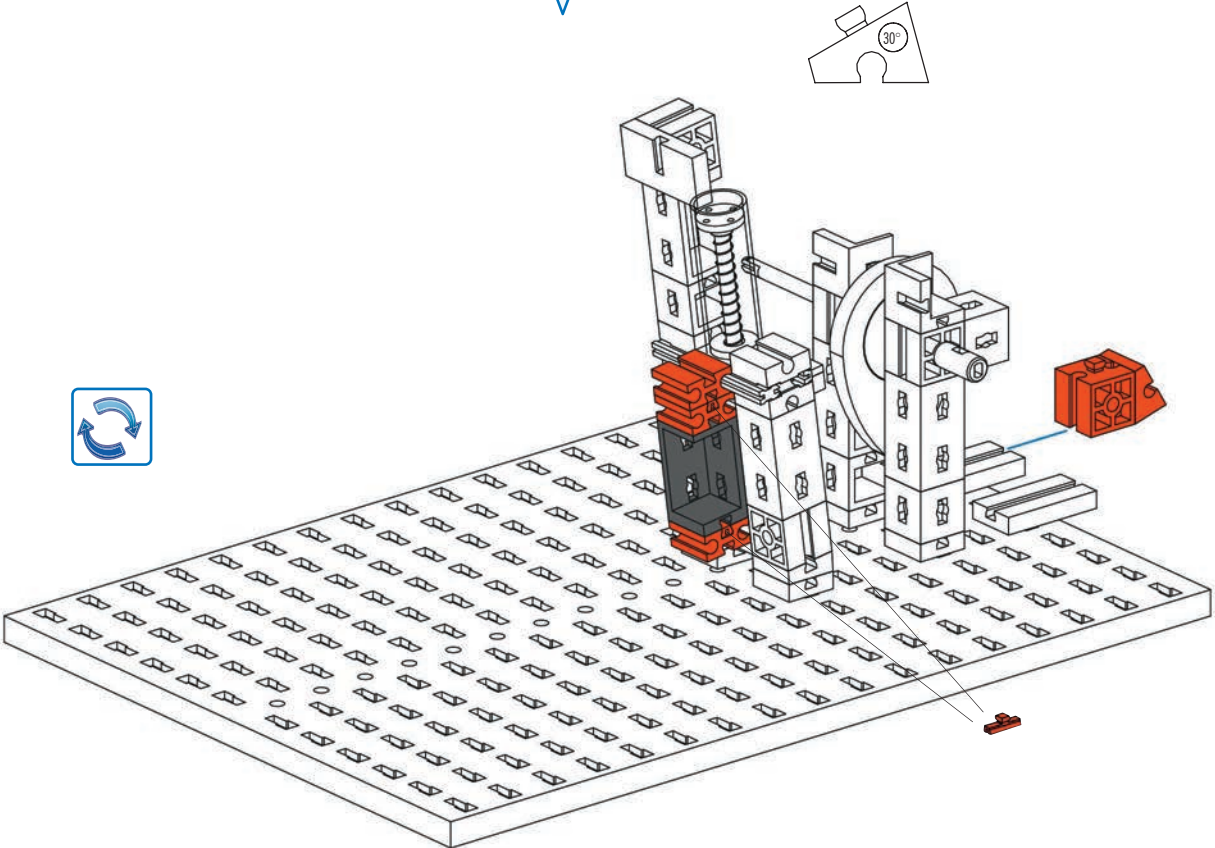

8

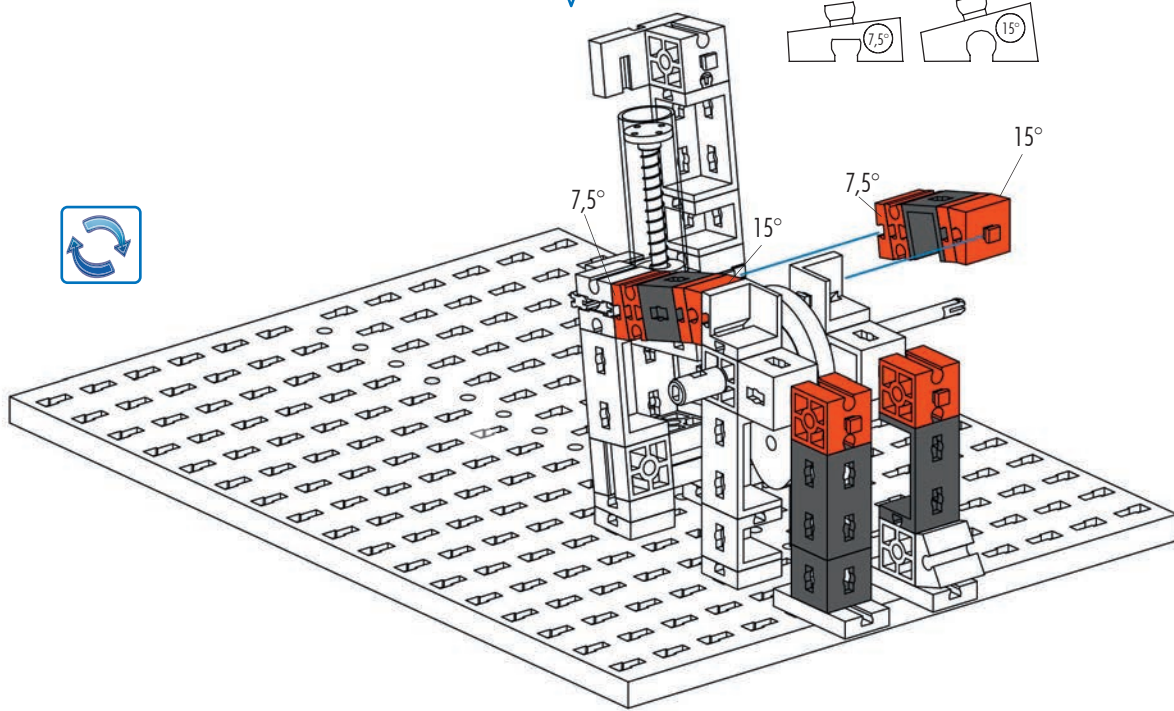
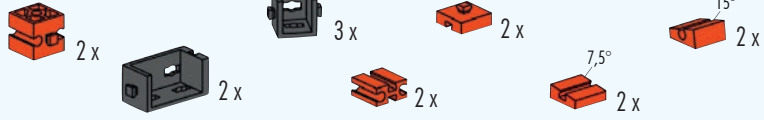

9

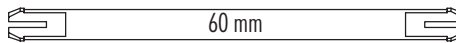
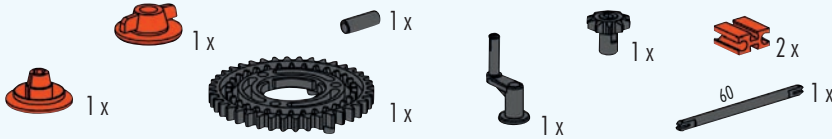

- Nabenmutter sehr fest anziehen
- Fasten the hub nut very tightly
- Serrer l'écrou du moyeu très serré
- Draai de naafmoer goed vast
- Atornillar las tuercas laterales muy fuertes
- Apertar bem as porcas de cubo
- Stringere saldamente il dado del mozzo
- Затянуть гайки ступиц
- 拧紧

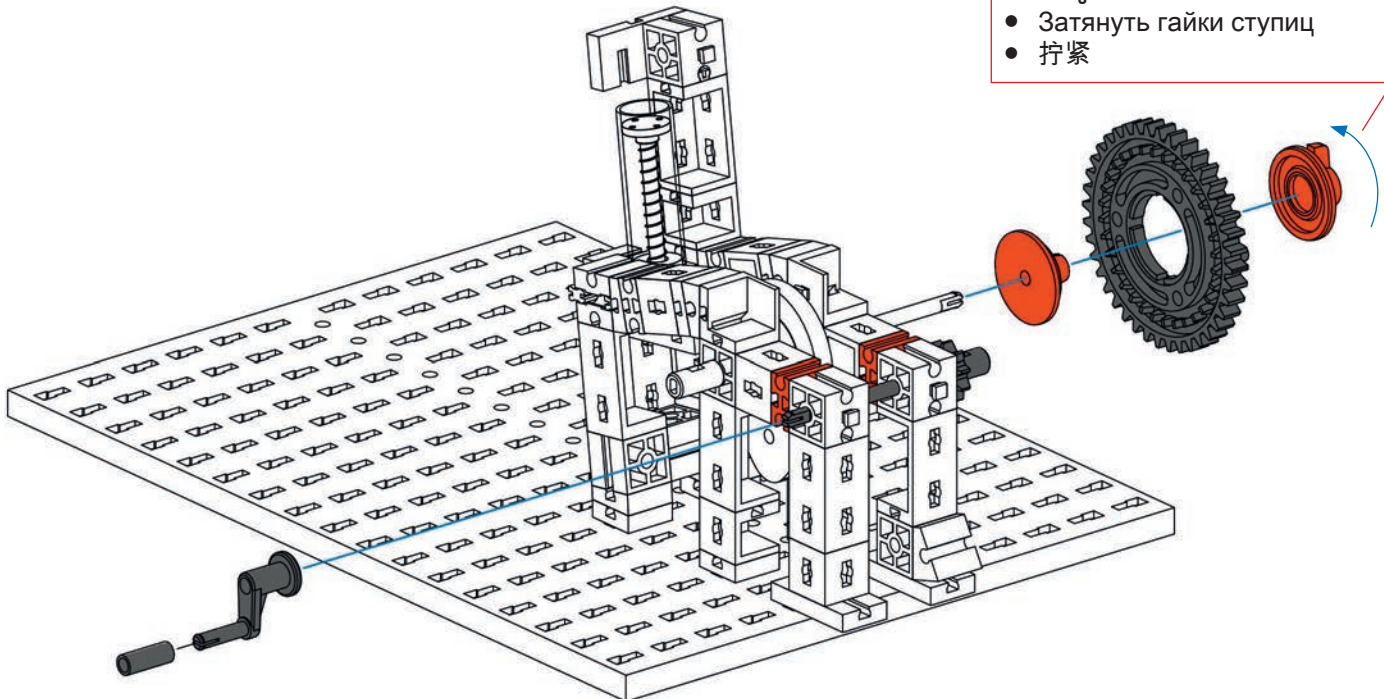

Parcours 3 S./p. 24

10



1x



4x



2x



2x



2x



1x

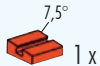

7.5°

1x



7.5°

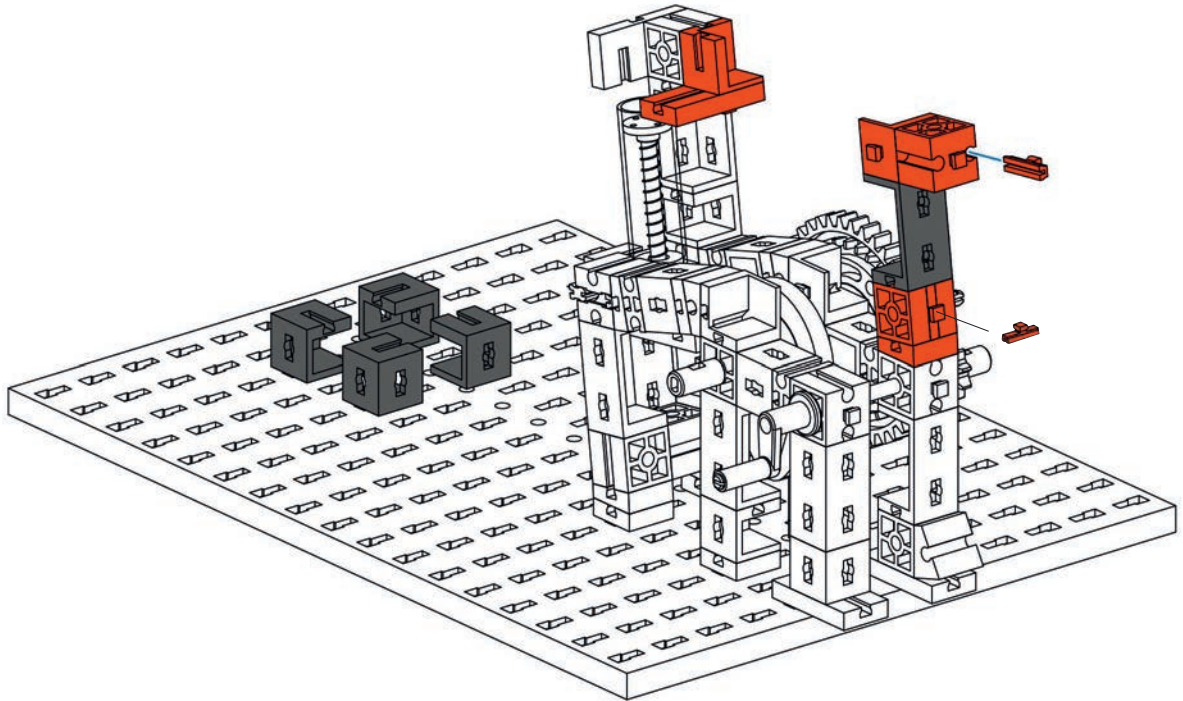

11

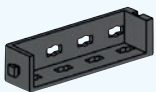

1x

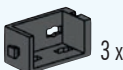

3x



1x



1x



2x



2x



1x



15°

2x

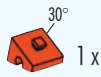

30°

1x



1x

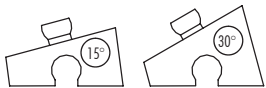

15°

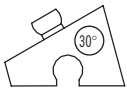

30°

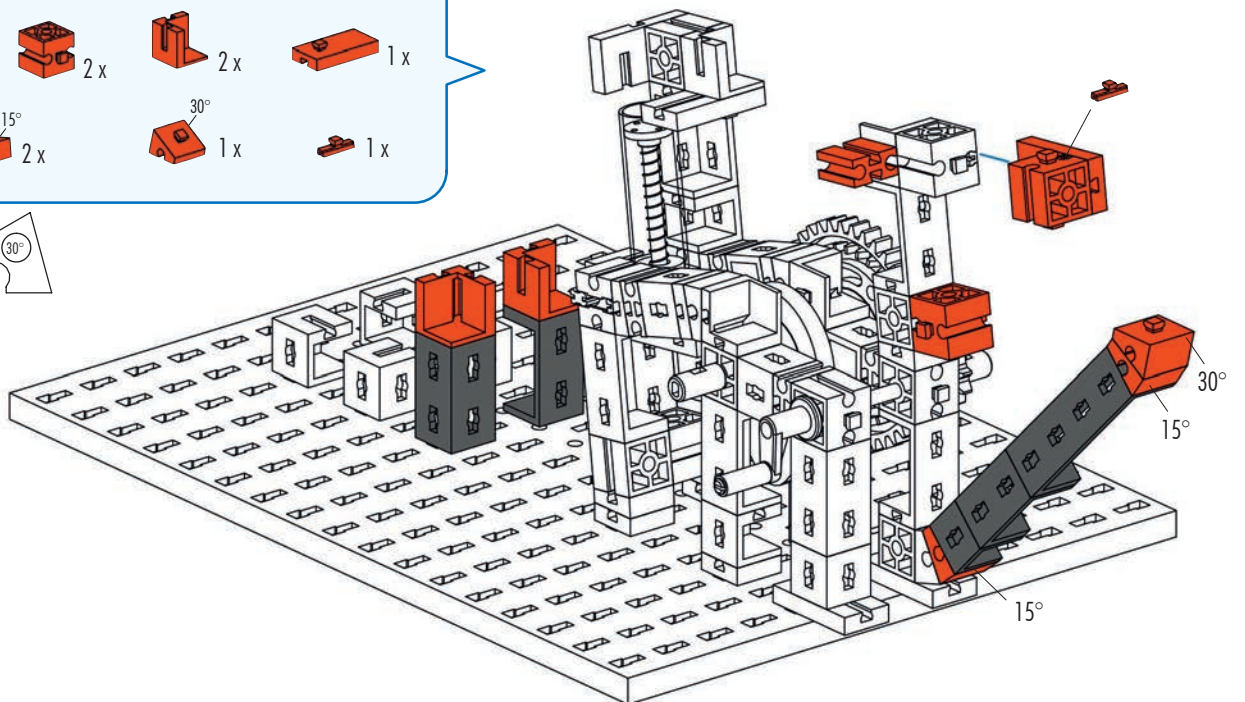

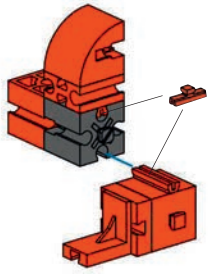

- 12**
- 1x (Grey 1x2 Technic Brick)
 - 1x (Orange 1x2 Technic Brick)
 - 2x (Orange 1x2 Technic Pin)
 - 1x (Orange 1x2 Technic Connector)
 - 1x (Orange 1x2 Technic Pin)
 - 1x (Orange 1x2 Technic Pin)
 - 1x (Orange 1x2 Technic Connector)
 - 1x (Orange 1x2 Technic Pin)

- 13**
- 1x (Orange 1x2 Technic Brick)
 - 1x (Orange 1x2 Technic Connector)
 - 1x (Orange 1x2 Technic Brick)
 - 2x (Orange 1x2 Technic Pin)
 - 1x (Black 15mm Technic Pin)
 - 2x (Black 1x2 Technic Pin)
- 75 mm

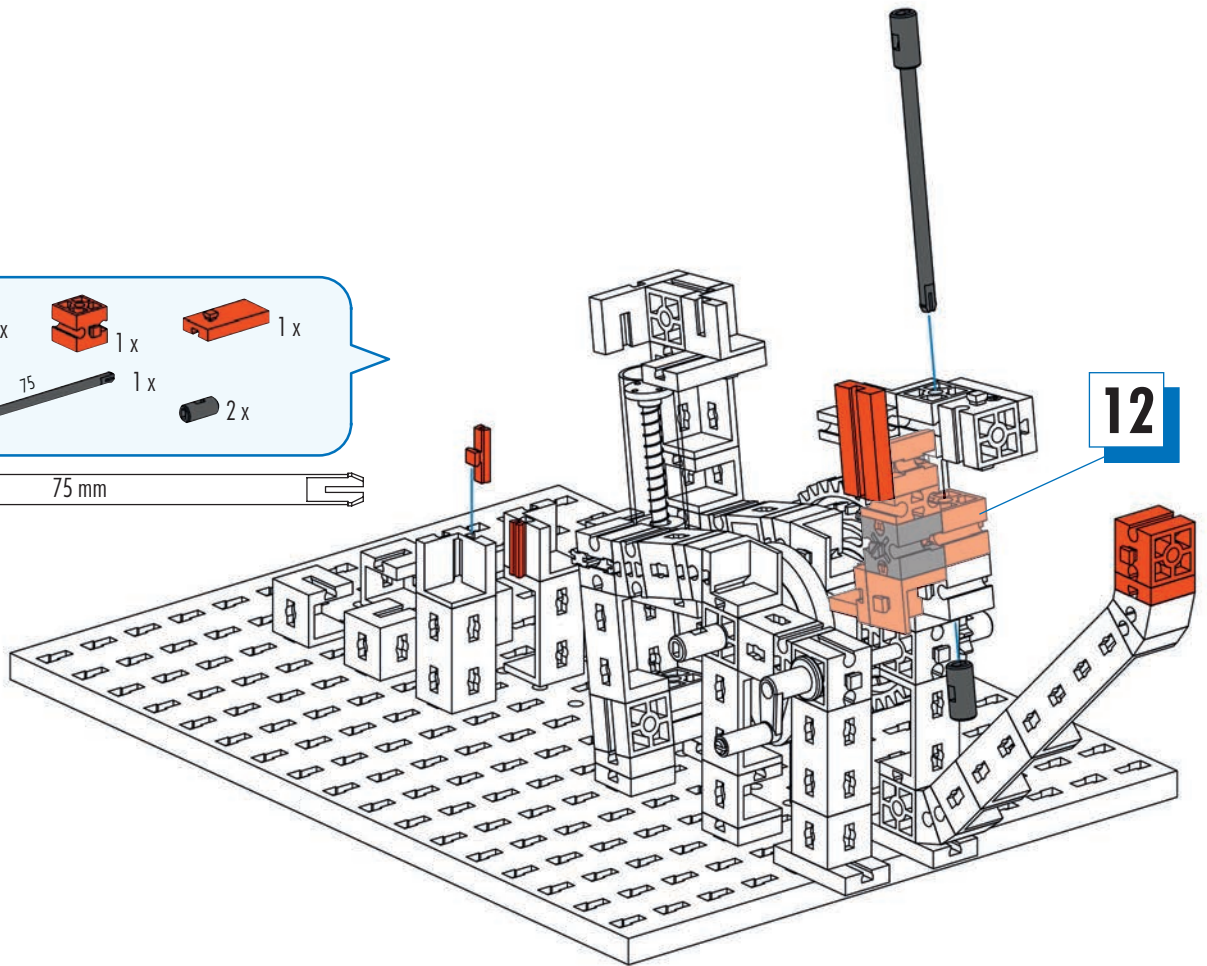

- 14**
- 1x (Green 1x2 Technic Connector)
 - 2x (Orange 1x2 Technic Pin)

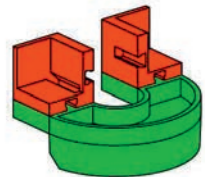

15

- 1 x Green Technic Beam 11
- 2 x Orange Technic Pin
- 2 x Orange Technic Pin
- 1 x Orange Technic Pin 30
- 2 x Orange Technic Pin

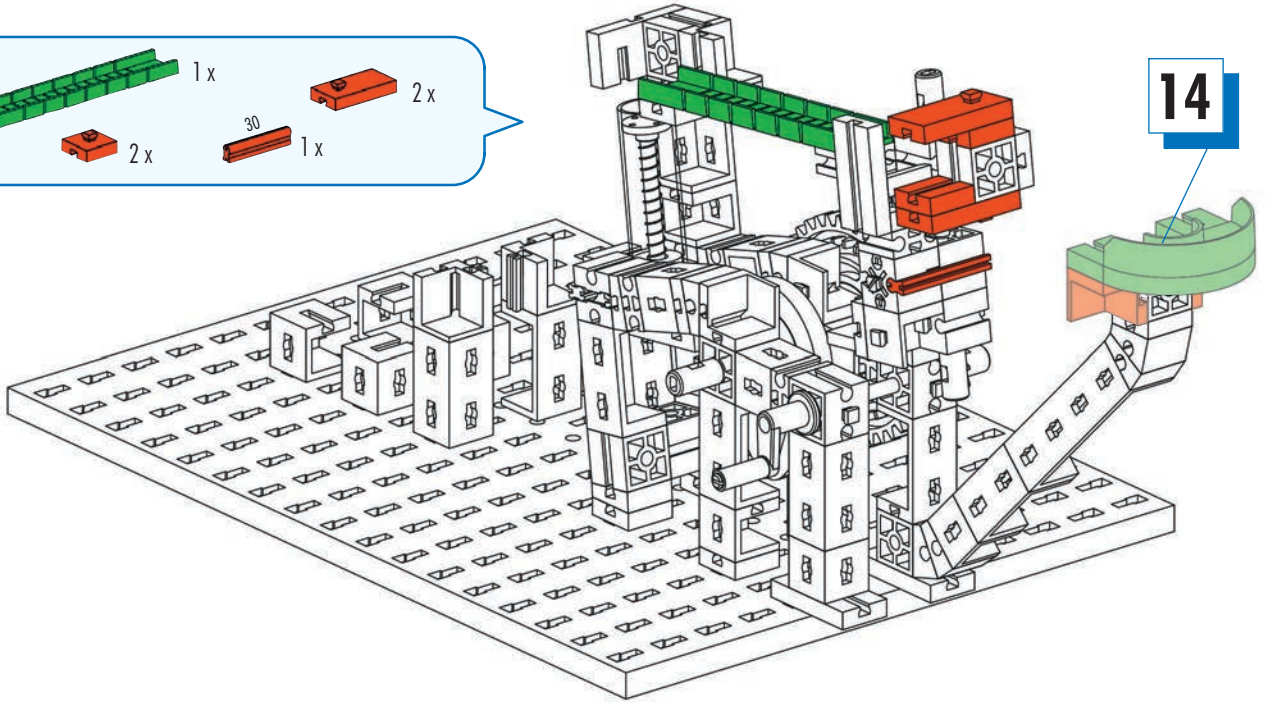

16

- 1 x Black Technic Axle 180
- 1 x Black Technic Pin
- 3 x Orange Technic Pin
- 1 x Orange Technic Pin
- 1 x Orange Technic Pin
- 1 x Orange Technic Pin
- 1 x Orange Technic Pin
- 1 x Orange Technic Pin
- 1 x Orange Technic Pin

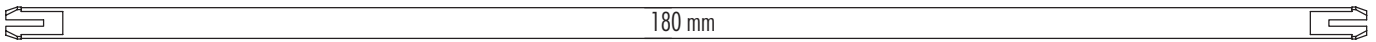
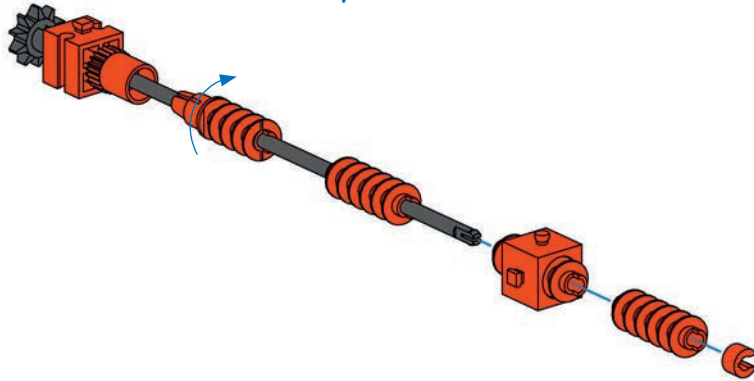

17

- 1 x Orange Technic Pin
- 1 x Orange Technic Pin
- 2 x Orange Technic Pin
- 1 x Black Technic Pin
- 4 x Orange Technic Pin

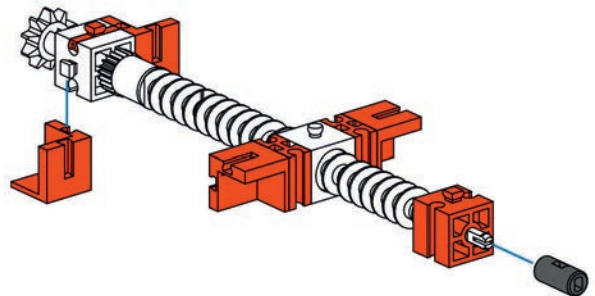

18

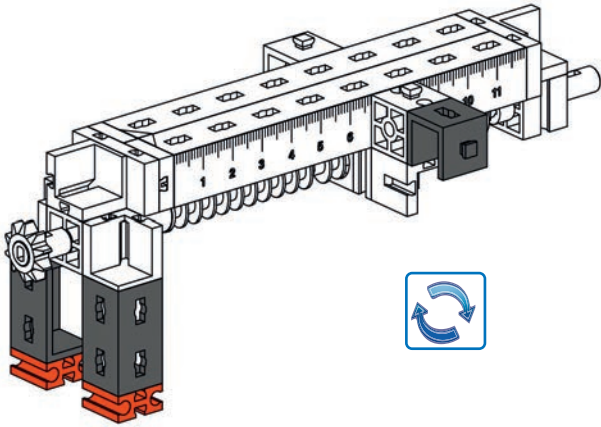
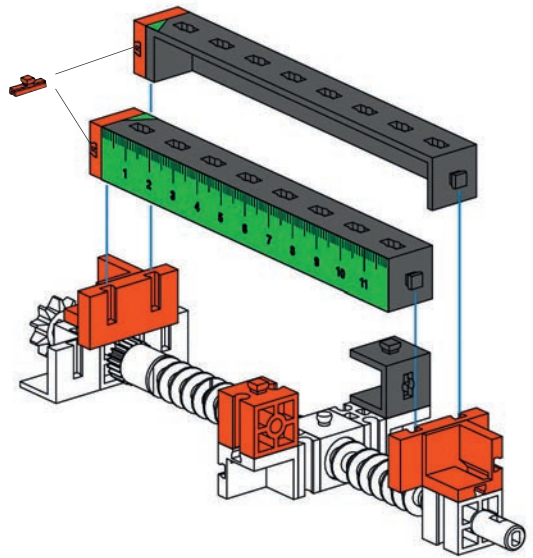
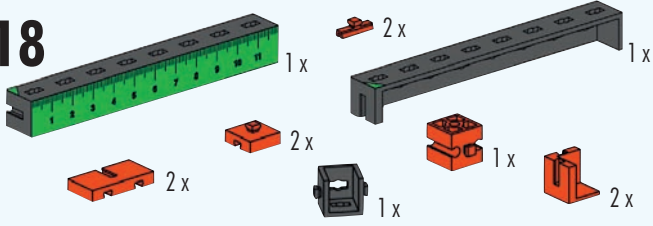

19



20

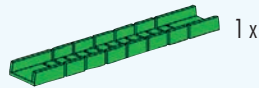

19

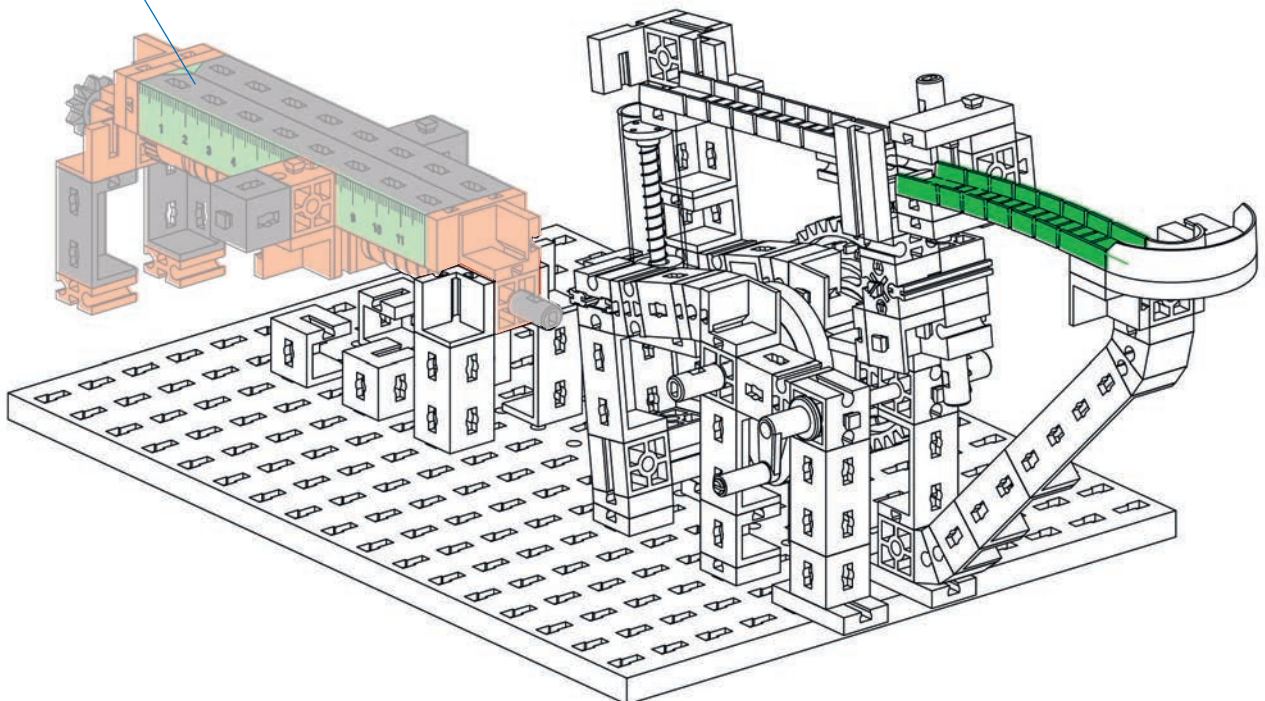

21

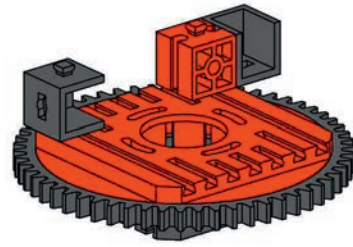
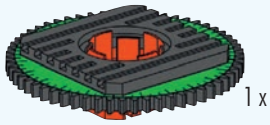

21

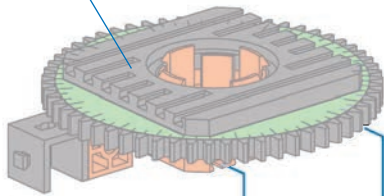

22

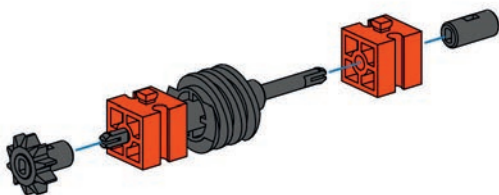
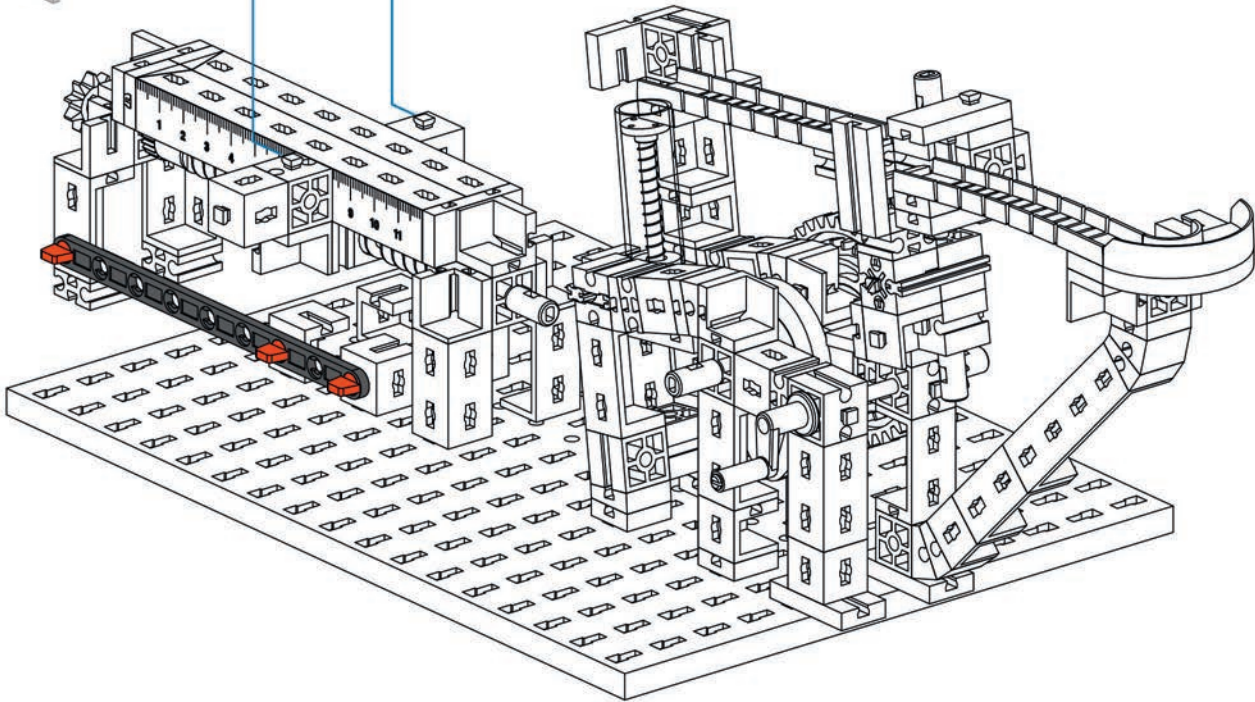

23





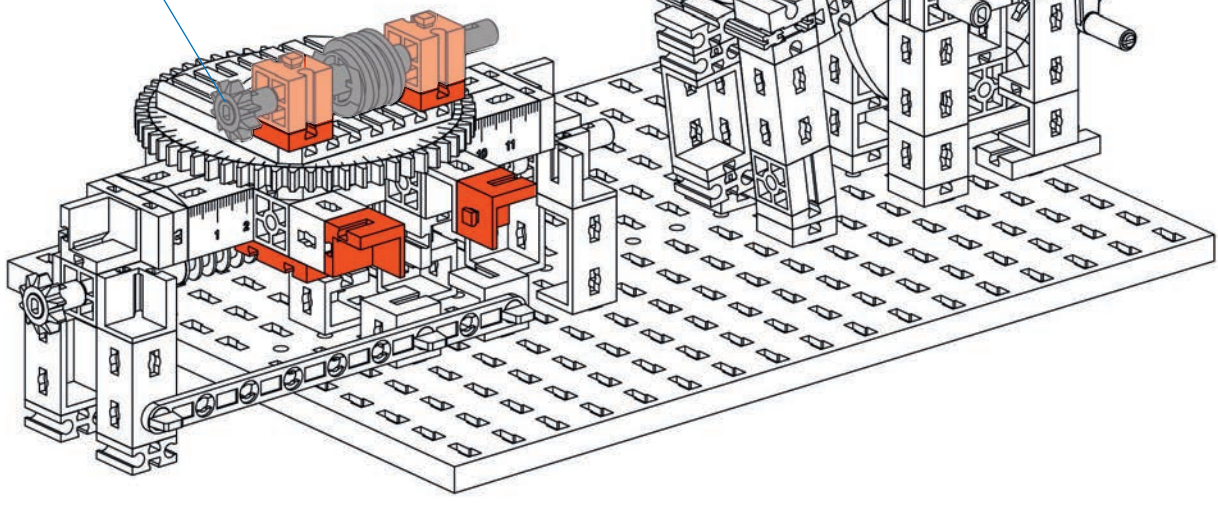

24

-  1x
-  2x
-  2x

23







25

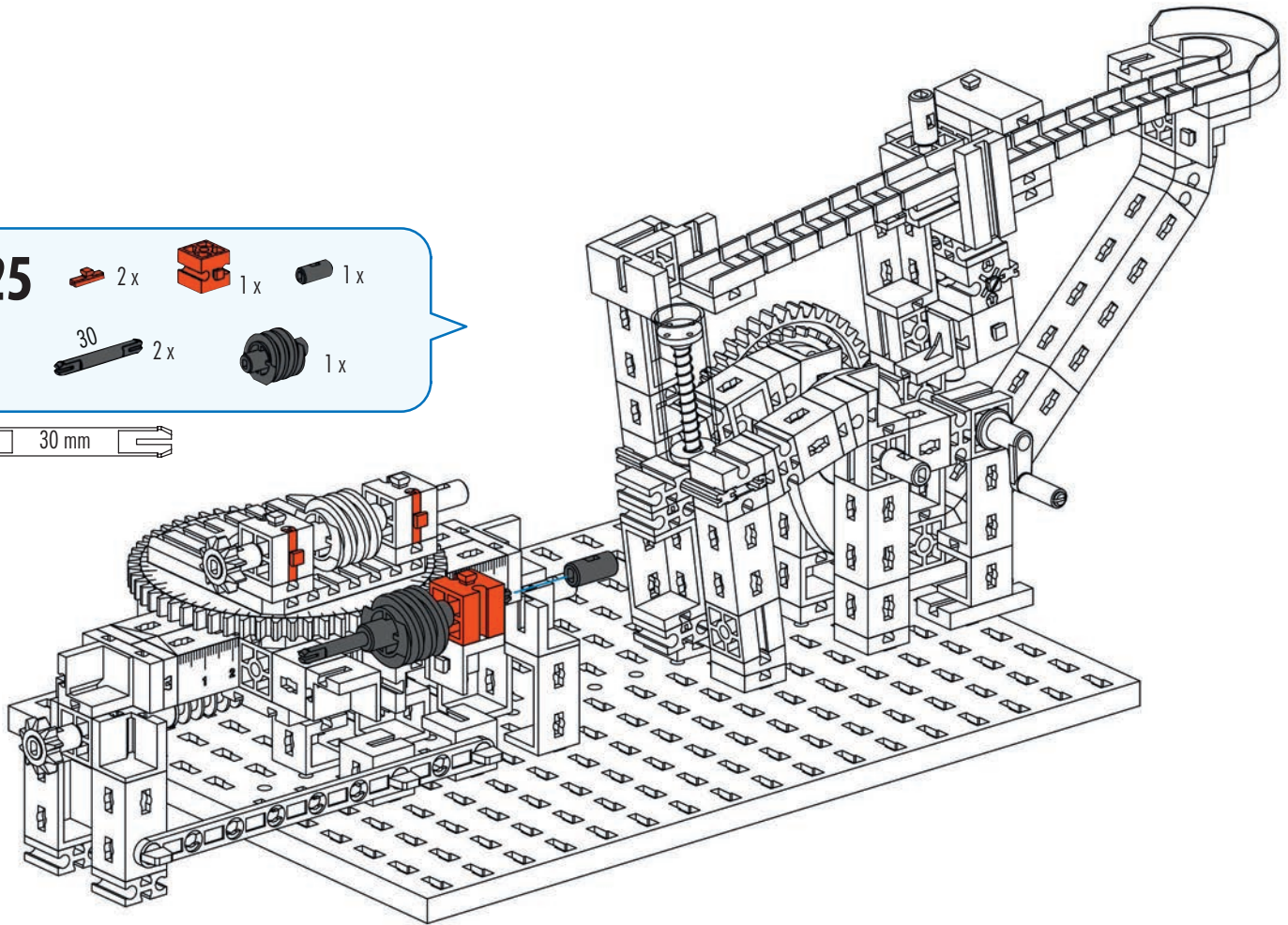



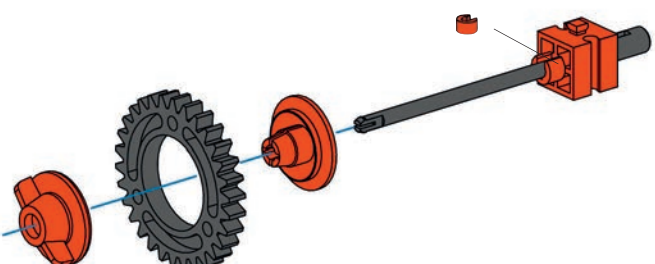
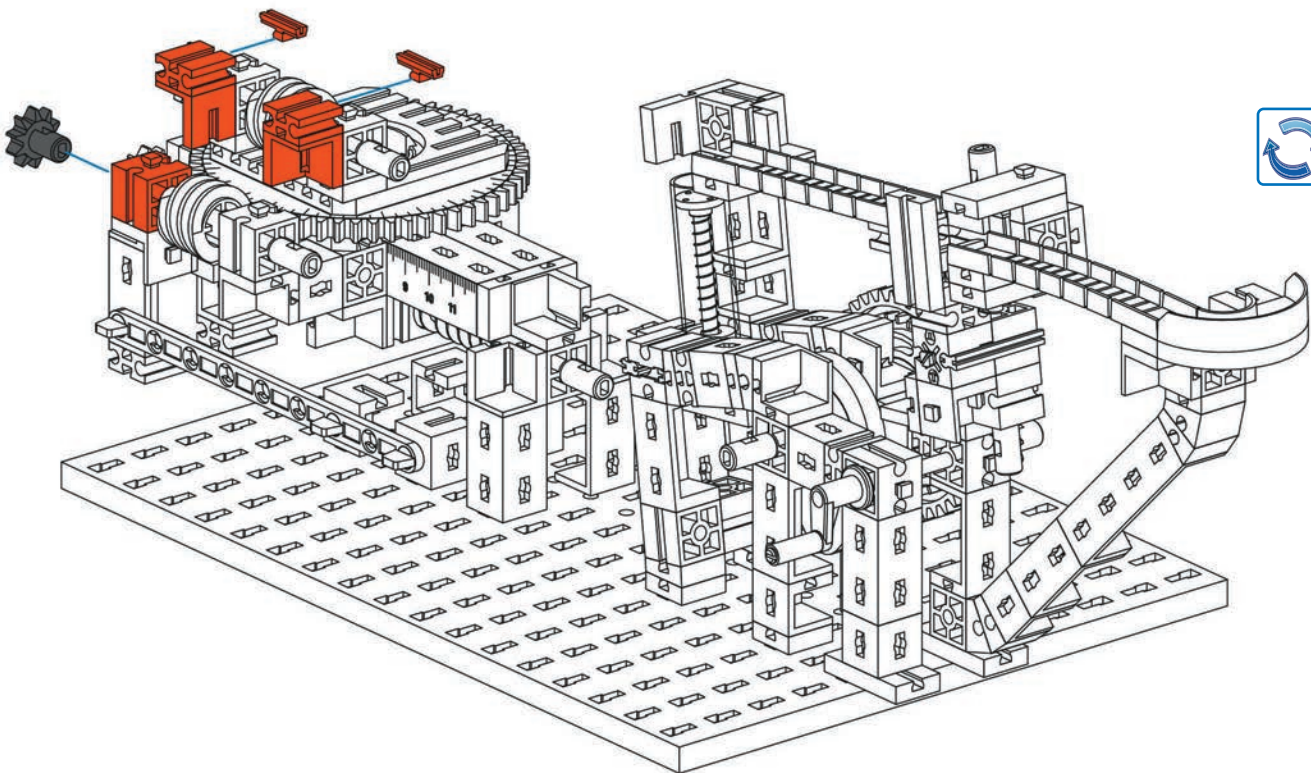

-  2x
-  1x
-  1x
-  2x
-  1x

30 mm

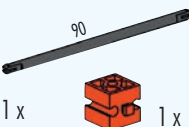

26  2x  2x  1x  1x  2x



27  1x  90 1x  1x  1x  1x  1x  1x

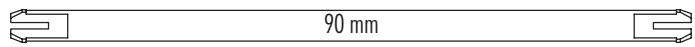

28

- 1x [Red 1x2 Technic Brick with Hole]
- 2x [Red 1x3 Technic Brick]
- 1x [Red 1x2 Technic Brick with Hole]
- 1x [Red 1x2 Technic Pin]
- 1x [Red 1x2 Technic Pin]
- 2x [Red 1x2 Technic Pin]
- 1x [Red 1x2 Technic Pin]

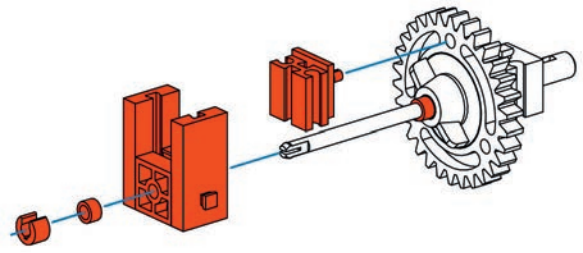

29

- 2x [Red 1x3 Technic Brick]
- 1x [Red 1x2 Technic Brick with Hole]
- 1x [Red 1x2 Technic Brick]
- 1x [Red 1x2 Technic Brick]
- 1x [Grey 1x2 Technic Brick]
- 1x [Red 1x2 Technic Pin]
- 1x [Grey 1x2 Technic Pin]

28

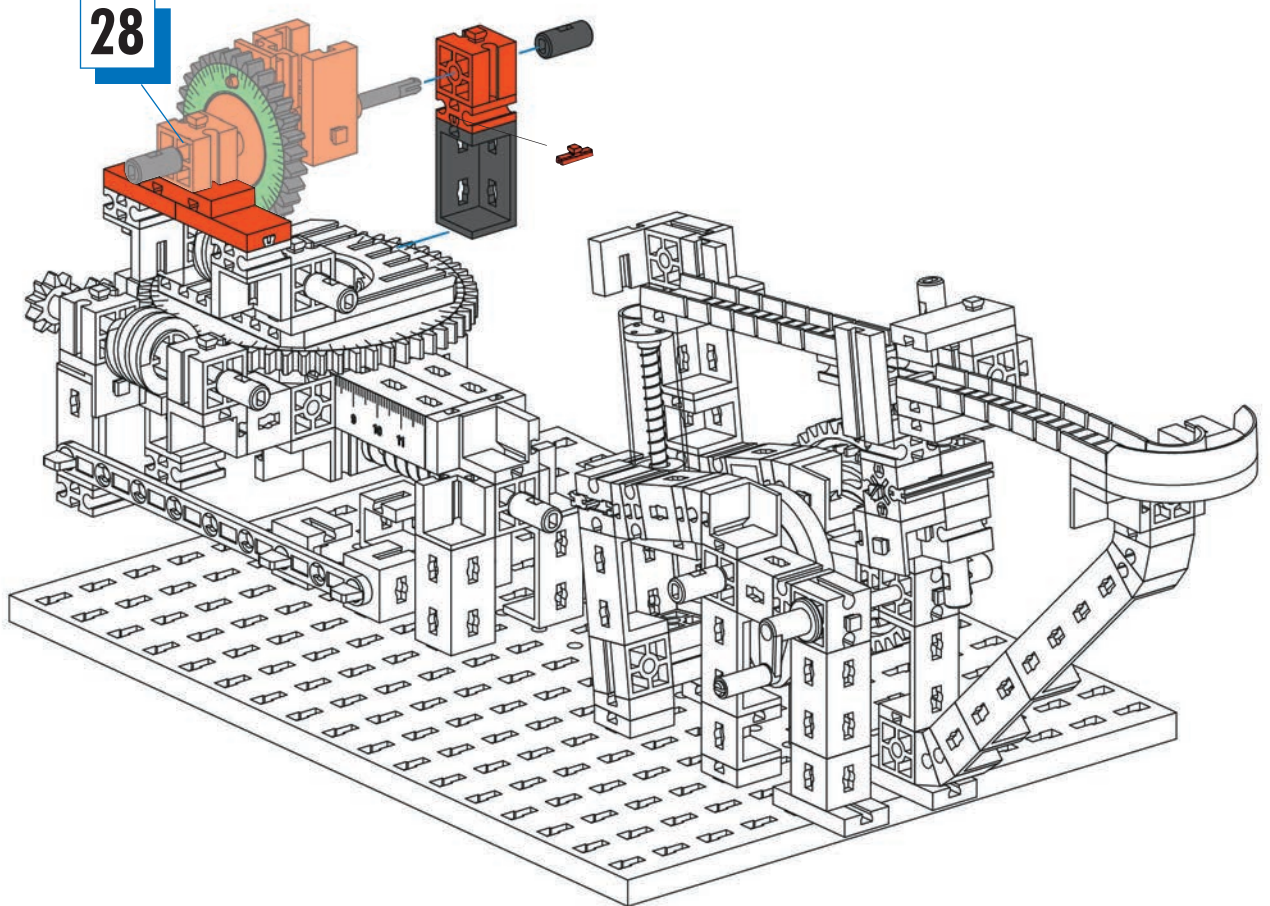

30

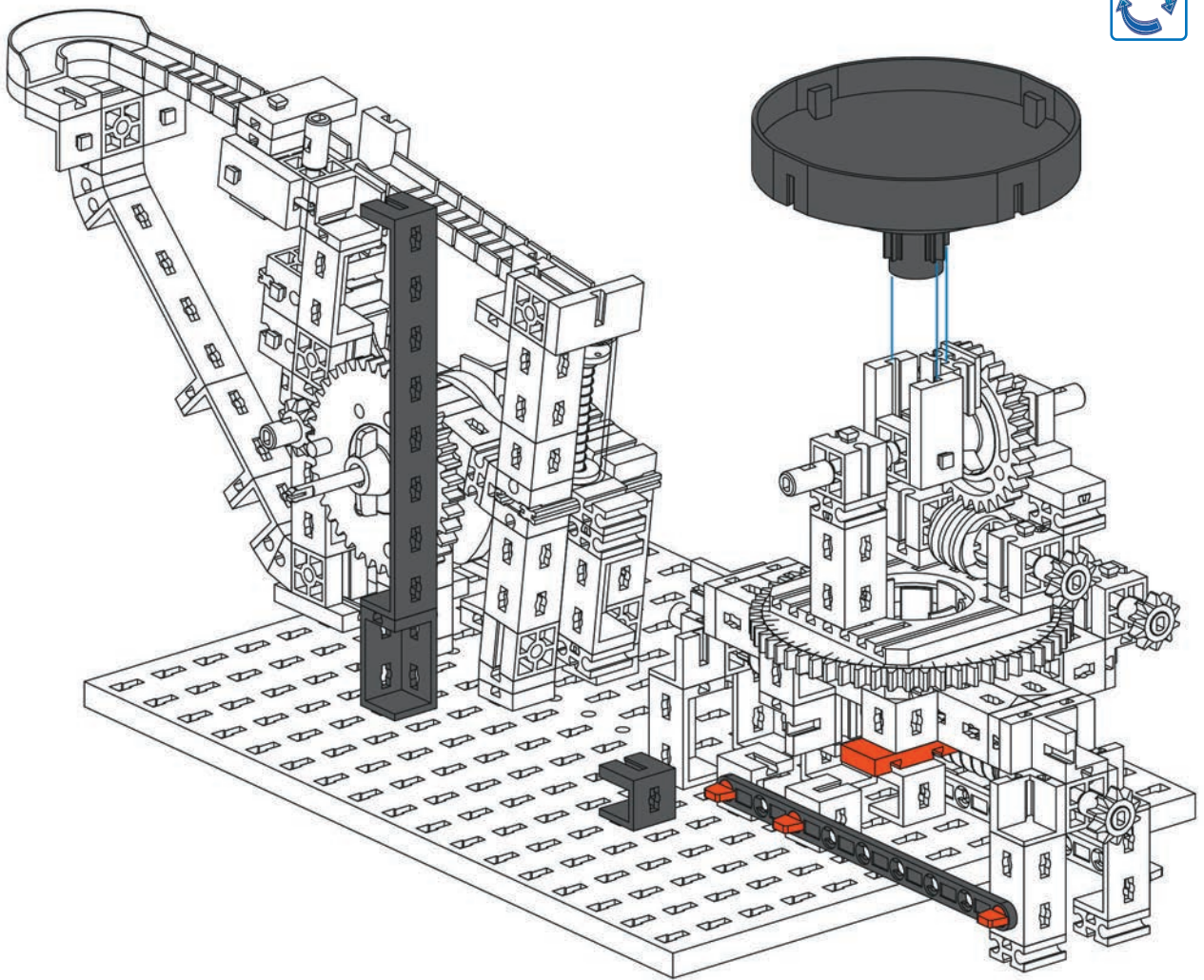
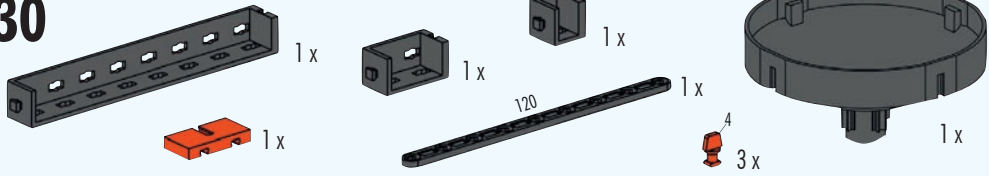



31

 2x

169,6

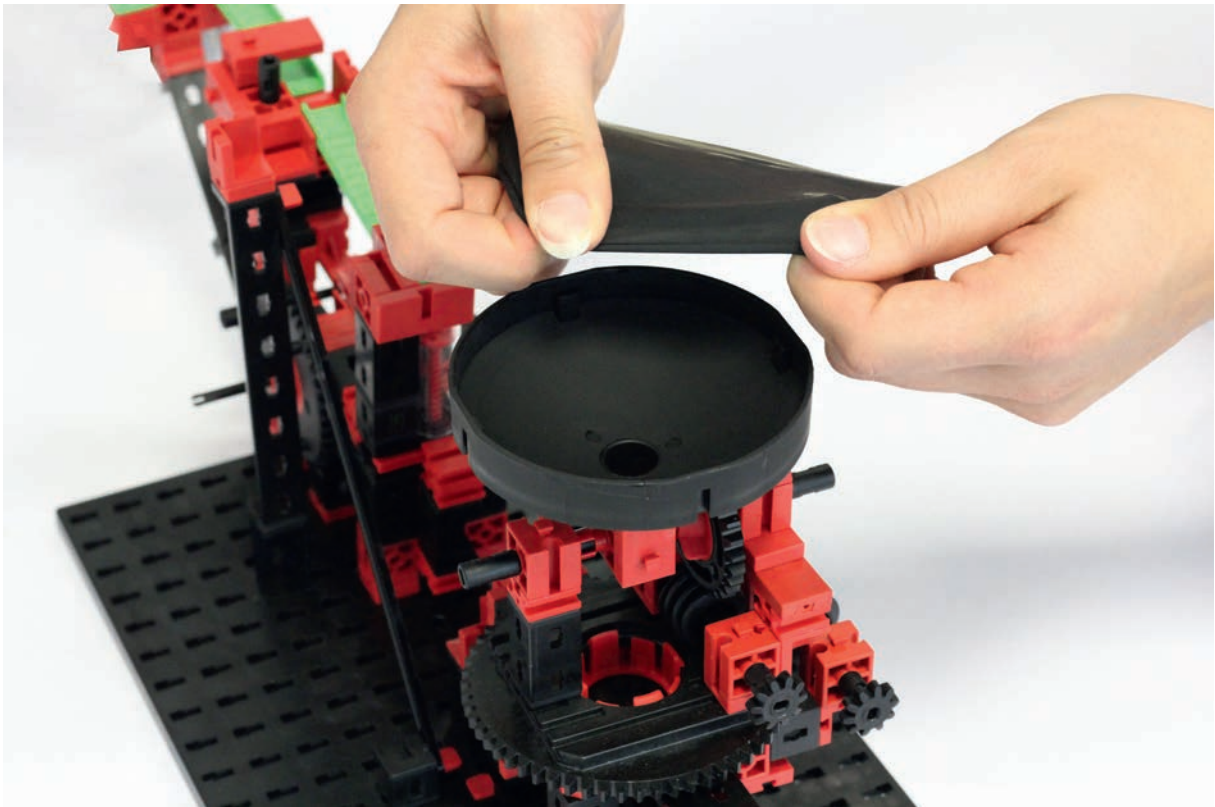
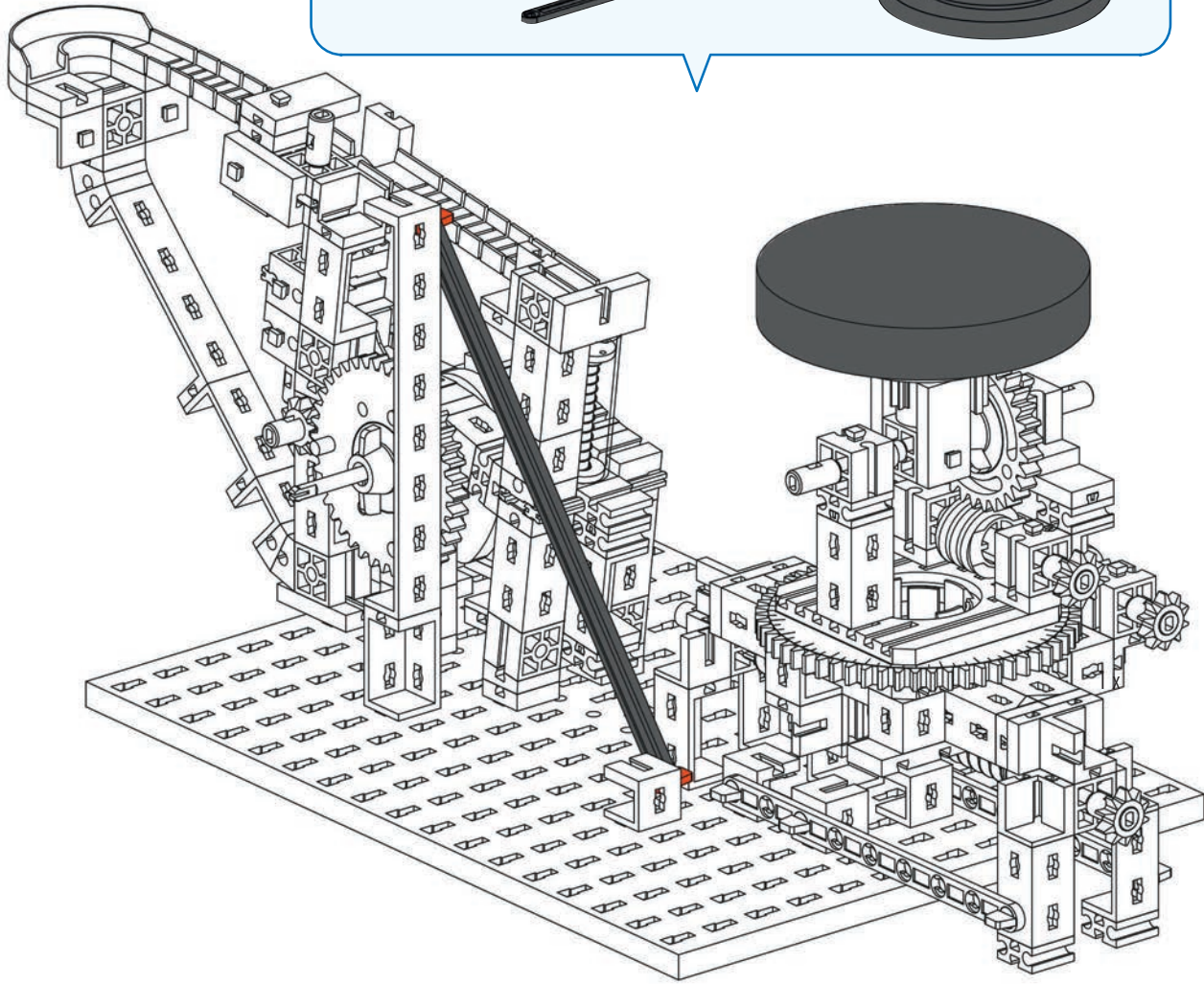
1x



Parcours 2  S./p. 22

32

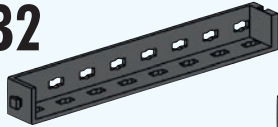

1 x



1 x



1 x



1 x







2 x

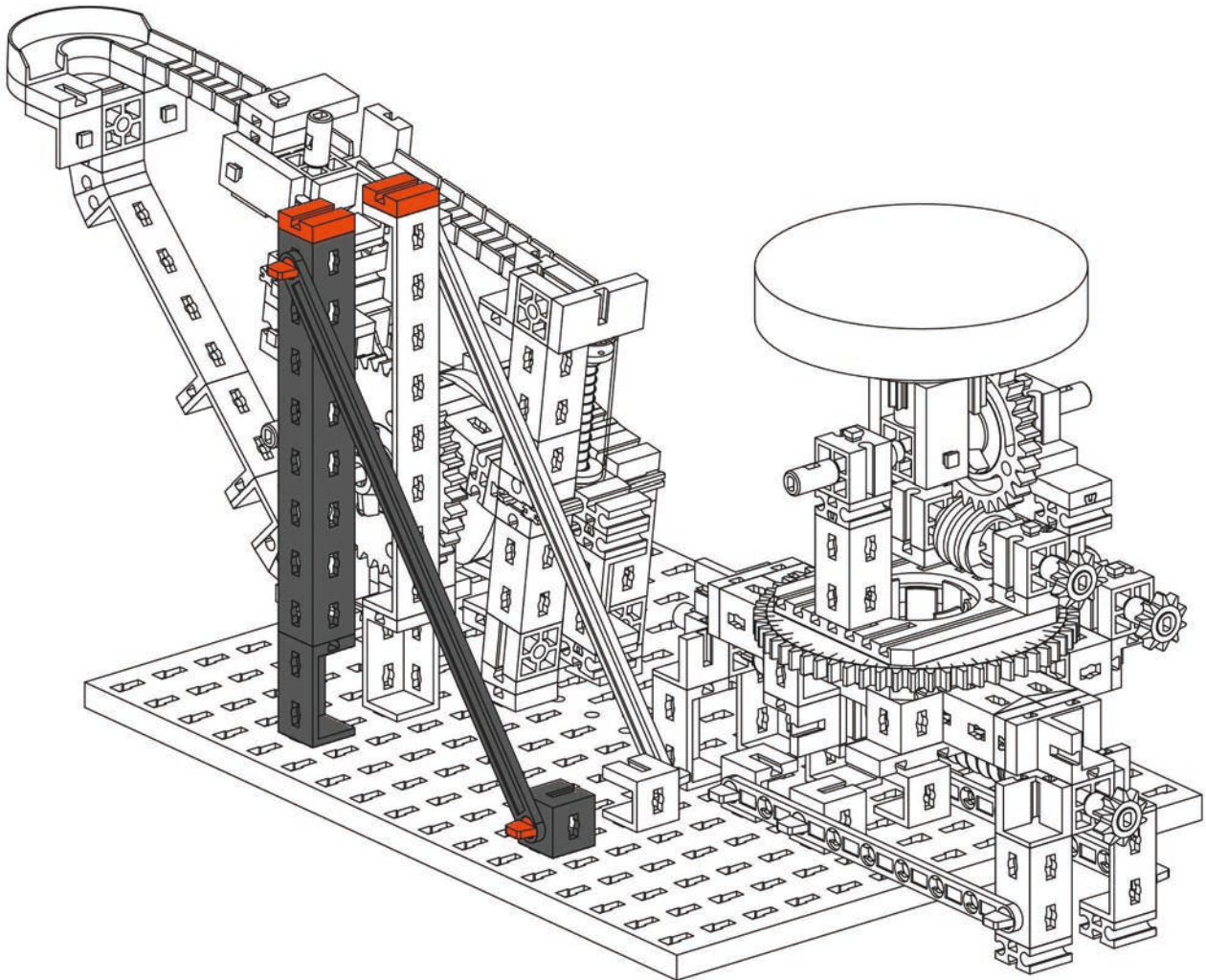

2 x

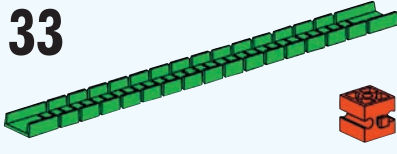



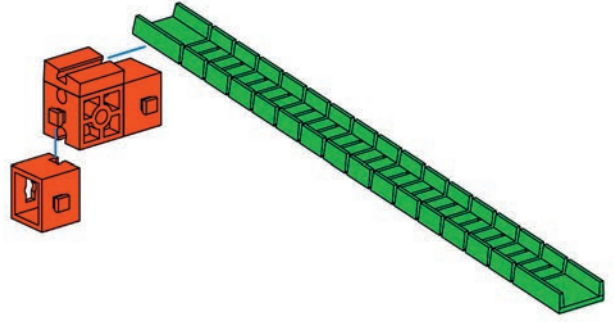

33

- 1 x 
- 1 x 
- 1 x 
- 2 x 

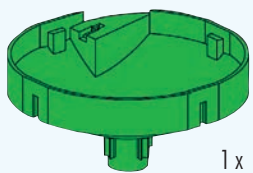

34

- 1 x 
- 2 x 
- 1 x 
- 2 x 

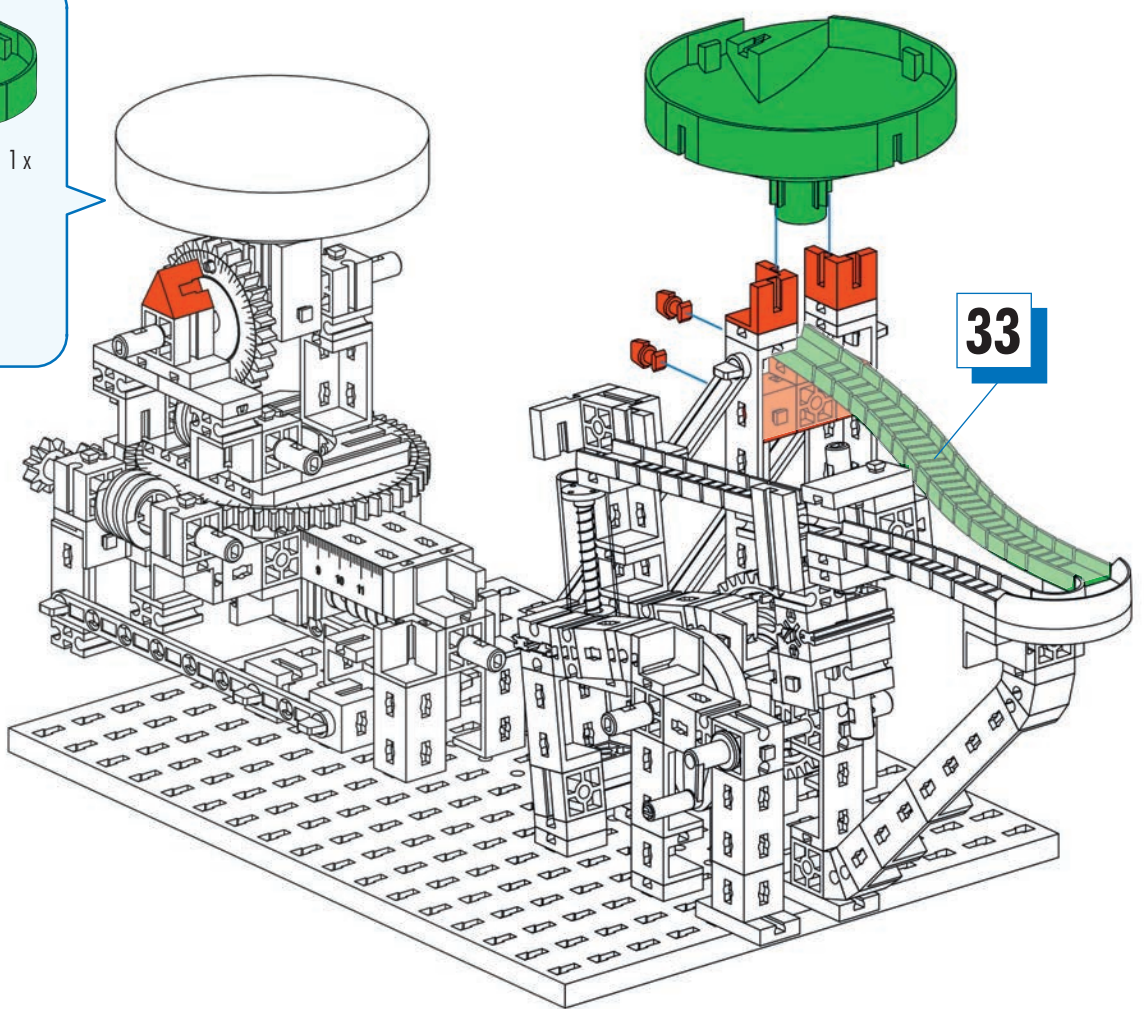

33

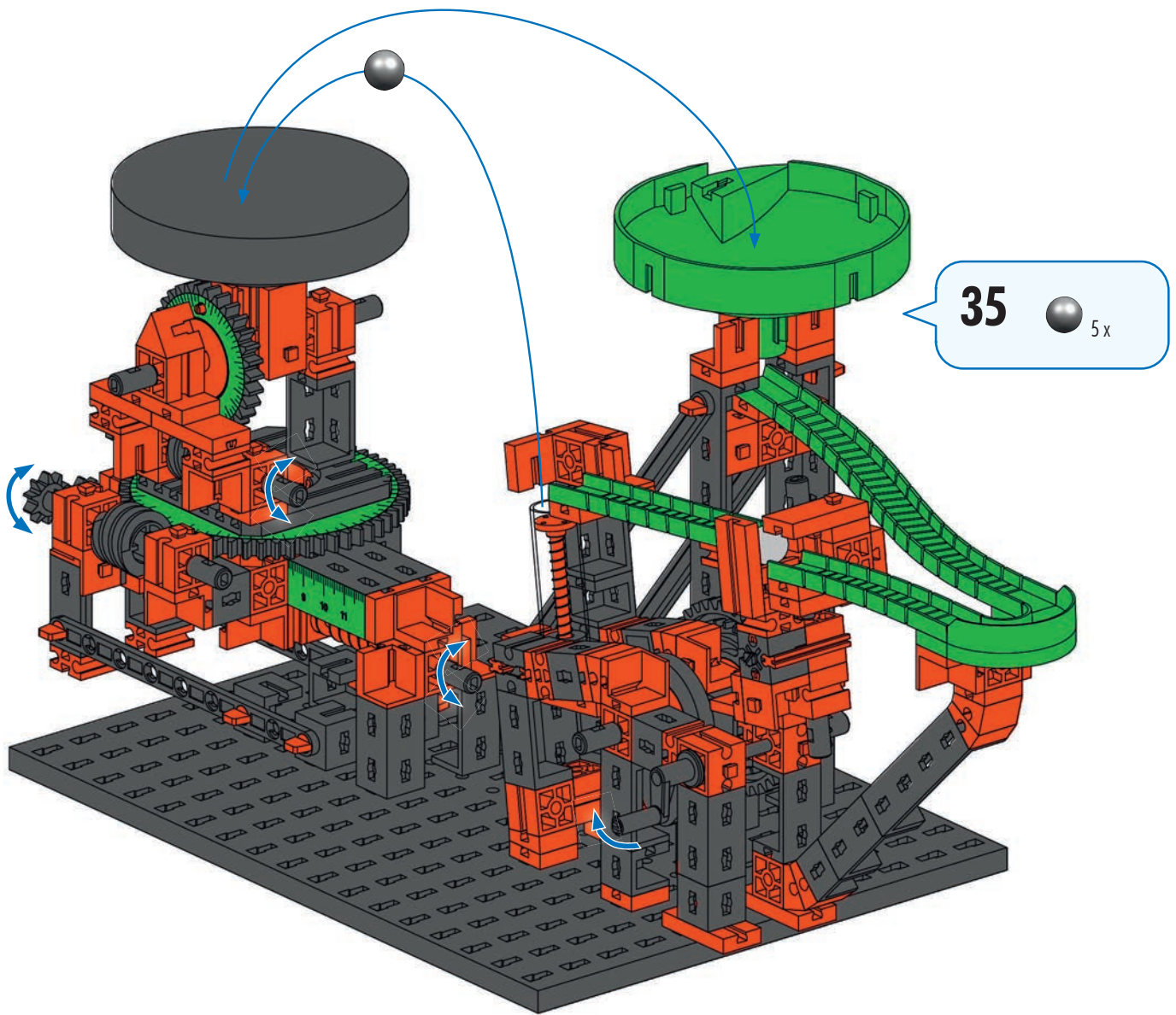

Weitere Modellideen unter www.fischertechnik.de/downloads/dynamic
 More model ideas at www.fischertechnik.de/downloads/dynamic
 Autres idées de modèles sous www.fischertechnik.de/downloads/dynamic
 Meer modelideeën op www.fischertechnik.de/downloads/dynamic
 Más ideas de modelos en www.fischertechnik.de/downloads/dynamic
 Mais ideias de modelos em www.fischertechnik.de/downloads/dynamic
 Per altri modelli e idee si rimanda al sito www.fischertechnik.de/downloads/dynamic
 Другие идеи моделей см. www.fischertechnik.de/downloads/dynamic
 电机其它的模型设想可访问网页 www.fischertechnik.de/downloads/dynamic

Motorisierung
Motorization
Motorisation

Motorisering
Motorización
Motorização

Motorizzazione
Приводной механизм
电动卷扬机 机动化与遥控

Motor Set XS
505 281

1

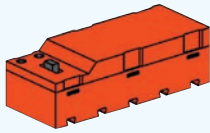

1x



4x

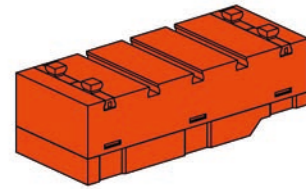

2



1x



1x



1x



1x



1x



1x

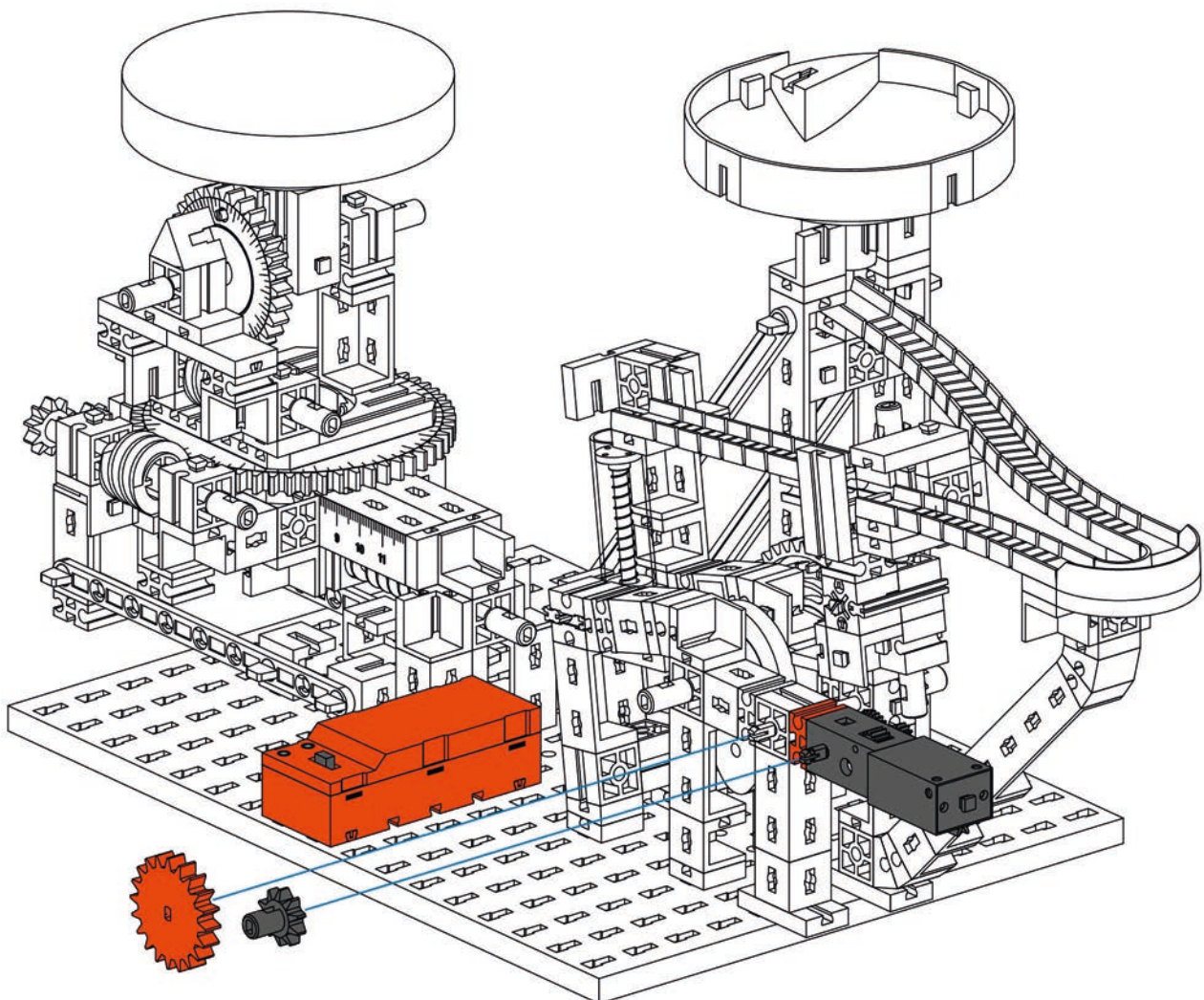

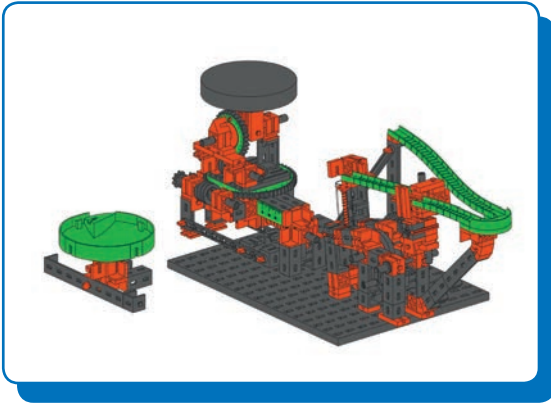

Parcours 2
Obstacle course 2
Parcours 2

Parcours 2
Pista de recorrido 2
Circuito 2

Circuito 2
Маршрут 2
滚珠赛道 2

1-31

Parcours 1
Obstacle course 1
Parcours 1

Parcours 1
Pista de recorrido 1
Circuito 1

Circuito 1
Маршрут 1
滚珠赛道 1

Seite 4
Page 4
Page 4
Bladzijde 4
Página 4
Pagina 4
Página 4
Страница 4
页次 4

32

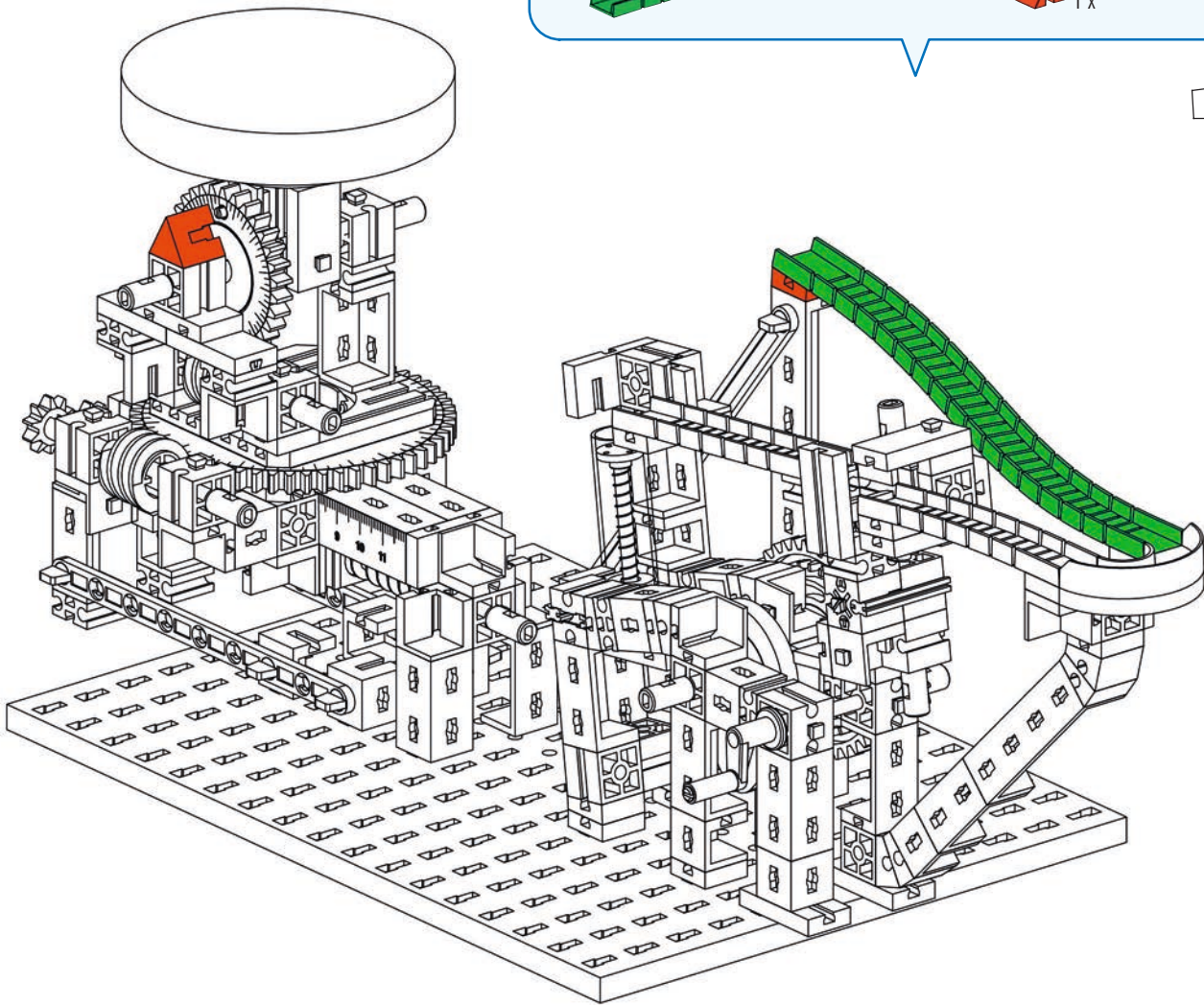
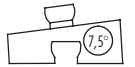
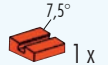
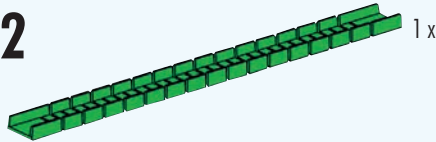

33

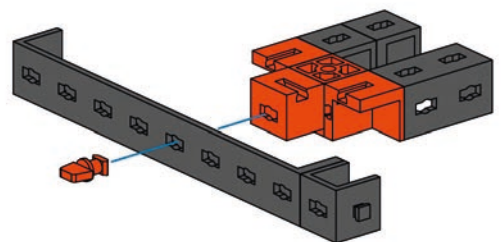
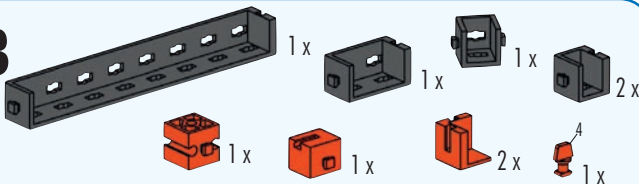

34

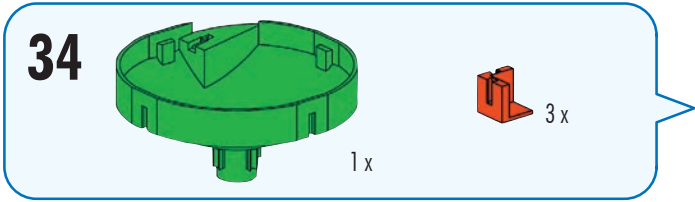

1x

3x

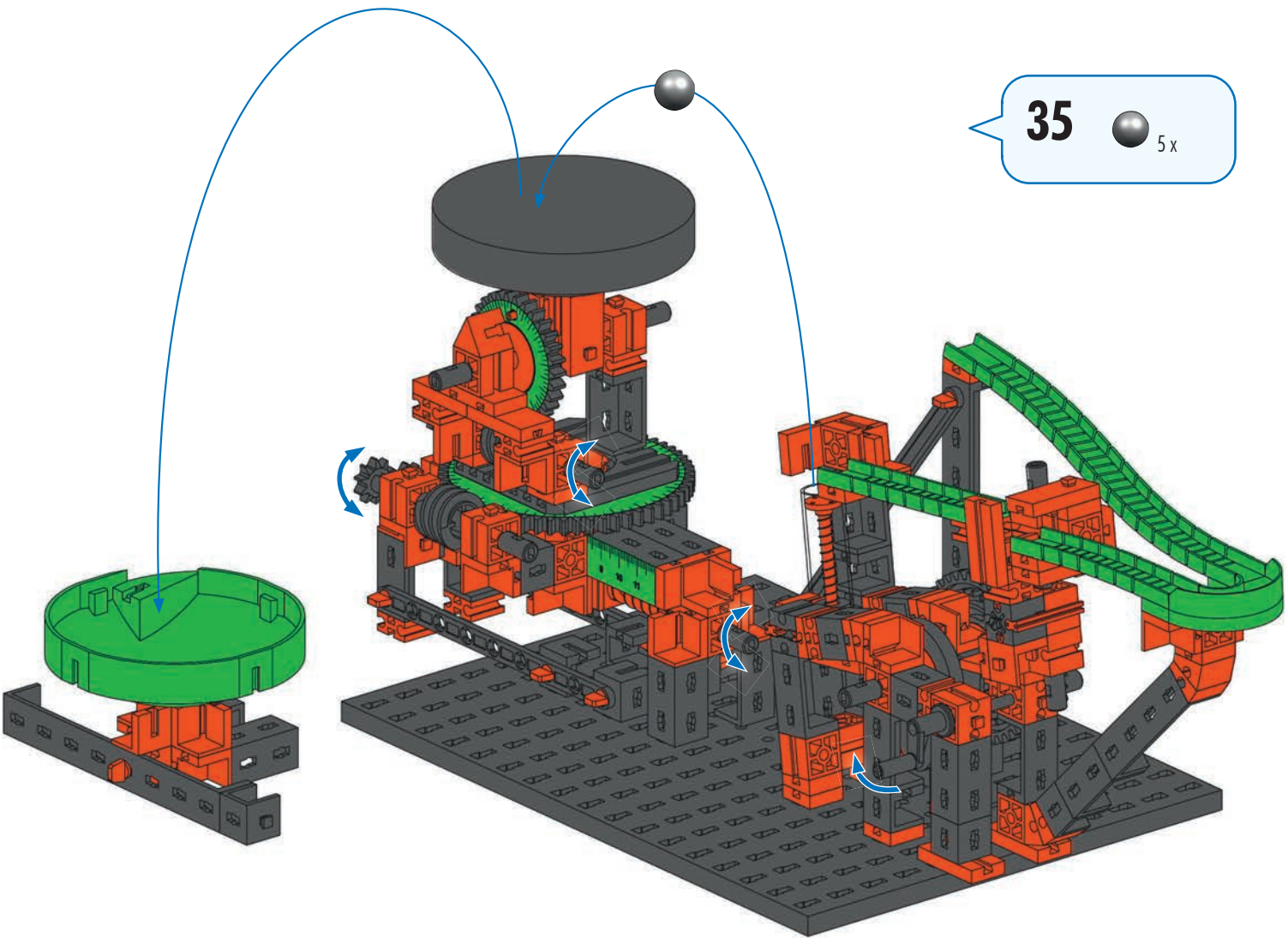
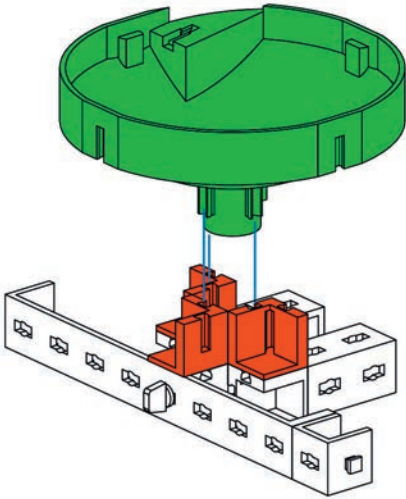

35



5x

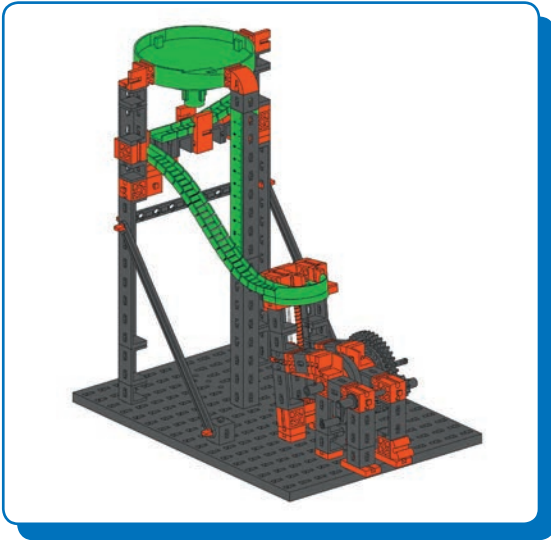

Parcours 3
Obstacle course 3
Parcours 3

Parcours 3
Pista de recorrido 3
Circuito 3

Circuito 3
Маршрут 3
滚珠弯道 3

1-9

Parcours 1
 Obstacle course 1
 Parcours 1

Parcours 1
 Pista de recorrido 1
 Circuito 1

Circuito 1
 Маршрут 1
 滚珠弯道 1

Seite 4
 Page 4
 Page 4
 Bladzijde 4
 Página 4
 Pagina 4
 Pagina 4
 Страница 4
 页次 4

10

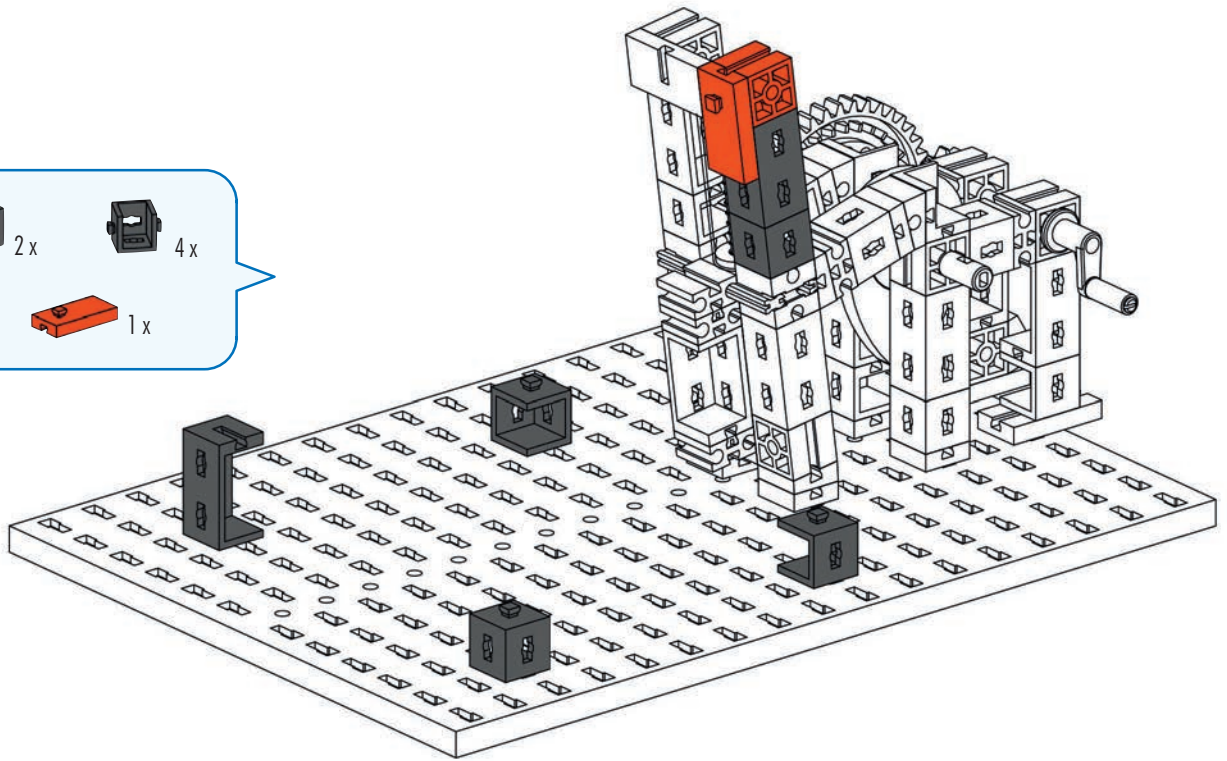

11

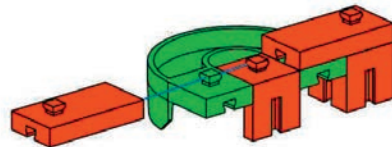

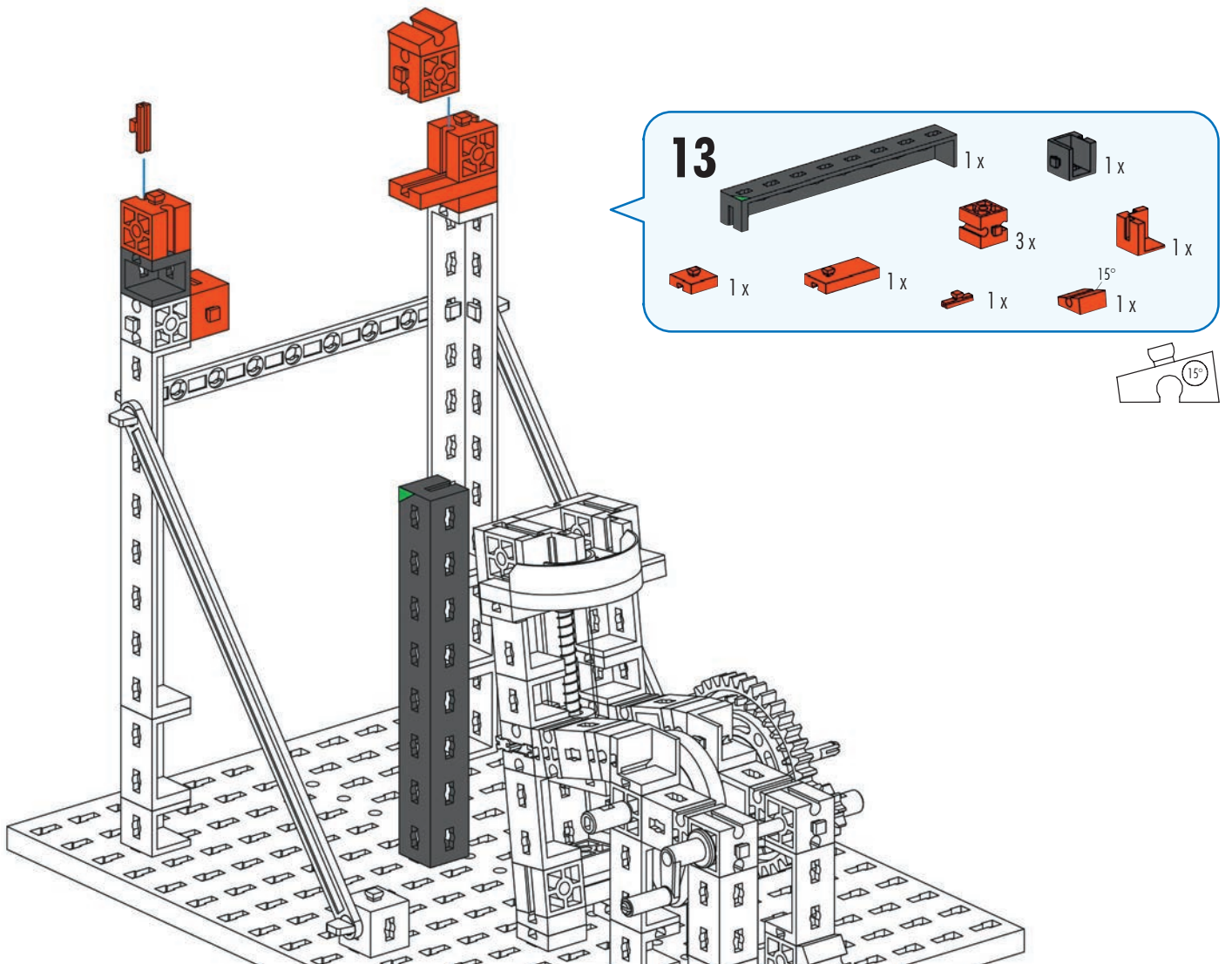
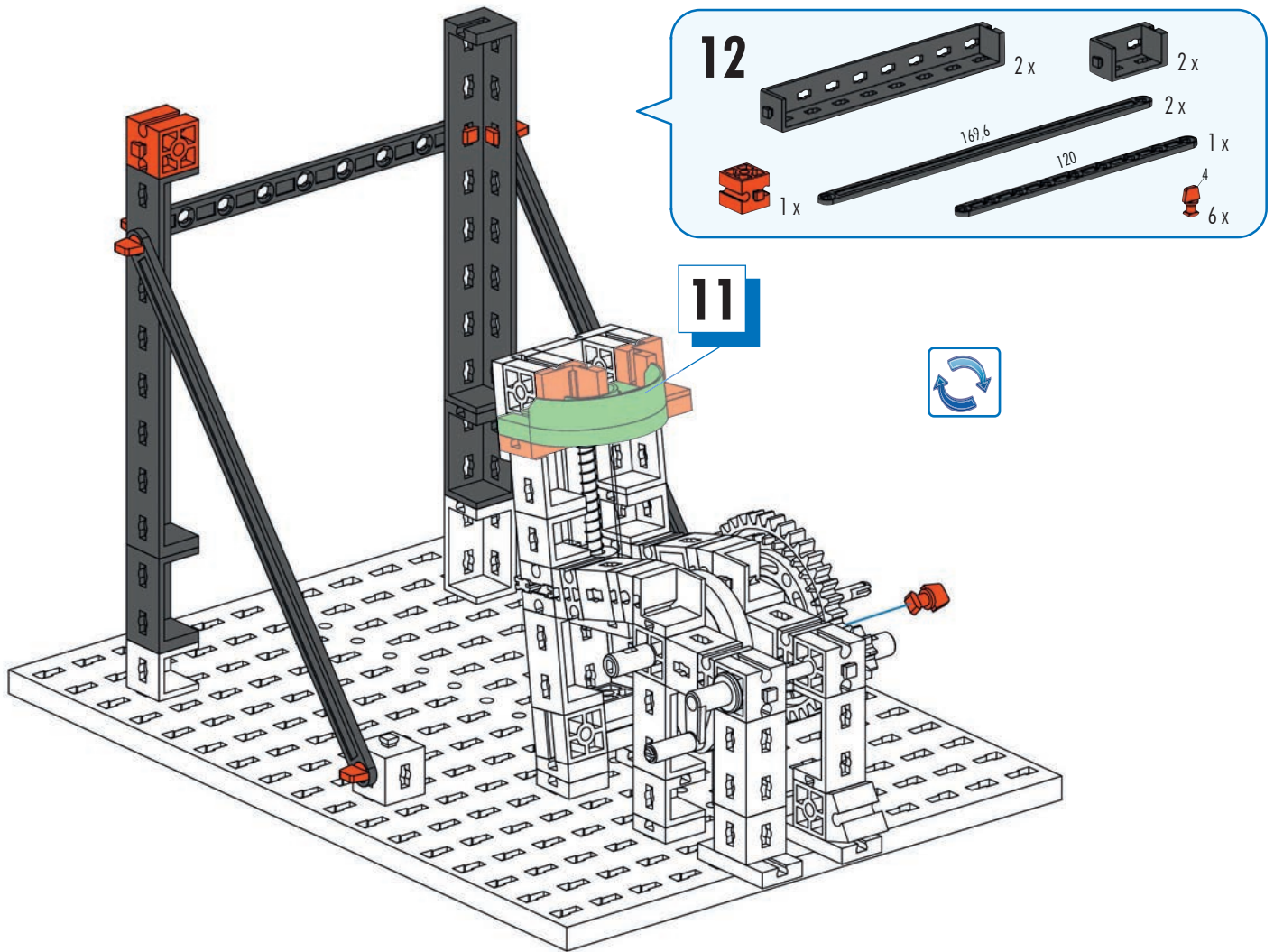

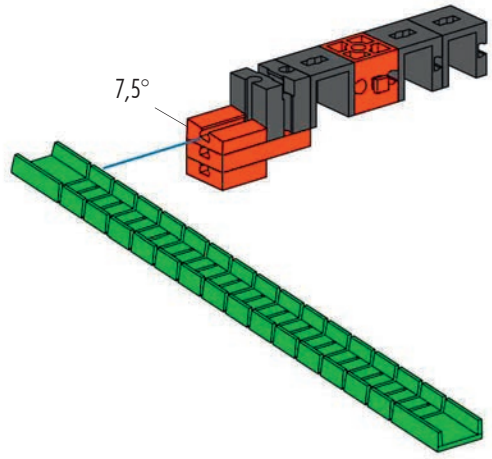
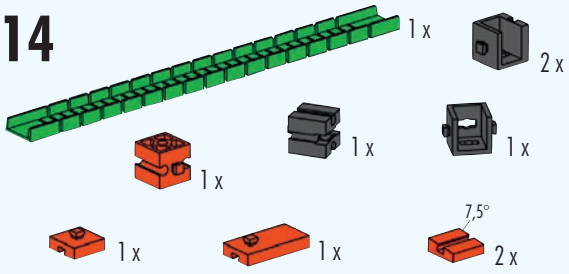

14



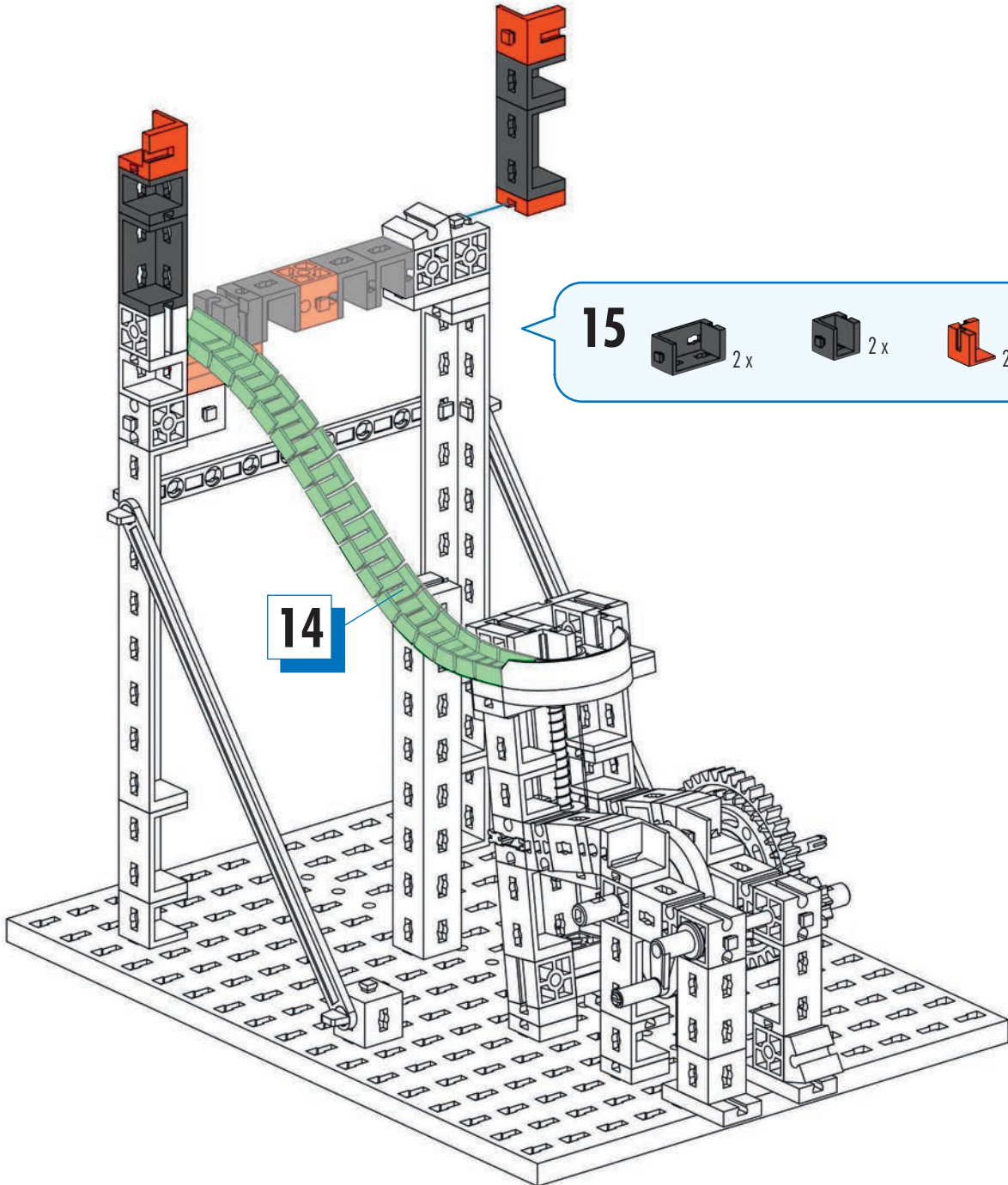
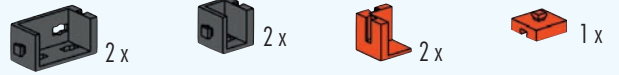

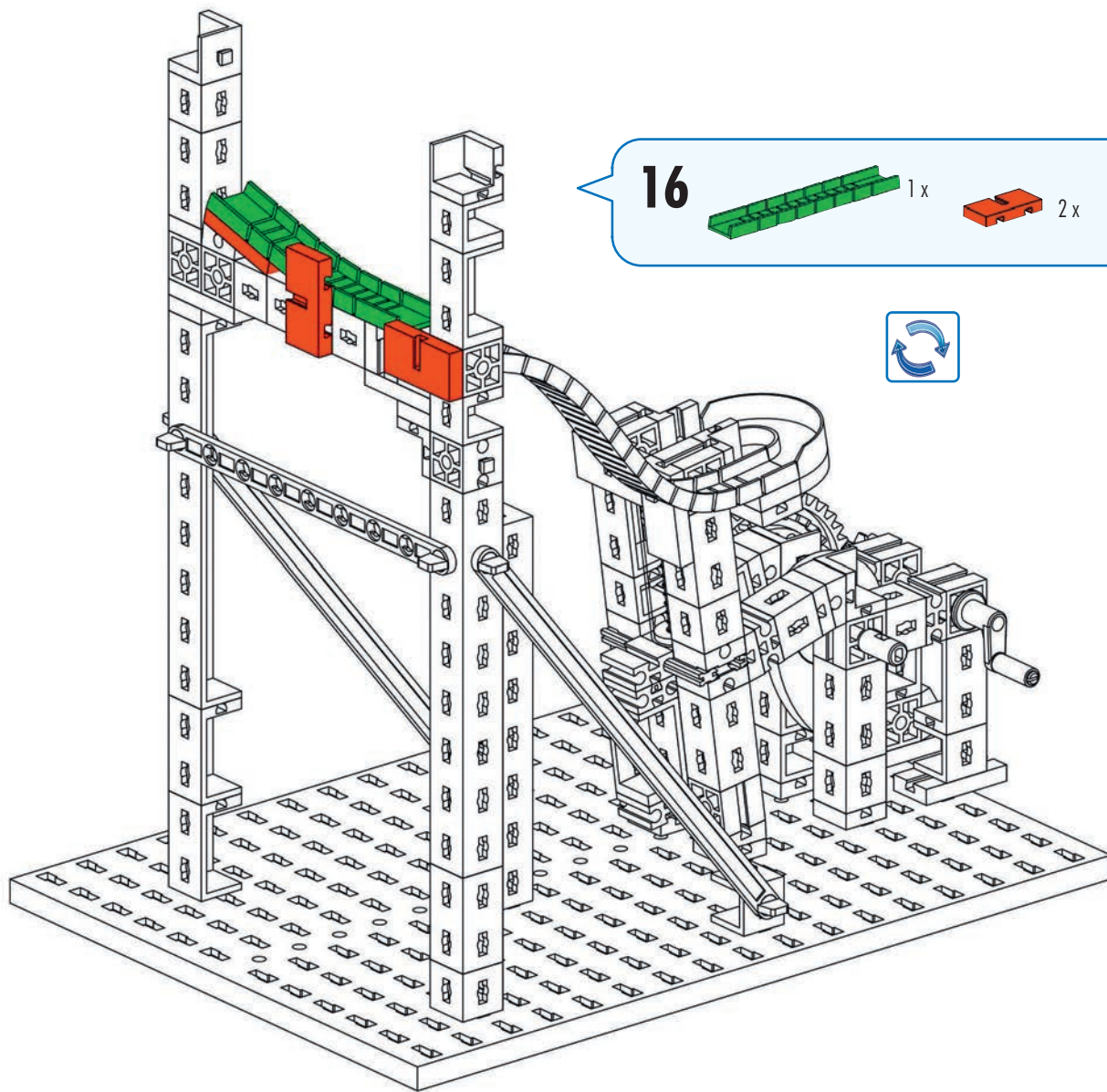
15

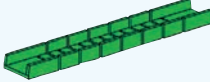

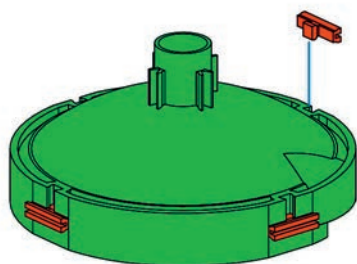

16  1x  2x  1x

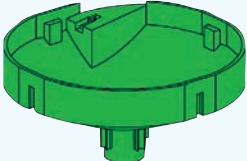

17  1x  3x

17

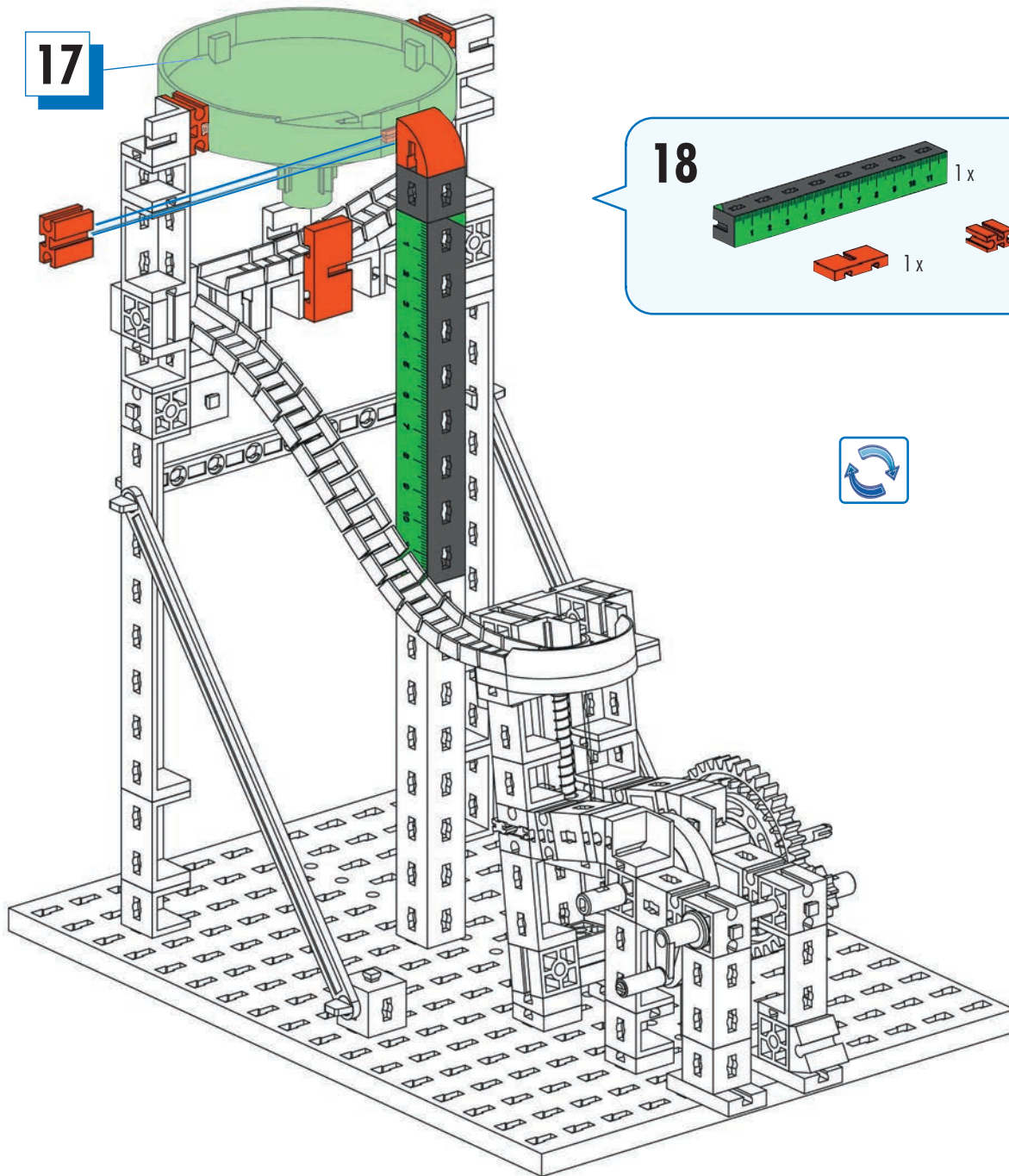

18

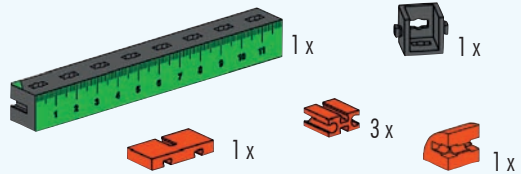

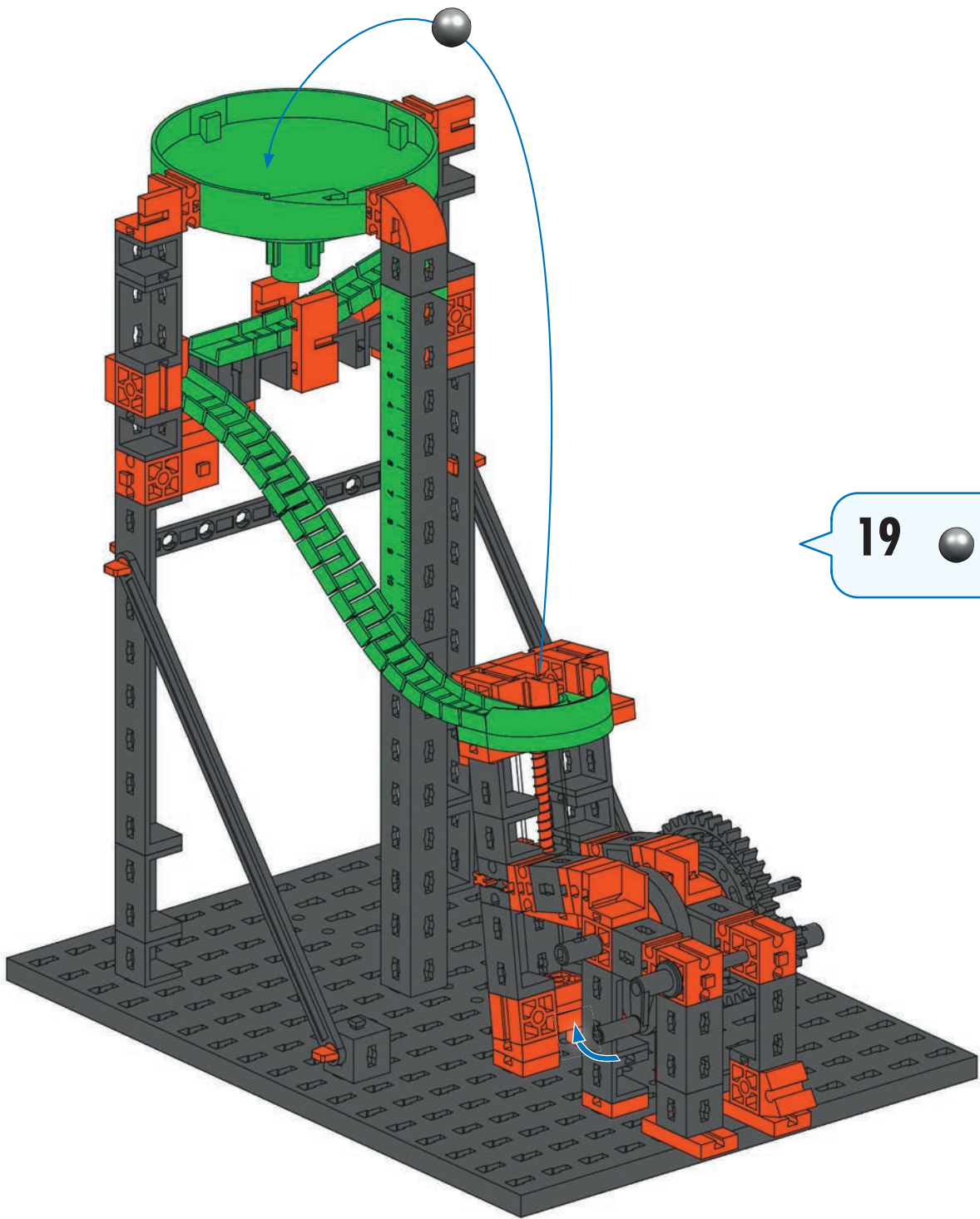

19 ● 1x



fischertechnik 

PROFI

fischertechnik GmbH
Klaus-Fischer-Str. 1
72178 Waldachtal
Germany
Phone: +49 74 43/12-43 69
Fax: +49 74 43/12-45 91
info@fischertechnik.de
www.fischertechnik.de

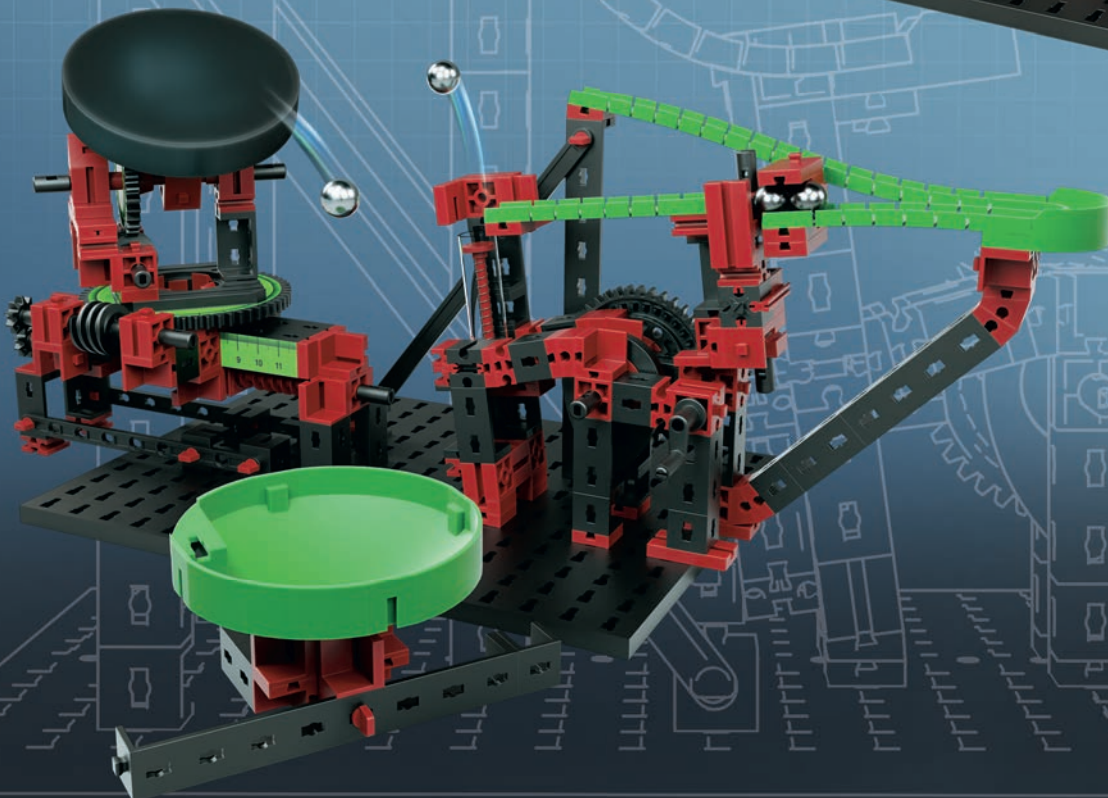

Dynamic XM

3 MODELS