

# STEM Simple Machines

Bauanleitung  
Assembly instruction  
Instructions de montage  
Bouwhandleiding  
Instrucciones de construcción  
Manual de montagem  
Istruzioni di montaggio  
Инструкция по сборке  
安装说明书

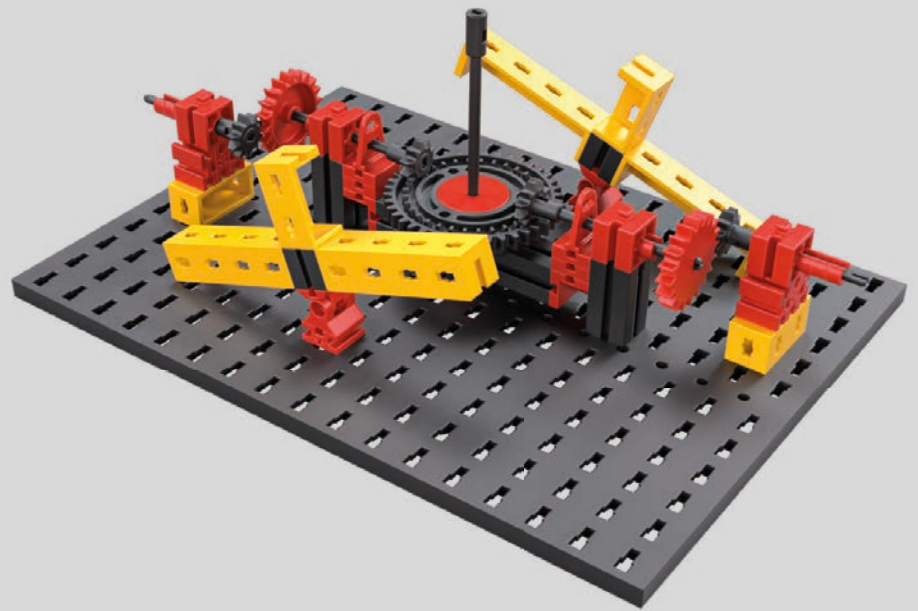

- Auf dem fischertechnik eLearning Portal bieten wir Ihnen die Möglichkeit, noch mehr Hintergrundwissen zum Thema des Baukastens zu erhalten und sich umfangreiche didaktische Begleitmaterialien für den Einsatz im Unterricht herunterzuladen. Über <https://www.fischertechnik.de/elearning-stem-simplemachines> gelangen Sie direkt zum eLearning Portal.
- On the fischertechnik eLearning portal, we offer you the opportunity to obtain even more background knowledge on the subject of the construction kit and to download extensive didactic accompanying materials for use in the classroom. You can access the eLearning portal directly via <https://www.fischertechnik.de/elearning-stem-simplemachines>.
- Avec le portail eLearning de fischertechnik, vous pouvez parfaire vos connaissances au sujet de la boîte de construction. Cliquez sur <https://www.fischertechnik.de/elearning-stem-simplemachines> pour accéder directement à notre portail.
- Met het fischertechnik eLearning portaal geven wij u de mogelijkheid, nog meer achtergrondkennis over het thema van het modulaire systeem te verkrijgen. Via <https://www.fischertechnik.de/elearning-stem-simplemachines> komt u direct bij het eLearning portaal.
- En el portal de eLearning de fischertechnik te ofrecemos la posibilidad de obtener aún más conocimientos de fondo sobre el tema del kit de construcción y de descargar amplios materiales didácticos de acompañamiento para utilizar en el aula. A través de <https://www.fischertechnik.de/elearning-stem-simplemachines> podrá acceder directamente al portal de aprendizaje electrónico.
- Com o portal de eLearning da fischertechnik damos lhe a possibilidade de obter ainda mais conhecimentos aprofundados sobre os kits de construção. Em <https://www.fischertechnik.de/elearning-stem-simplemachines> pode aceder diretamente ao portal de eLearning.
- Con il portale eLearning di fischertechnik vi diamo la possibilità di accumulare maggiori informazioni di base sul tema delle scatole di montaggio. Tramite <https://www.fischertechnik.de/elearning-stem-simplemachines> potete raggiungere direttamente il portale eLearning.
- Обучающий Интернет-портал компании fischertechnik предлагает вам возможность получить больше базовых знаний по теме конструирования. По ссылке <https://www.fischertechnik.de/elearning-stem-simplemachines> вы попадаете прямо на обучающий Интернет-портал.
- 通过 fischertechnik eLearning 电子学习门户网站，我们为您提供更多关于积木的背景知识。登陆 <https://www.fischertechnik.de/elearning-stem-simplemachines> 访问我们的 elearning 门户网站。

<https://www.fischertechnik.de/elearning-stem-simplemachines>



**Inhalt**  
**Contents**  
**Contenu**

**Inhoud**  
**Contenido**  
**Conteúdo**

**Contenuto**  
**Содержание**  
**目录**

Einzelteilübersicht / Spare parts list / Liste des pièces détachées / Onderdelenoverzicht / Lista da piezas / Resumo de peça individual /  
Singoli componenti / Перечень деталей / 零件概览 ..... 3

Montagetipps / Tips for assembly / Tuyaux pour le montage / Montagetips / Consejos para el montaje / "Dicas" para montagem /  
Consigli per il montaggio / Советы по сборке / 装配建议 ..... 5

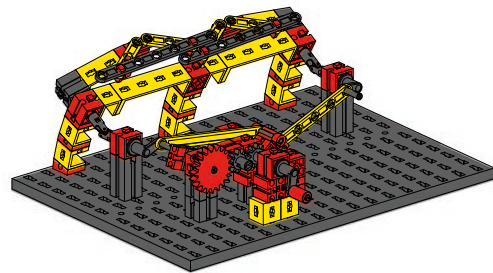
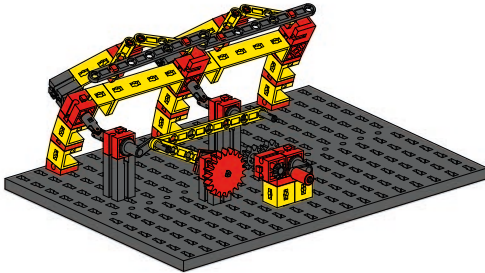

Scheibenwischer - gleichläufig / Windshield wiper - concurrent / Essuie-glace - synchronisé / Ruitenwissers - gelijklopend / Limpiaparabrisas - concurrente / Limpador de pára-brisas - concorrentes / Tergicristalli - concorrenti / Стеклоочистители ветрового стекла - одновременные / 并行雨刮器..... 6

Scheibenwischer - gegenläufig / Windshield wiper - counterrotating / Essuie-glace - à contre-sens / Ruitenwissers - tegengesteld draaiend / Limpiaparabrisas - contra-rotación / Limpador de pára-brisas - contra-rotativo / Tergicristalli - controrotanti / Стеклоочистители ветрового стекла - противовращающиеся / 对刮式雨刮器..... 11

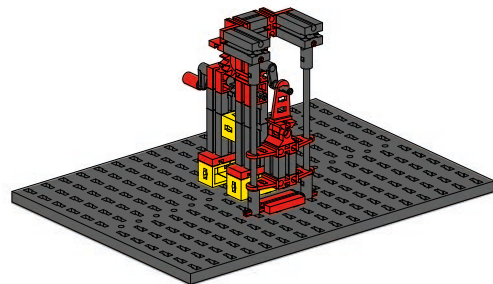
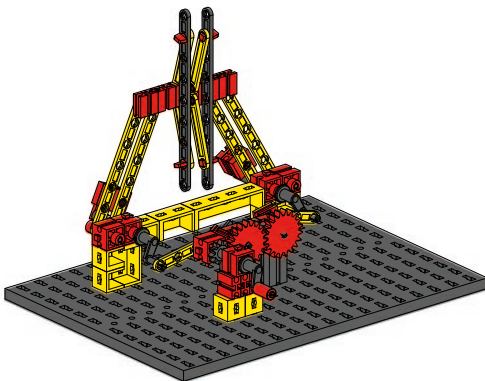

Scheibenwischer - parallel / Windshield wiper - parallel / Essuie-glace - parallèle / Ruitenwissers - parallel / Limpiaparabrisas - paralelo .. / Limpador de pára-brisas - paralelo / Tergicristalli - paralleli / Стеклоочиститель ветрового стекла - параллельно / 平行式雨刮器..... 17

Exzenterpresse / Eccentric press / Presse à excentrique / Excentrische pers / Prensa excéntrica / Prensa excéntrica / Pressa eccentrica / Эксцентрический пресс / 偏心压力机..... 23

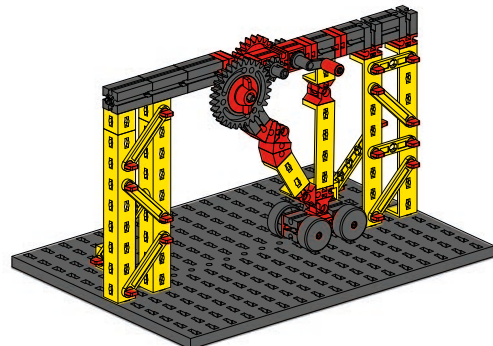
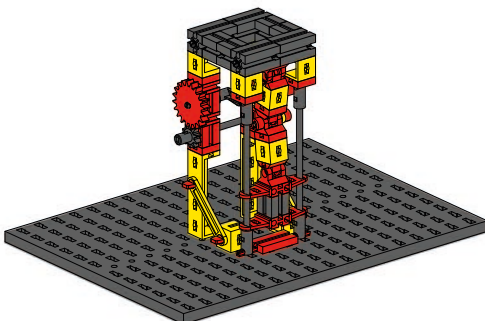

Kniehebelpresse / Toggle press / Presse à genouillère / Kniehefboompers / Pulsar el botón / Alternar a prensa / Premere il pulsante / Тумблерное нажатие / 切换式压力机..... 26

Kniegelenk mit Überstreckung / Knee joint with hyperextension / Articulation du genou avec hyperextension / Kniegewricht met hyperextensie / Articulación de la rodilla con hiperextensión / Joelho articulado com hiperextensão / Articolazione del ginocchio con iperestensione / Коленный сустав при гиперэкстензии / 膝关节伸展器..... 30

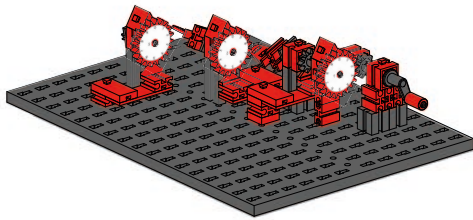

Zählwerk / Counter / Compteur / Telwerk / Contador / Contador / Contatore /  
Счетчик / 计数器.....34

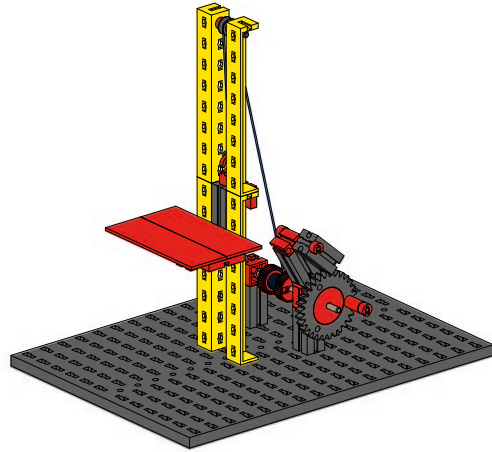

Aufzug / Elevator / Ascenseur / Lift / Ascensor / Elevação / Elevatore /  
Подъемник / 电梯.....38

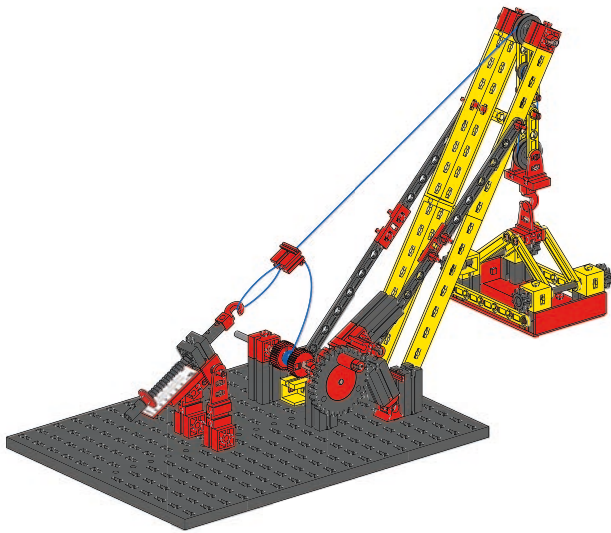

Flaschenzug / Pulley block / Poulie / Katrolblok / Bloque de poleas / Bloco de polias /  
Pulegge / Блок шкивов / 滑轮组.....42

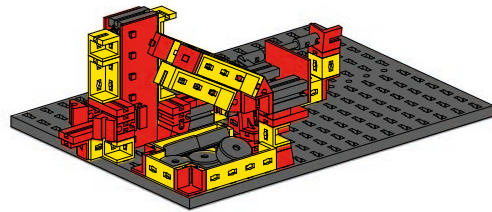

Warenautomat / Vending machine / Distributeur automatique de marchandises /  
Verkoopautomaat / Máquina expendedora / Máquina de venda automática /  
Distributore automatico / Торговый автомат /  
自动售货机.....50

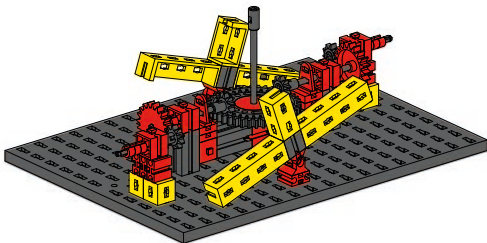

Ausgleichsgetriebe / Differential gear / Réducteur de compensation / Differentieel  
/ Engranaje diferencial / Engrenagem diferencial / Ingranaggio differenziale /  
Дифференциальная передача / 差速器齿轮.....55

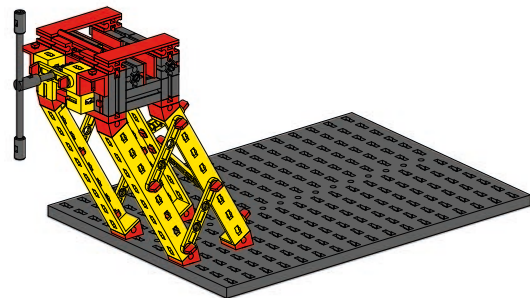

Schraubstock / Vise / Etai / Bankschroef / Tornillo de banco / Torno de bancada /  
Morsa a vite / Тиски / 虎钳.....59





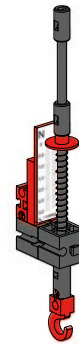

Schiefe Ebene / Inclined plane / Plan incliné / Hellend vlak / Plano inclinado /  
Plano inclinado / Piano inclinato / Наклонная плоскость / 斜面.....65







Federwaage / Spring scale / Balance à ressort / Lente schaal / Báscula de resorte / Escala  
de mola / Scala a molla / пружинные весы / 春天的尺度.....76



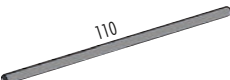
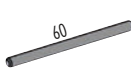







**Einzelteilübersicht**  
**Spare parts list**  
**Liste des pièces détachées**















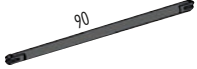







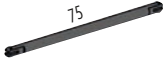





















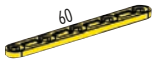



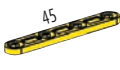
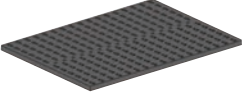









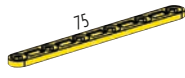



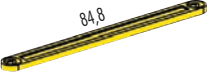

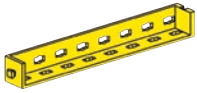

	31 010 3 x
	31 011 9 x
	31 016 1 x
	31 020 2 x
	31 022 1 x

**Onderdelenoverzicht**  
**Lista da piezas**  
**Resumo de peça individual**

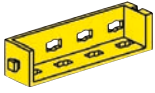
	31 031 1 x
	31 032 1 x
	31 058 1 x
	31 060 6 x
	31 061 2 x

**Singoli componenti**  
**Перечень деталей**  
**零件概览**

	31 124 4 x		31 602 3 x
	31 330 1 x		31 667 2 x
	31 426 5 x		31 668 4 x
	31 436 5 x		31 690 4 x
	31 597 4 x		31 848 8 x

	31 981 5 x		35 065 2 x		36 299 3 x		38 413 3 x
	31 982 11 x		35 066 2 x		36 323 18 x		38 414 2 x
	31 983 1 x		35 073 4 x		36 574 6 x		38 416 1 x
	32 064 12 x		35 087 2 x		36 586 2 x		38 423 2 x
	32 071 6 x		35 088 3 x		37 237 8 x		38 428 4 x
	32 321 1 x		35 797 2 x		37 238 2 x		38 464 2 x
	32 869 1 x		35 945 4 x		37 468 15 x		38 531 4 x
	32 879 9 x		35 971 4 x		37 679 8 x		38 538 4 x
	32 881 14 x		35 972 2 x		38 225 2 x		38 540 4 x
	32 882 4 x		35 973 1 x		38 240 8 x		38 541 4 x
	32 985 1 x		35 975 2 x		38 241 2 x		38 542 5 x
	35 031 1 x		35 977 1 x		38 242 4 x		38 543 2 x
	35 049 8 x		35 981 1 x		38 244 1 x		38 545 2 x
	35 053 7 x		36 227 5 x		38 248 1 x		38 546 2 x
	35 058 4 x		36 264 1 x		38 251 2 x		130 593 3 x
	35 061 1 x		36 294 7 x		38 253 4 x		137 677 3 x
	35 063 4 x		36 297 8 x		38 258 2 x		167 984 1 x
	35 064 3 x		36 298 5 x		38 260 2 x		193 732 1 x

**Montagetipps**  
**Tips for assembly**  
**Tuyaux pour le montage**

**Montagetipps**  
**Consejos para el montaje**  
**"Dicas" para montagem**

**Consigli per il montaggio**  
**Советы по сборке**  
**装配建议**

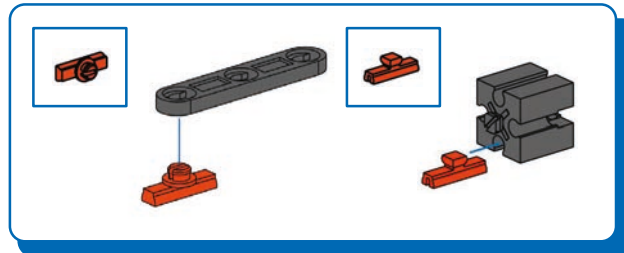
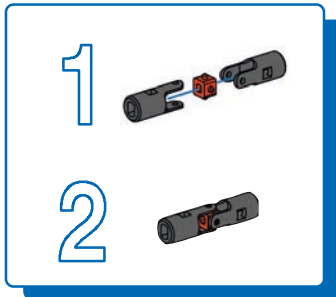
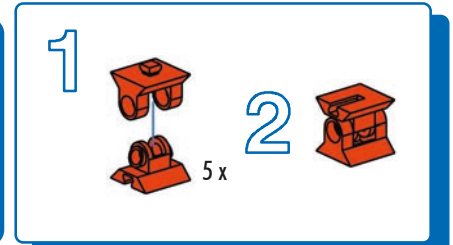
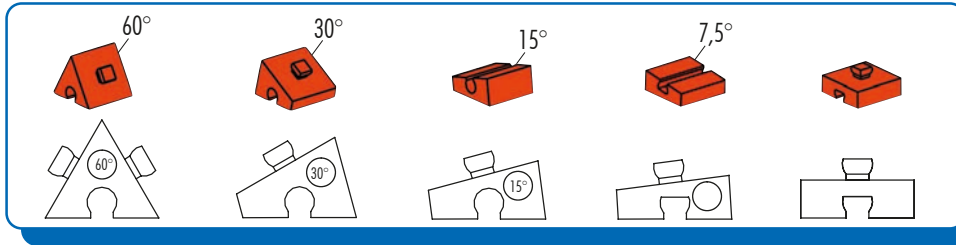

**Sicherheitshinweise**  
**Safety Information**  
**Consignes de sécurité**

**Veiligheidsrichtlijnen**  
**Indicaciones de seguridad**  
**Observações sobre segurança**

**Informazioni per la sicurezza**  
**Указания по технике безопасности**  
**安全指南**

- Achtung! Verletzungsgefahr an Bauteilen mit funktionsbedingten scharfen Kanten und Spitzen!
- Caution! Be careful not to hurt yourself on components with sharp or pointed edges!
- Attention! Risque de blessure sur les éléments comportant des arêtes et o pointes vives indispensables au bon fonctionnement!
- Let op! U kunt zich bezeren aan bouwstenen met sherpe randen of punten!
- Atención! icuidado, no te hagas daño con los componentes con bordes afilados o puntiagudos!

- Atenção! Perigo de ferimentos em peças componentes com cantos vivos e pontas obrigatórios para o funcionamento!
- Attenzione! Pericolo di lesioni dovute a componenti con spigoli vivi e punte per motivi funzionali!
- Будьте осторожны! Об острые края деталей и и наконечники можно порезаться!
- 注意！因功能需要而带有锋利的棱边和尖角的部件可能会带来受伤危险！

- Alle Einzelteile, insbesondere bewegliche Teile sind falls notwendig zu warten und zu reinigen.
- All components, especially moving parts, should be maintained and cleaned as necessary.
- Toutes les pièces détachées et en particulier les pièces mobiles, sont, si nécessaire, à entretenir et à nettoyer.
- Alle onderdelen, vooral de bewegende delen, kunnen, indien noodzakelijk, onderhouden en gereinigd worden.
- Es necesario mantener limpio y en buen estado cada una de las piezas. Particularmente las piezas móviles.

- Todas as peças individuais, especialmente peças móveis, devem ser submetidas à manutenção e limpas se necessário.
- Se necessario, tutti i singoli componenti, soprattutto le parti mobili, si devono eventualmente sottoporre a manutenzione e pulizia.
- Все детали, особенно подвижные, требуют ухода и чистки.
- 必要时应保养和清洁所有零件，尤指运动部件。



Hinweise zum Umweltschutz / Instructions for Environmental Protection / Remarques de protection de l'environnement / Bescherming van het milieu / Notas con respecto a la protección del medio ambiente / Instruções para a proteção do meio ambiente / Indicazioni sulla tutela ambientale / Указания по охране окружающей среды / 有关环保的提示：

[www.fischertechnik.de/environment](http://www.fischertechnik.de/environment)

Scheibenwischer - gleichläufig  
 Windshield wiper - concurrent  
 Essuie-glace - synchronisé  
 Ruitenwissers - gelijklopend

Limpiaparabrisas - concurrente  
 Limpador de pára-brisas -  
 concurrentes  
 Tergicristalli - concorrenti

Стеклоочистители  
 ветрового стекла -  
 одновременные  
 并行雨刮器

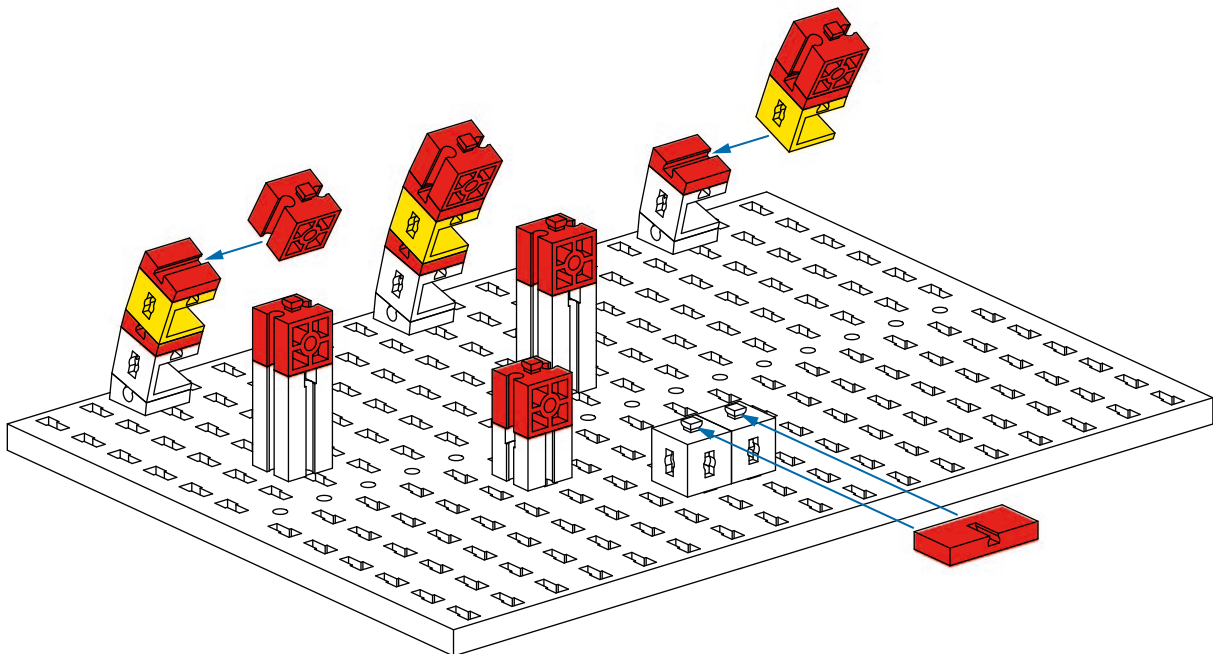
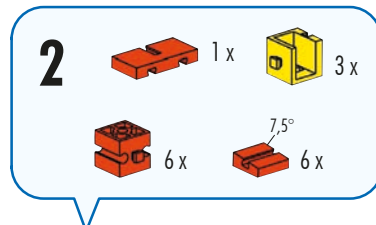
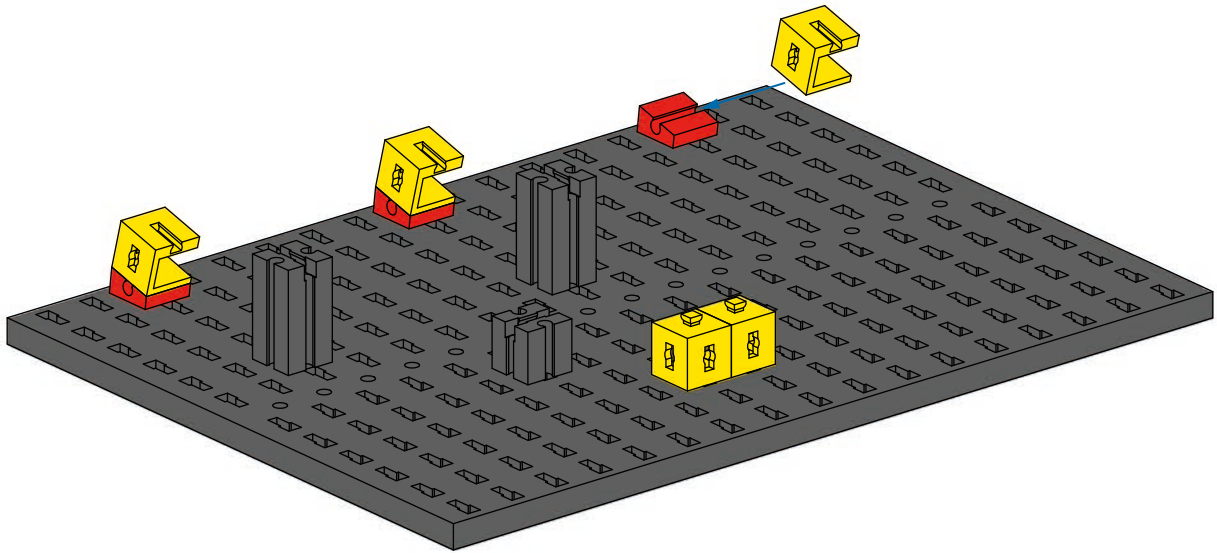
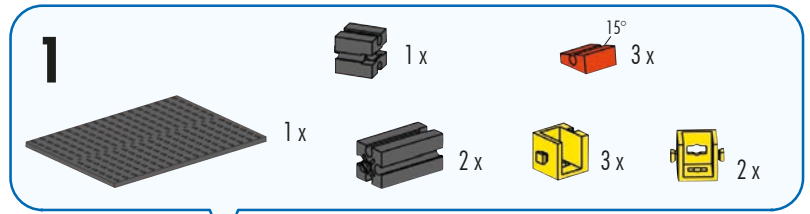
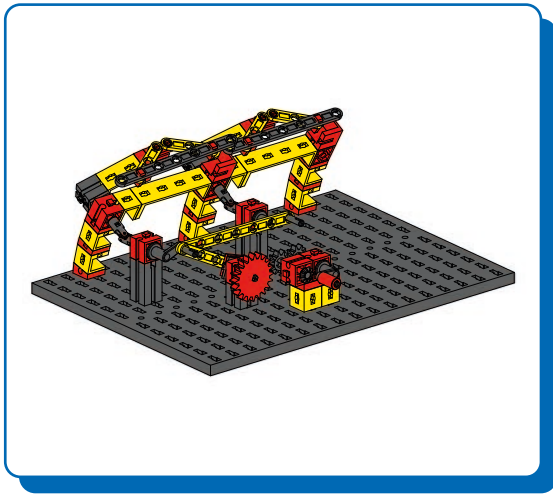



**3**

- 2 x Yellow Technic Beam 1x7
- 2 x Red Technic Connector
- 2 x Yellow Technic Pin

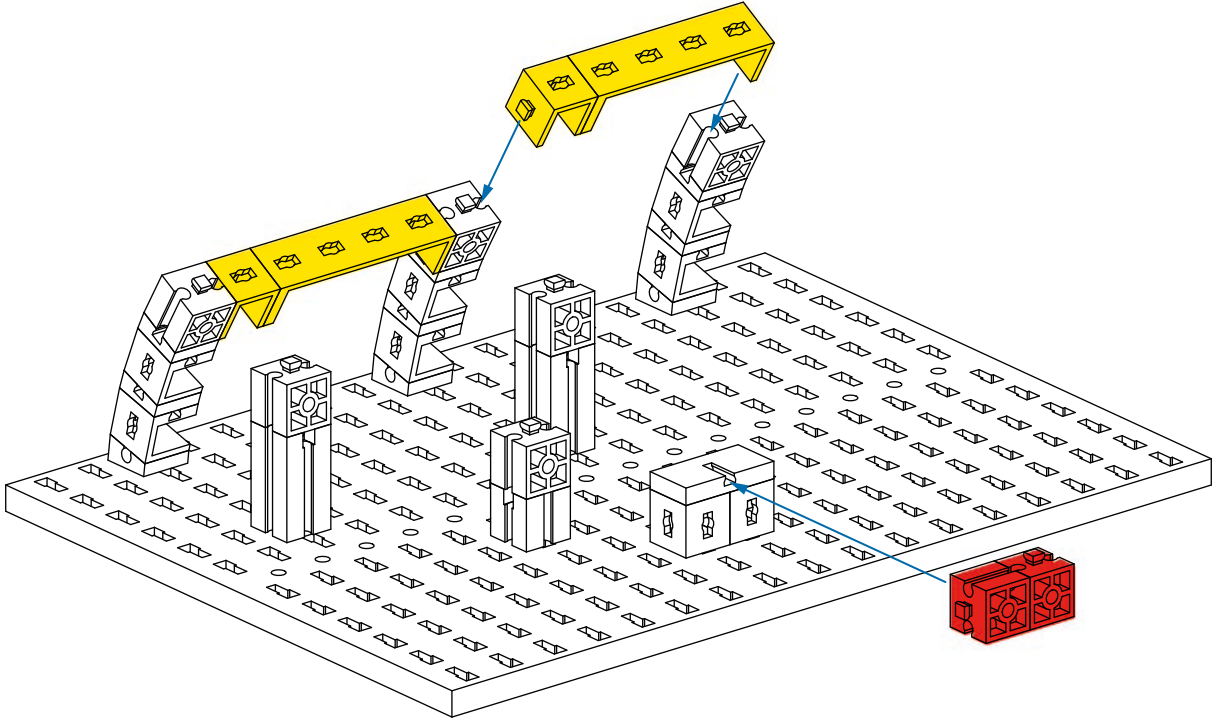

**4**

- 2 x Black Technic Pin
- 2 x Black Technic Pin
- 2 x Black Technic Pin
- 2 x Black Technic Pin

30 mm

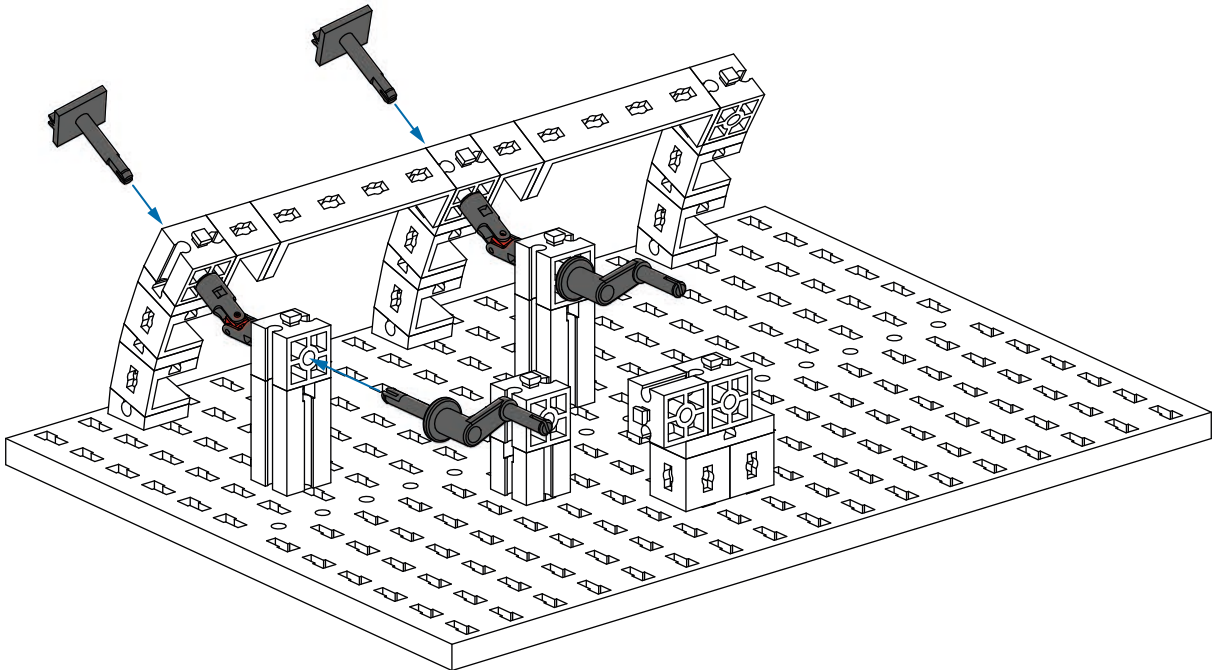

- 5**
- 2x (Orange Technic L-Shape)
  - 1x (Orange Technic 1x2 Plate)
  - 1x (Grey Technic Pin)
  - 1x (Red Technic Gear)
  - 1x (Red Technic Pin)

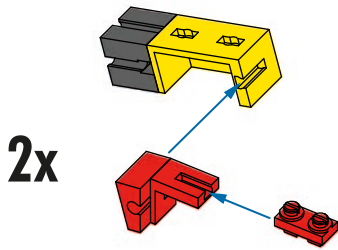
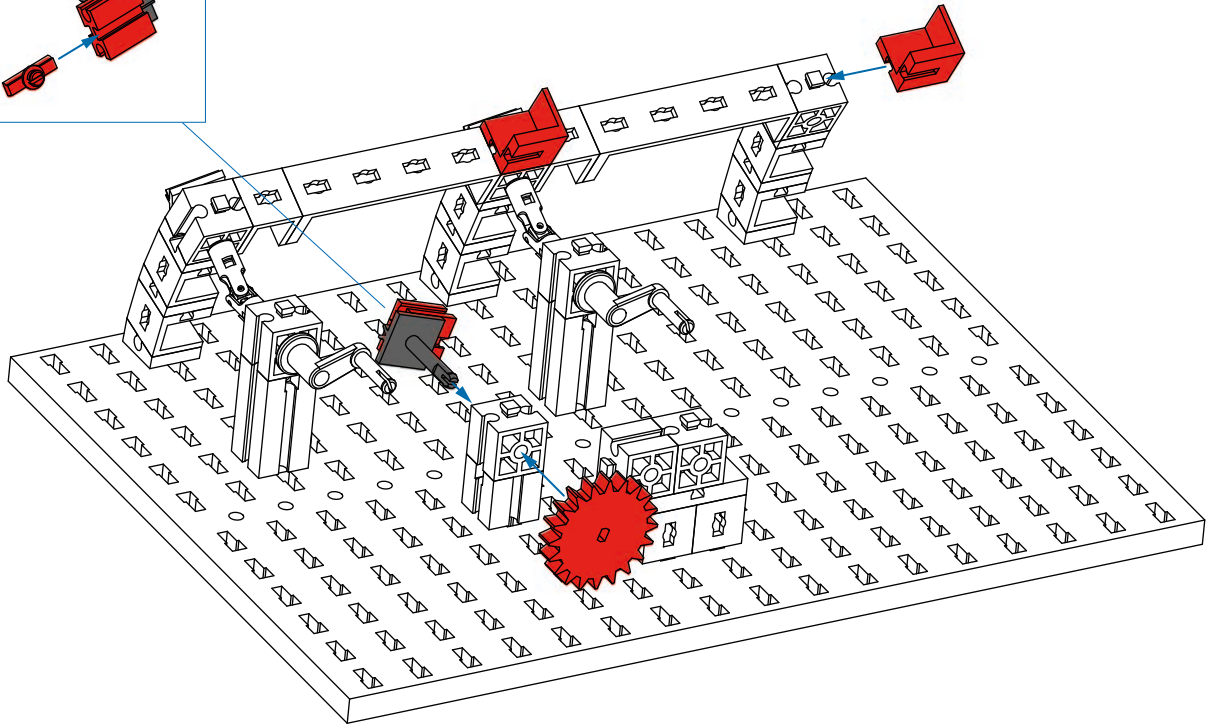
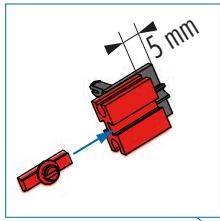

- 6**
- 2x (Grey Technic Pin)
  - 2x (Orange Technic 15° Wedge)
  - 2x (Yellow Technic L-Shape)
  - 2x (Red Technic L-Shape)
  - 2x (Red Technic Pin)



- 7**
- 4x (Yellow Technic Beam 30)
  - 2x (Black Technic Beam 90)
  - 4x (Red Technic Pin A)

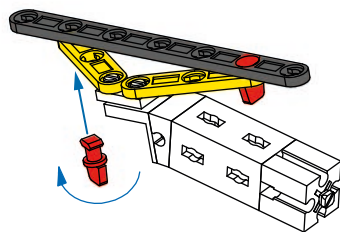

**2x**



**8** 90 1x 45 1x

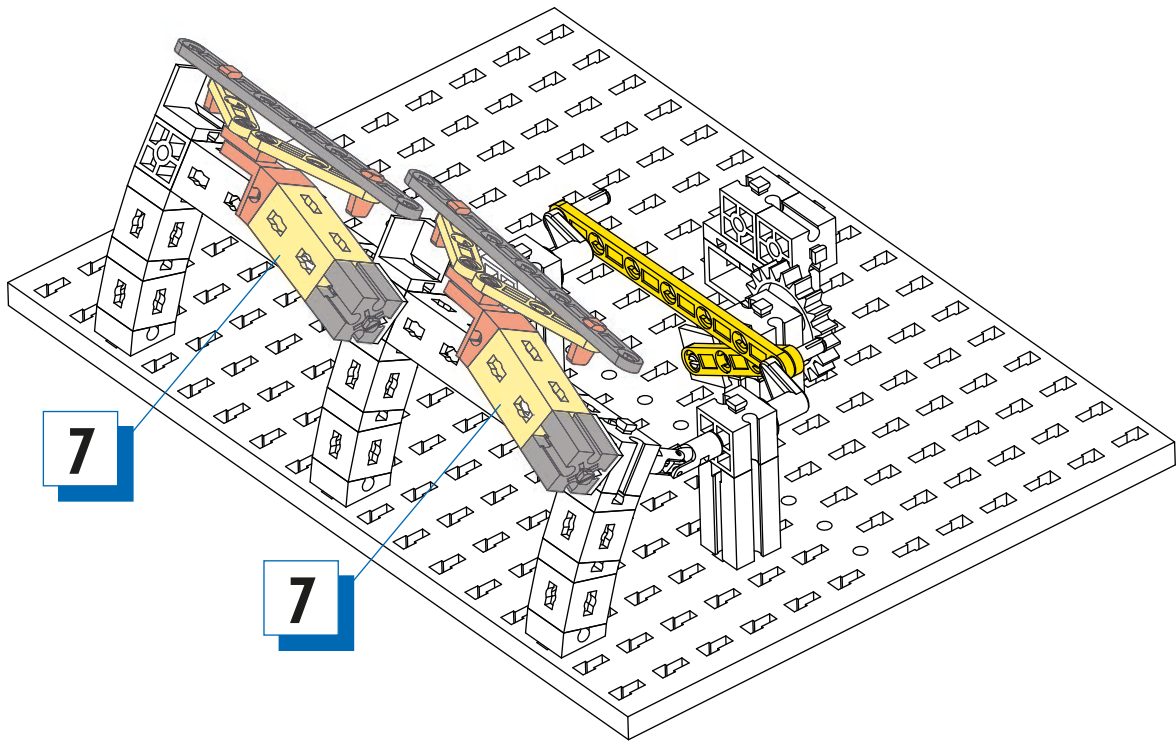

30 mm

**9** 2x 1x 30 1x 1x 1x

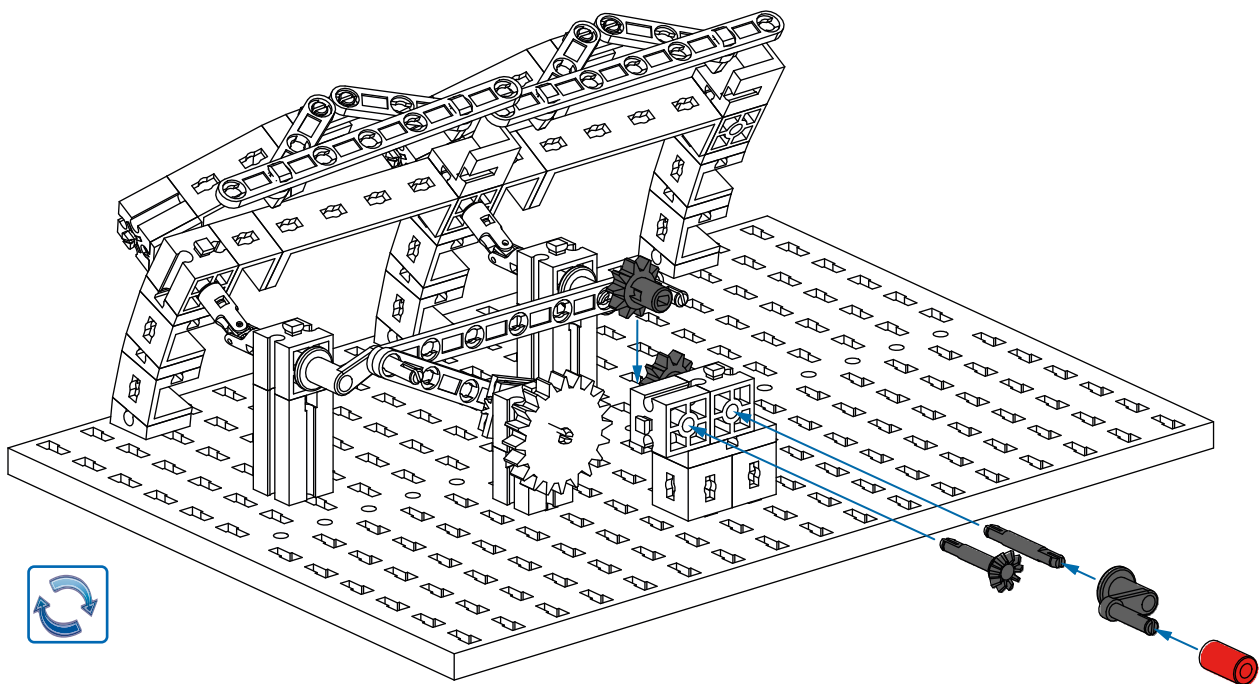

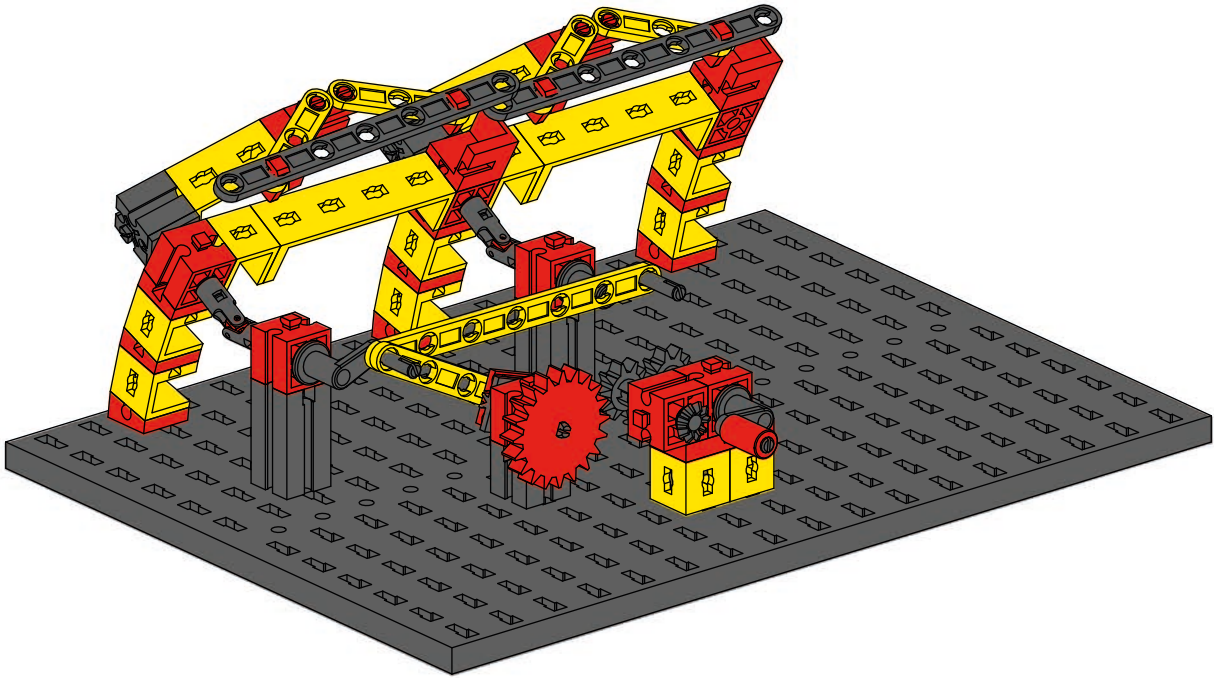

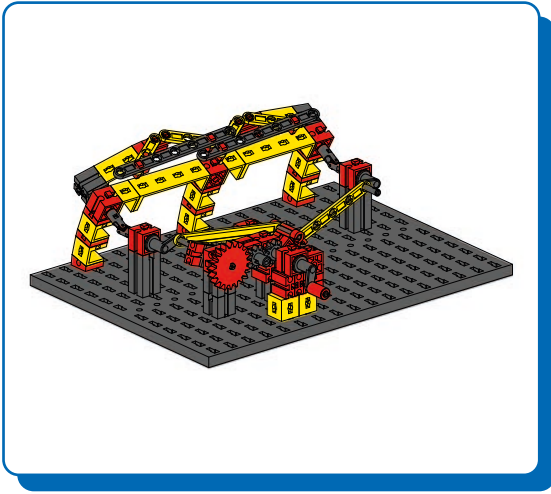

Scheibenwischer - gegenläufig  
 Windshield wiper - counterrotating  
 Essuie-glace - à contre-sens  
 Ruitenwisser - tegengesteld draaiend

Limpiaparabrisas - contra-rotación  
 Limpador de pára-brisas -  
 contra-rotativo  
 Tergicristalli - controrotanti

Стеклоочистители  
 ветрового стекла -  
 противовращающиеся  
 对刮式雨刮器

**1**

1x 1x1 grey plate  
 1x 1x2 grey axle  
 2x 1x2 grey axle  
 1x 1x2 grey axle  
 1x 1x2 grey axle  
 3x 1x2 yellow axle  
 3x 1x2 red axle  
 4x 1x2 red axle  
 3x 15° red Technic brick  
 1x 15° red Technic brick

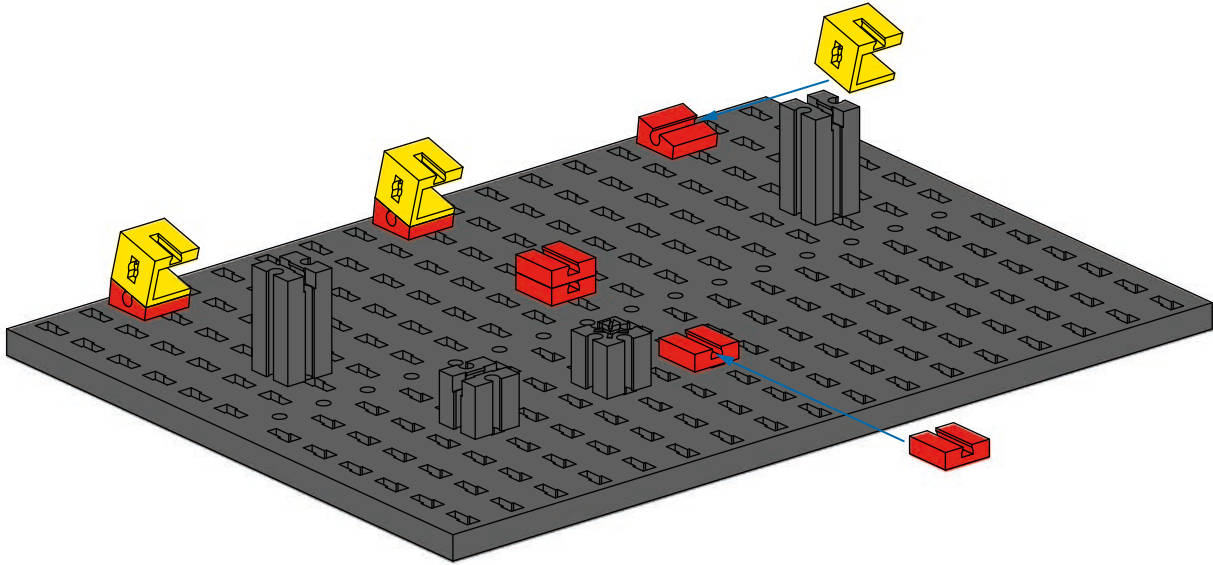

**2**

1x 1x2 grey axle  
 3x 1x2 yellow axle  
 3x 1x2 red axle  
 6x 7.5° red Technic brick

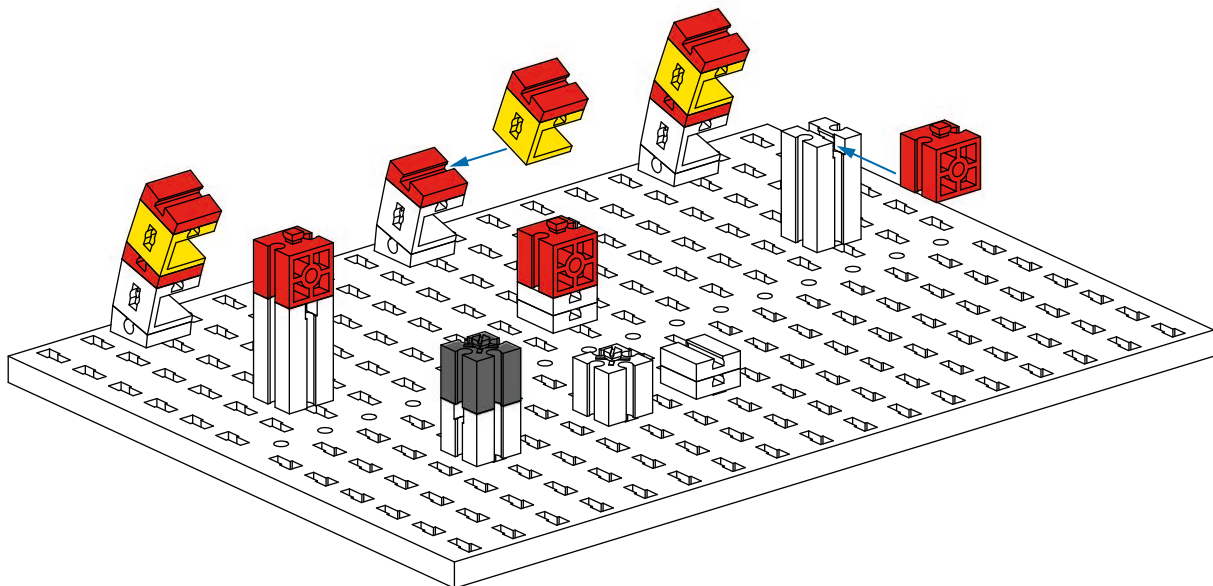
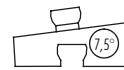

**3**

- 2 x
- 5 x
- 1 x
- 2 x

60 mm

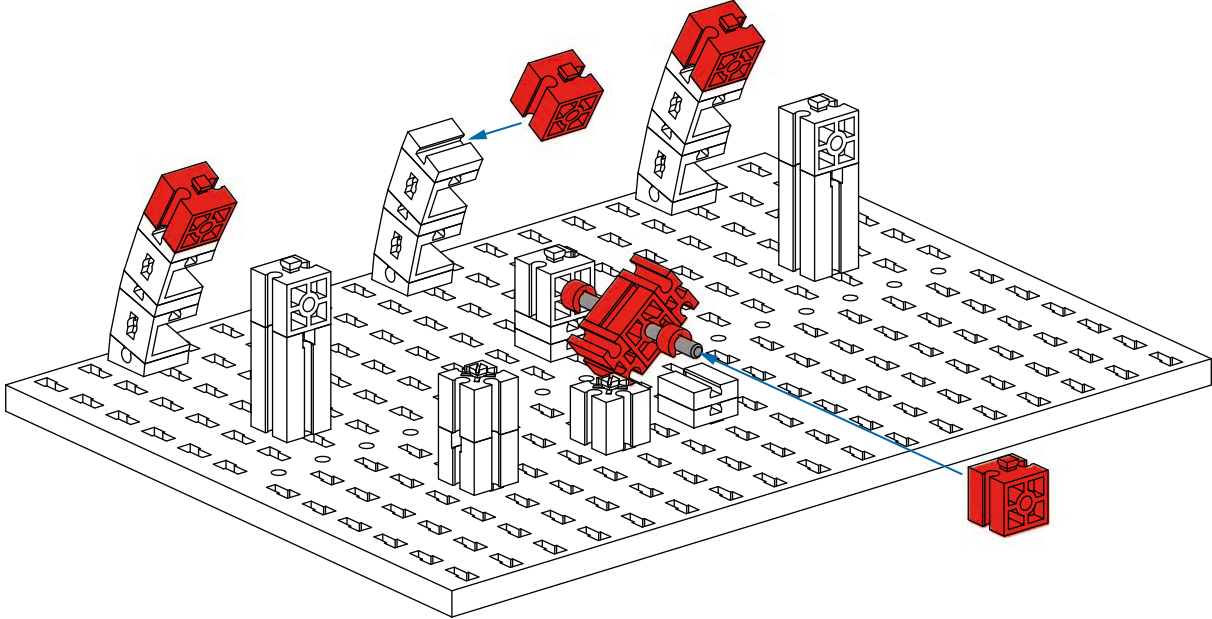

**4**

- 1 x
- 2 x
- 2 x
- 4 x

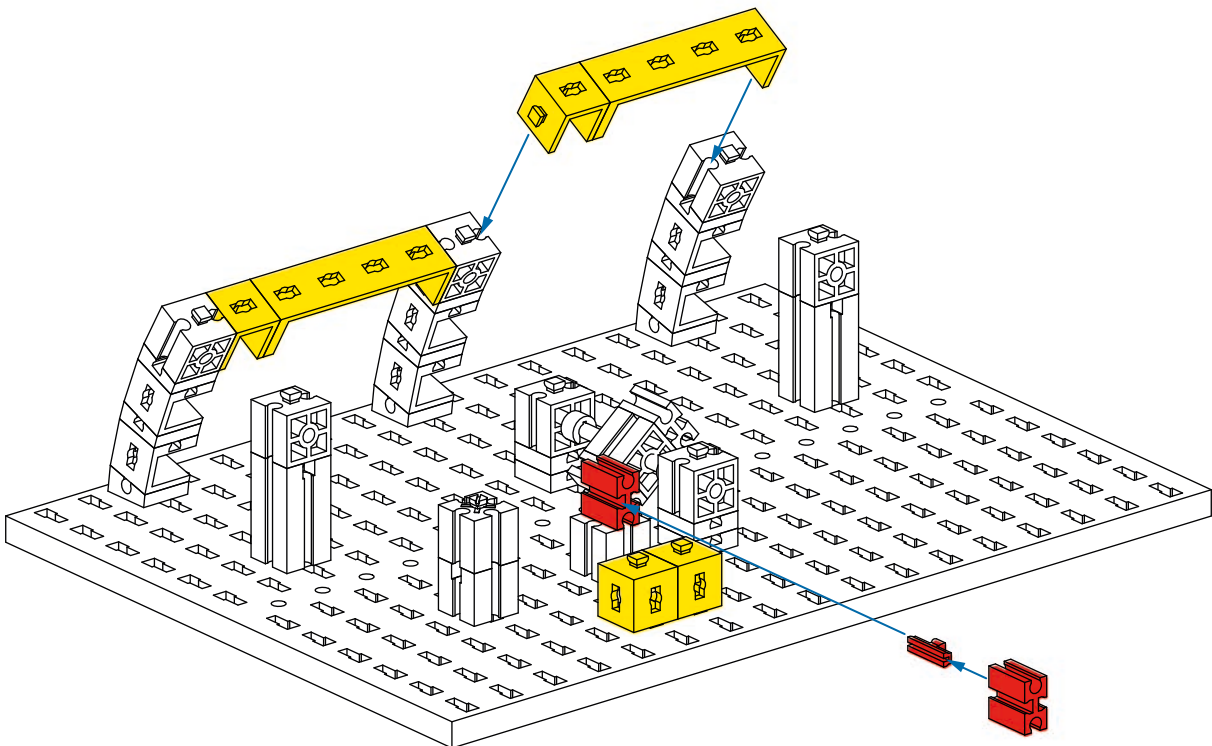

- 5**
- 2 x
  - 3 x
  - 4 x

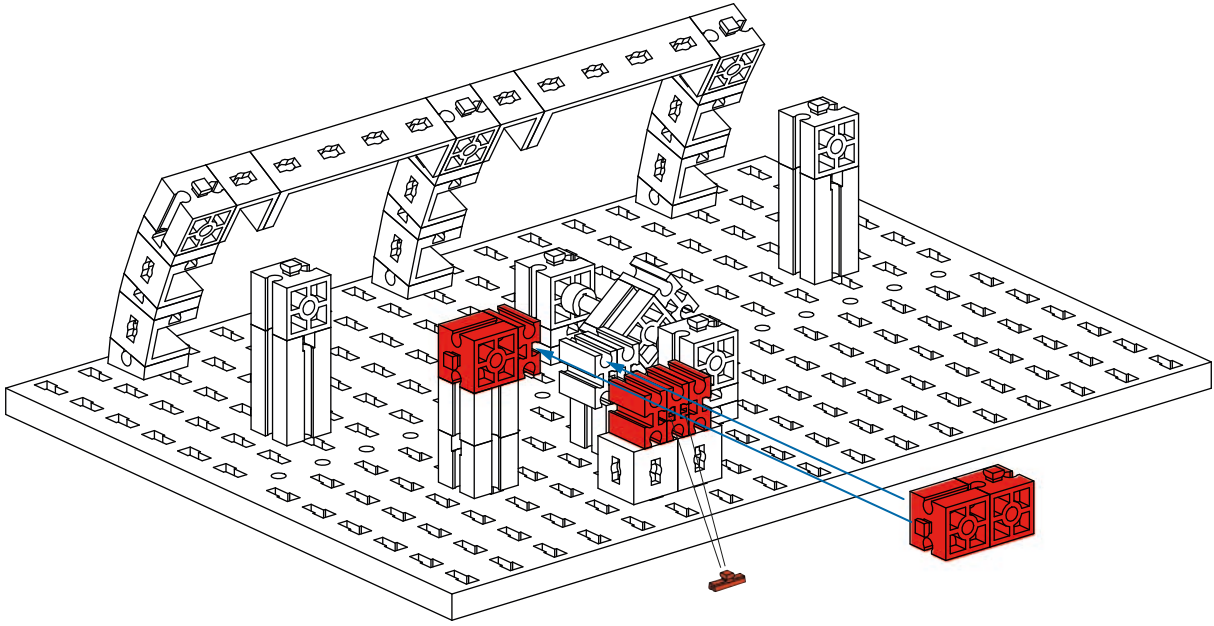

- 6**
- 1 x
  - 2 x
  - 1 x
  - 1 x
  - 1 x
- 30 mm

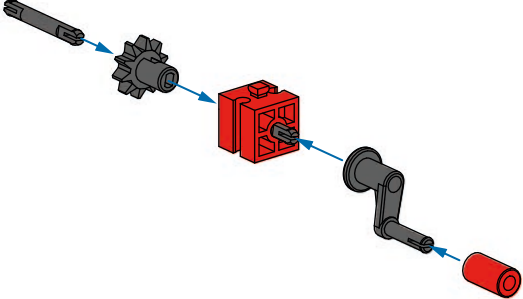

- 7**
- 1 x
  - 1 x
  - 1 x
  - 1 x

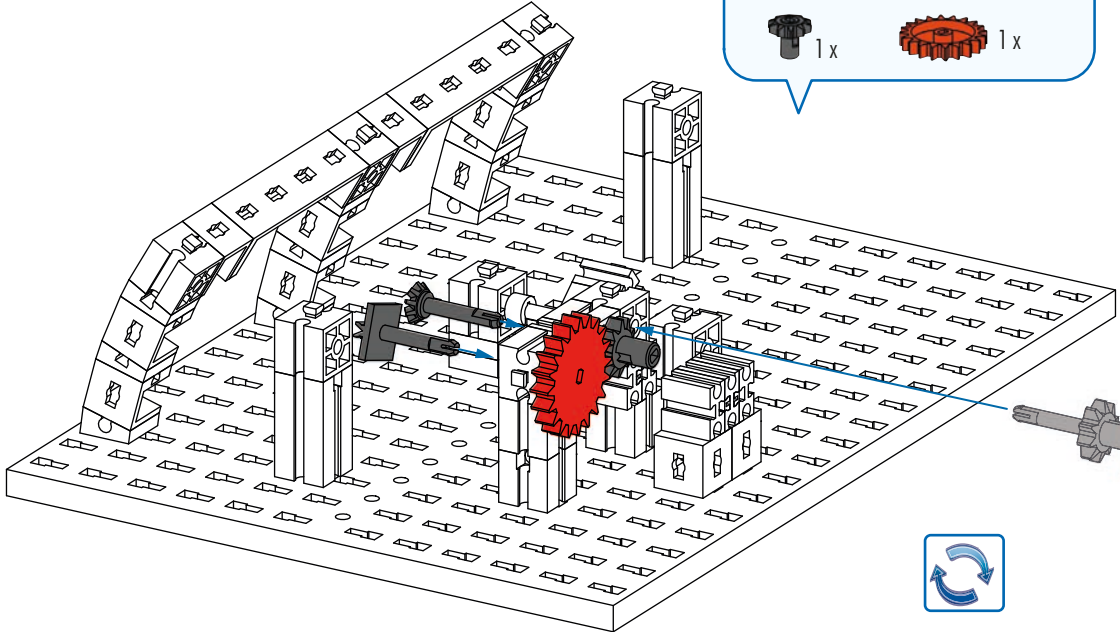

**6**

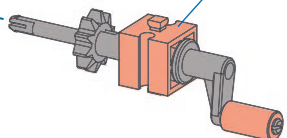

**8**

- 1 x (red 1x3 Technic brick)
- 2 x (red 1x2 Technic brick)
- 1 x (yellow 1x75 Technic axle)
- 1 x (red 1x2 Technic axle pin)
- 1 x (grey 1x30 Technic axle)

30 mm

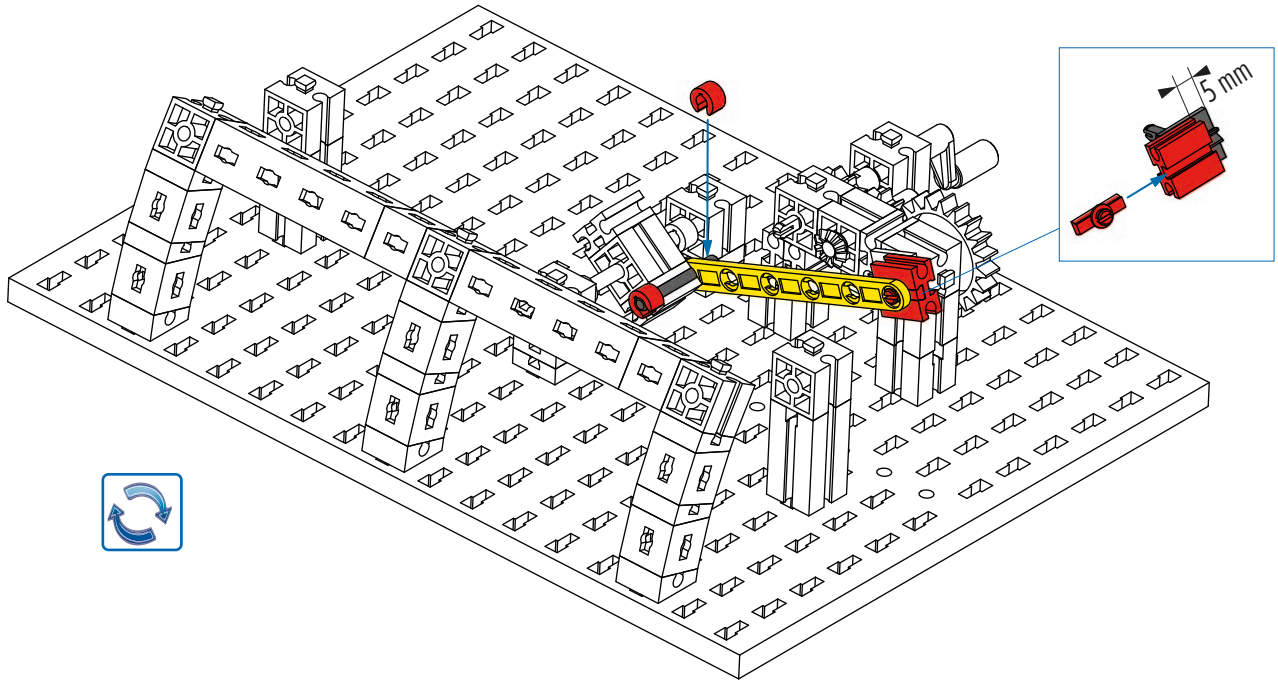

**9**

- 2 x (grey 1x2 Technic axle)
- 2 x (grey 1x30 Technic axle)
- 2 x (grey 1x2 Technic axle pin)
- 2 x (grey 1x2 Technic axle pin)

30 mm

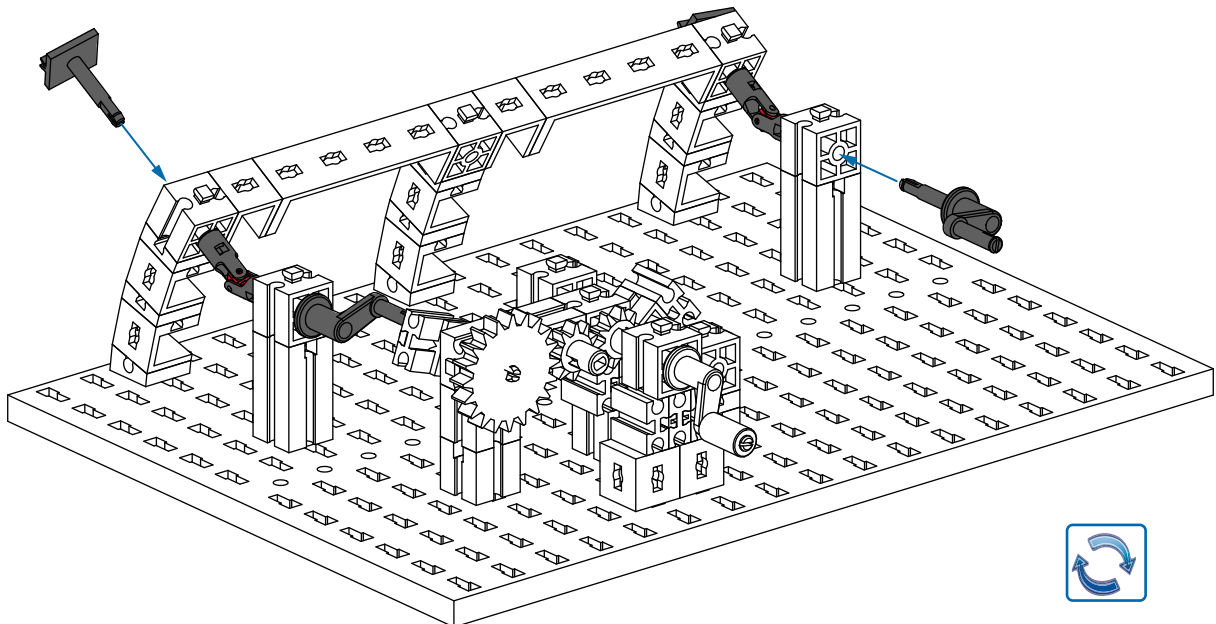



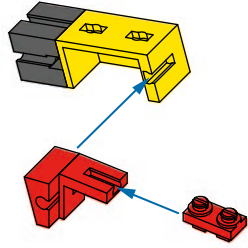

**10**

- 1x grey 2-hole Technic brick
- 1x red 1-hole Technic brick
- 1x yellow 1-hole Technic brick
- 1x red 1-hole Technic brick
- 1x red 2-hole Technic brick



**11**

- 2x yellow 30-hole Technic axle
- 1x black 90-hole Technic axle
- 2x red pins (labeled 'A')

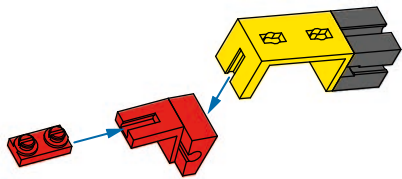
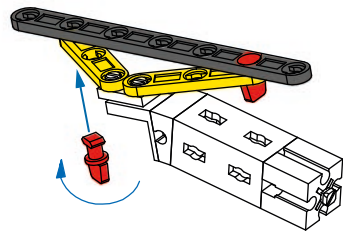

**12**

- 1x grey 2-hole Technic brick
- 1x red 1-hole Technic brick
- 1x yellow 1-hole Technic brick
- 1x red 1-hole Technic brick
- 1x red 2-hole Technic brick



**13**

- 2x yellow 30-hole Technic axle
- 1x black 90-hole Technic axle
- 2x red pins (labeled 'A')

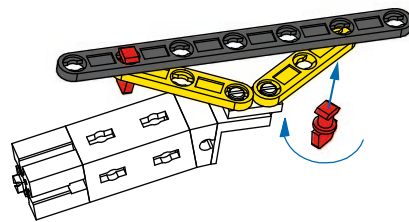

14

30 2 x

4 x

90 1 x

84,8 1 x

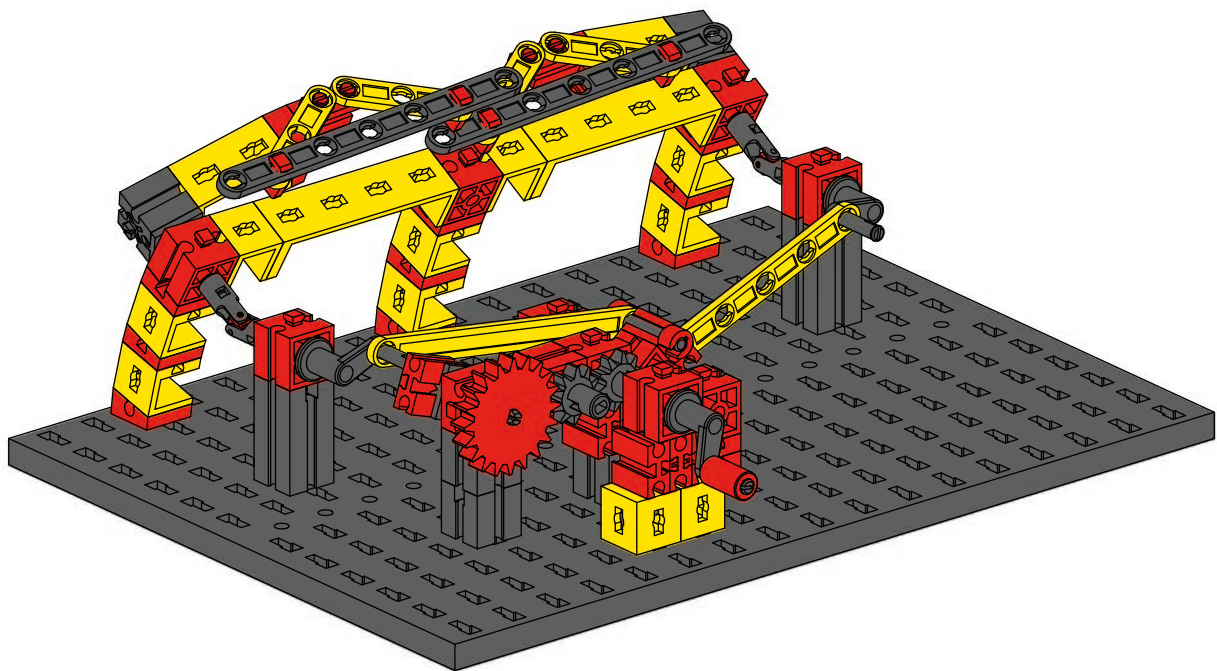
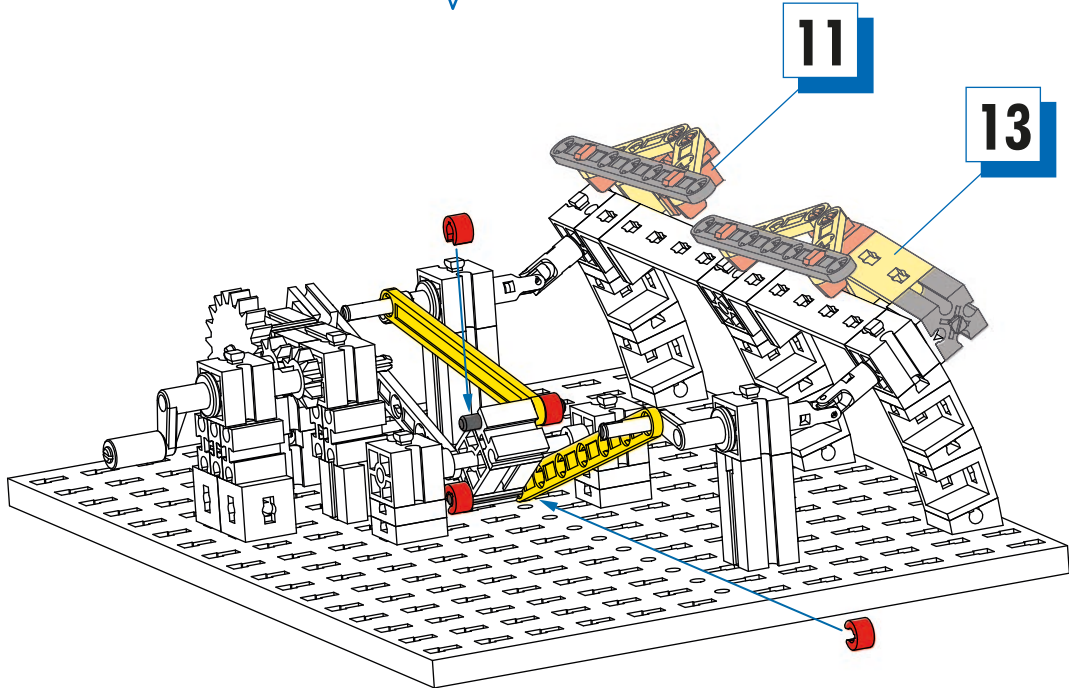

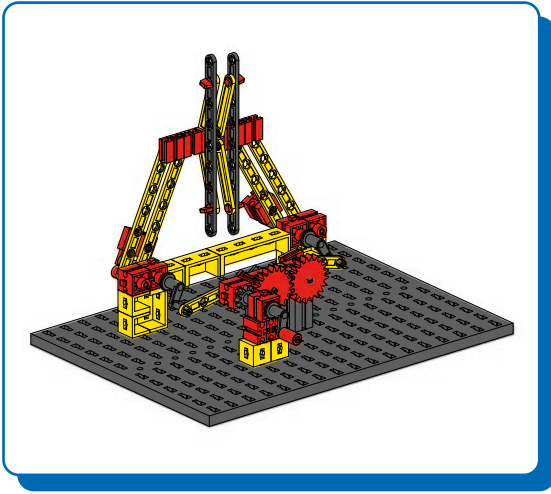

Scheibenwischer - parallel  
 Windshield wiper - parallel  
 Essuie-glace - parallèle  
 Ruitenwisser - parallel

Limpiaparabrisas - paralelo  
 Limpador de pára-brisas - paralelo  
 Tergicristalli - paralleli

Стеклоочиститель  
 ветрового стекла -  
 параллельно  
 平行式雨刮器

**1**

	1 x		2 x
	1 x		1 x

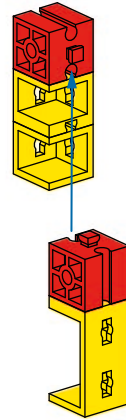

**2**

	1 x		2 x
	1 x		1 x

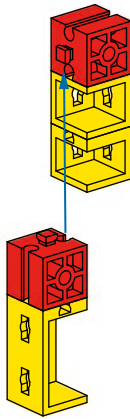

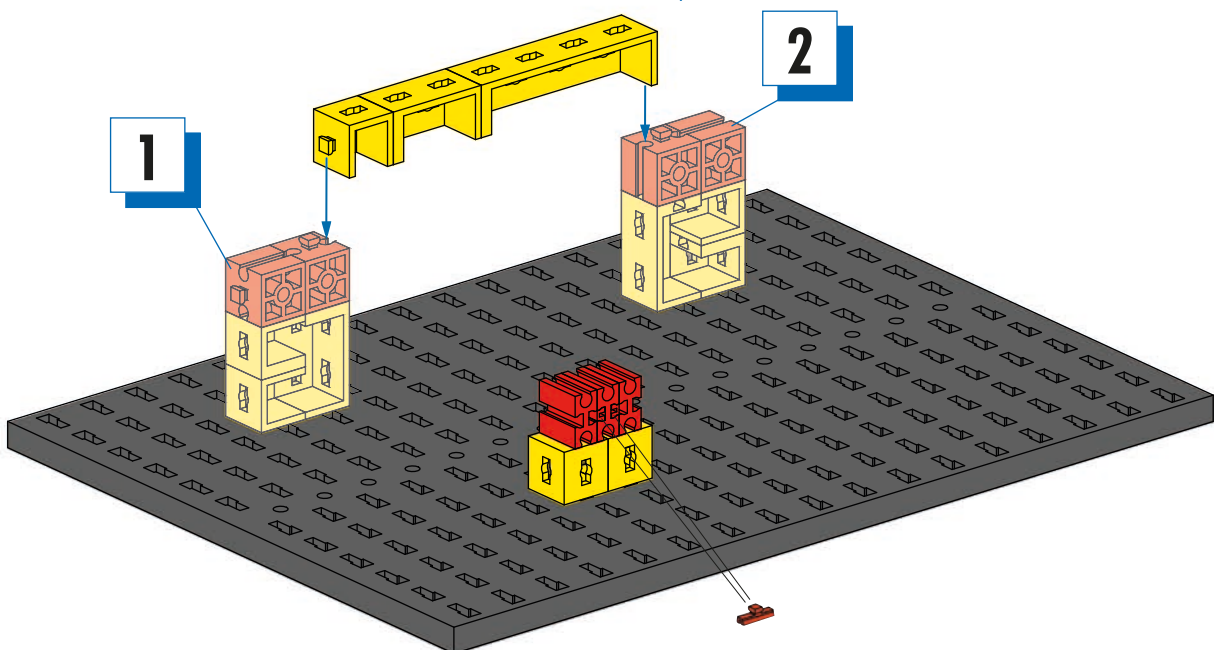

**3**

	2 x		3 x		1 x
	1 x		3 x		1 x

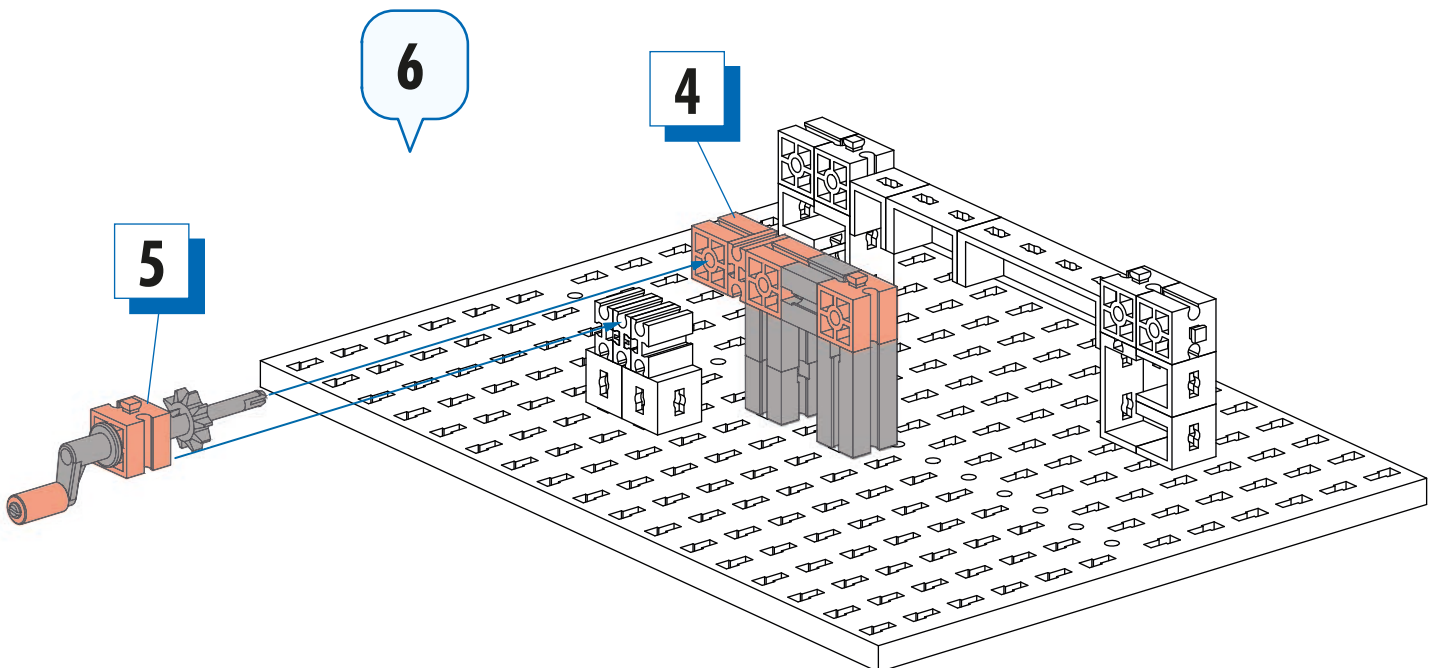
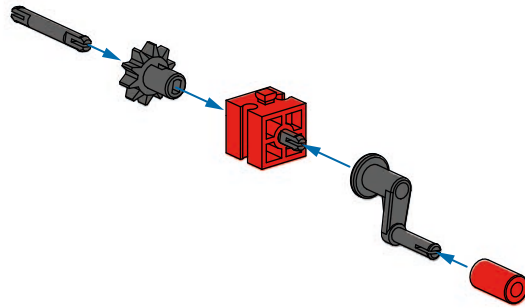
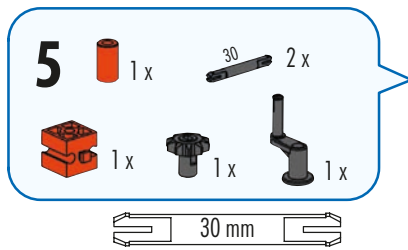
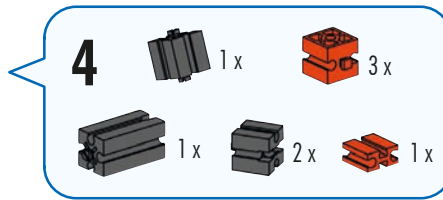
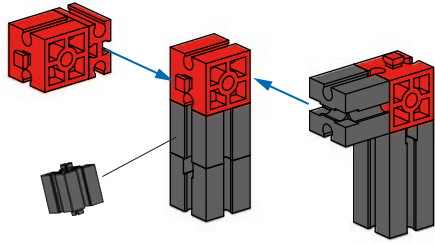

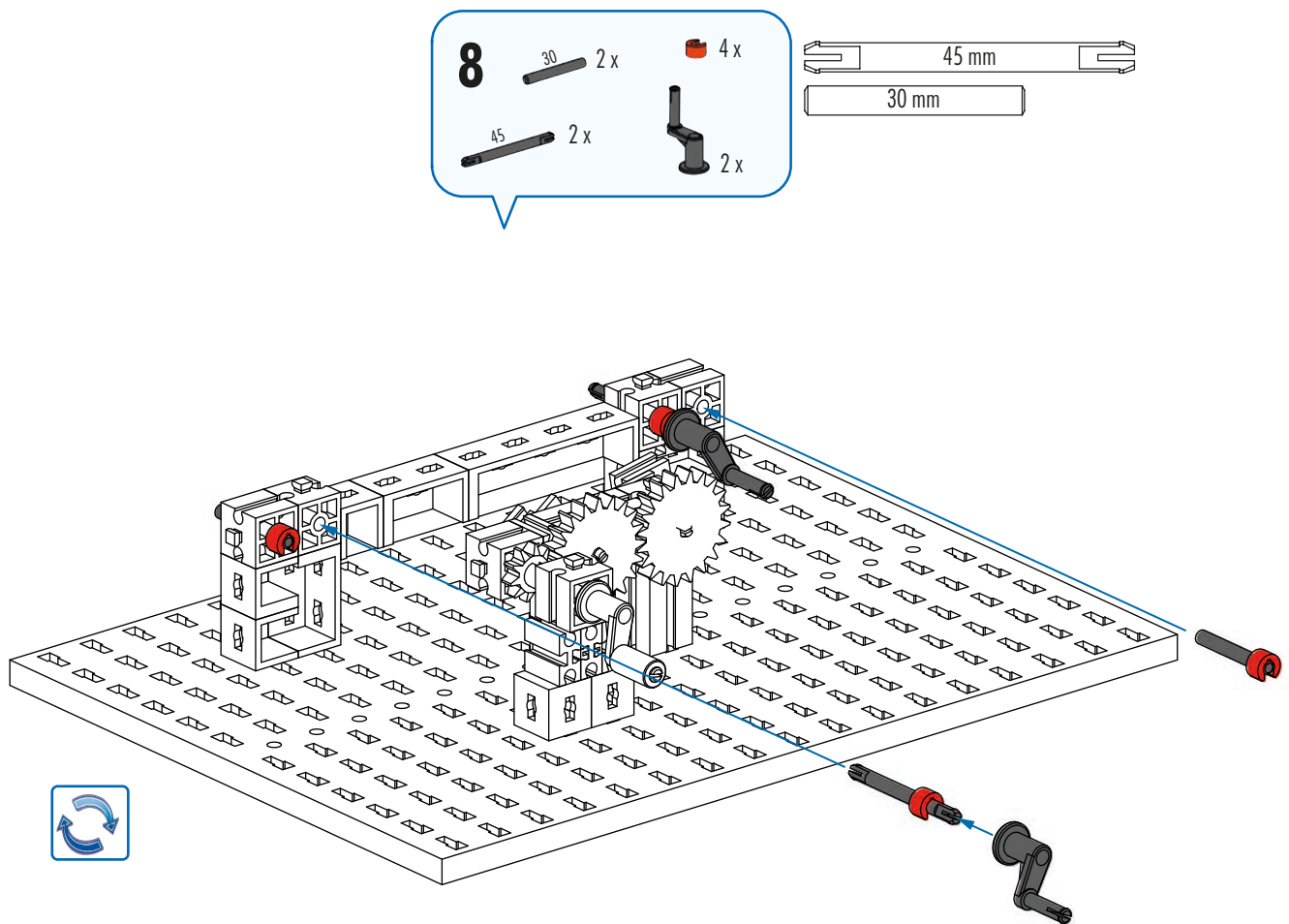
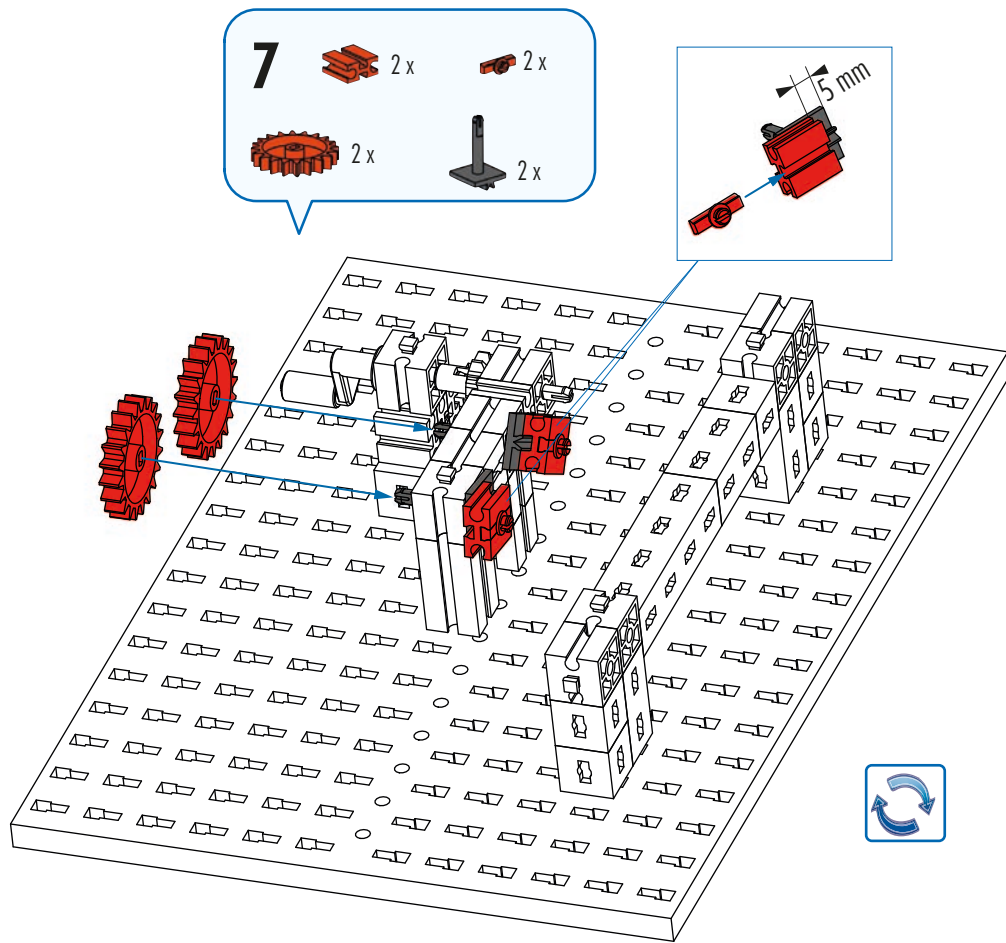





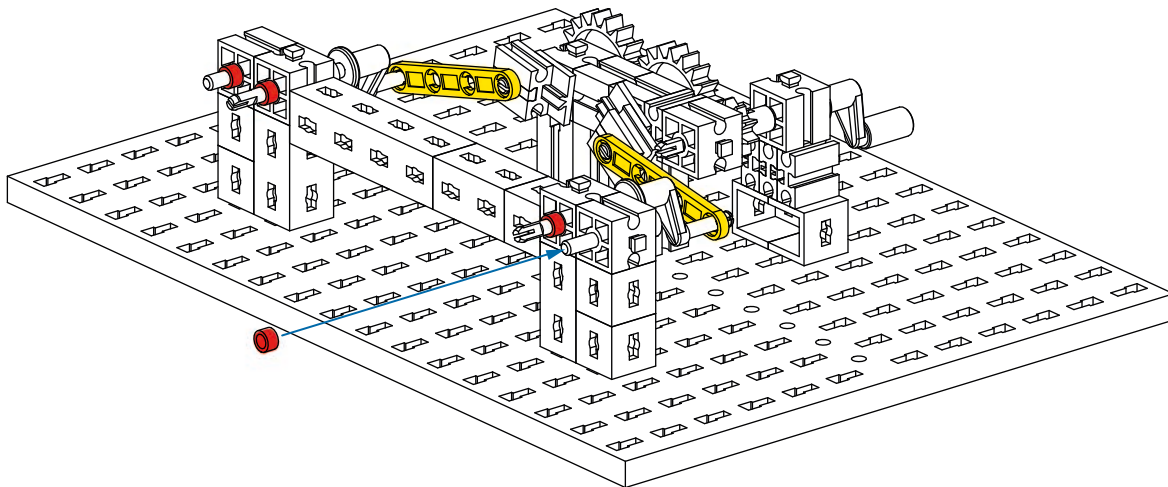

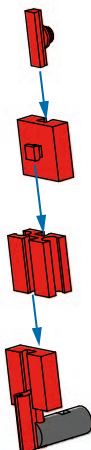

**9**  2 x  4 x







**2x**



**10**  2 x  2 x

 2 x  4 x  2 x



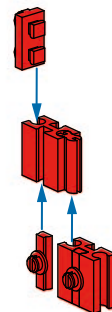

**11**  2 x  4 x

 4 x  2 x





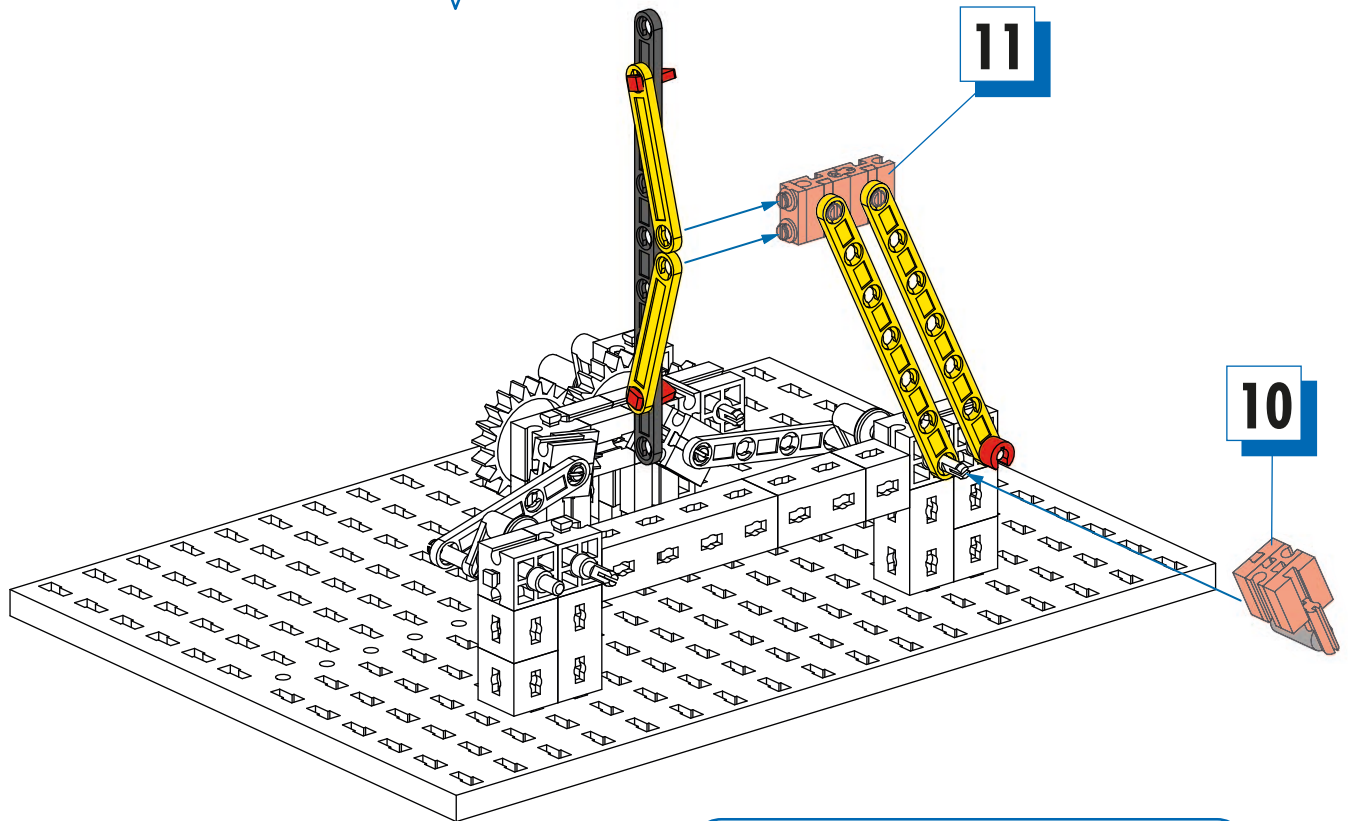

**2x**

**12**

-  2 x
-  1 x
-  1 x
-  2 x
-  2 x



**13**

-  2 x
-  1 x
-  1 x
-  2 x
-  2 x

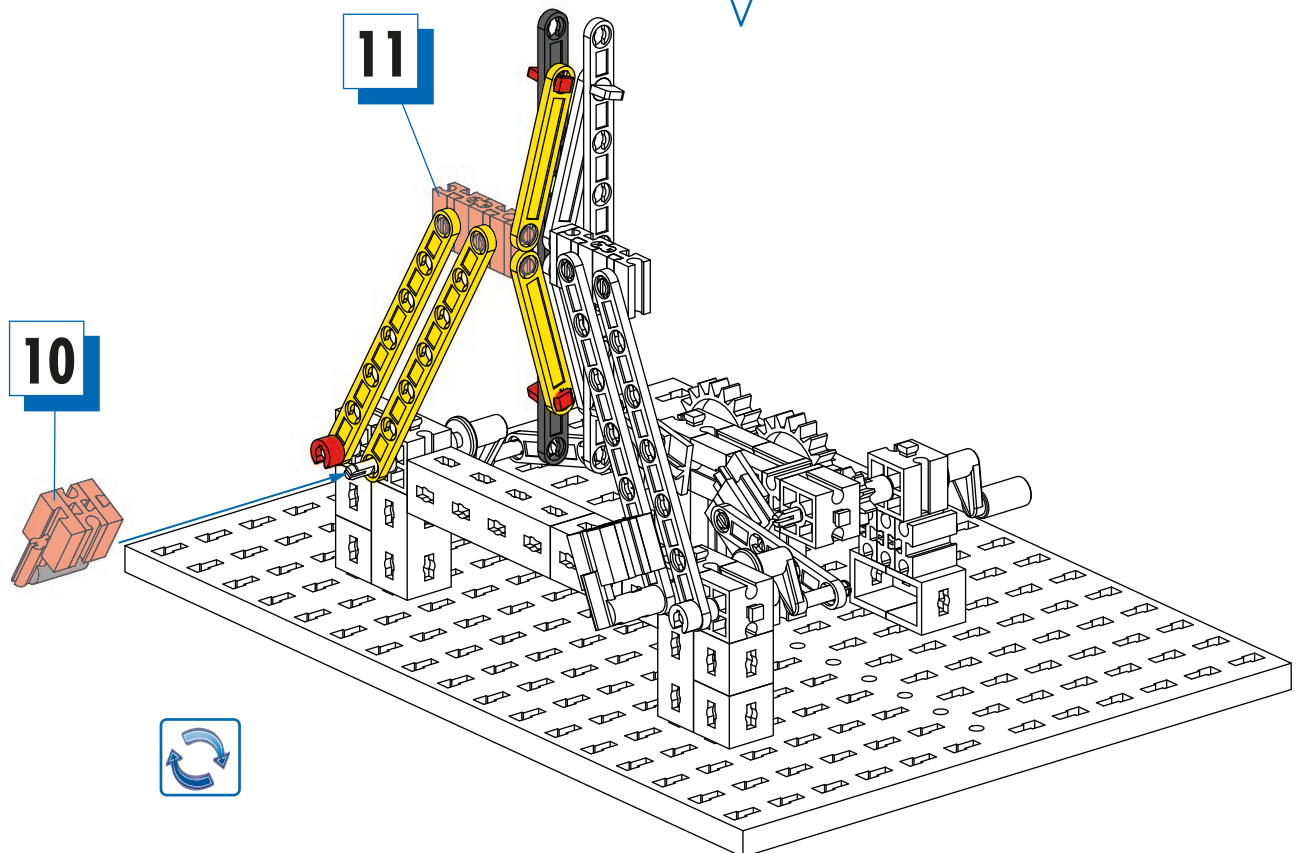





Exzenterpresse  
Eccentric press  
Presse à excentrique

Excentriche pers  
Prensa excéntrica  
Prensa excêntrica  
Pressa eccentrica

Эксцентрический  
пресс  
偏心压力机

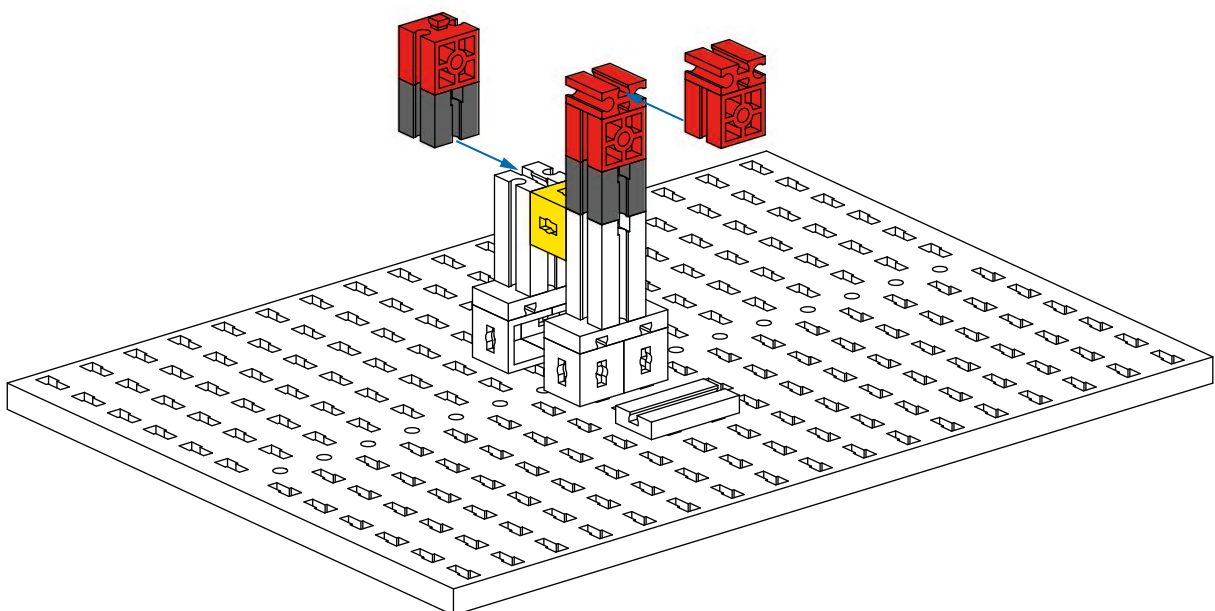
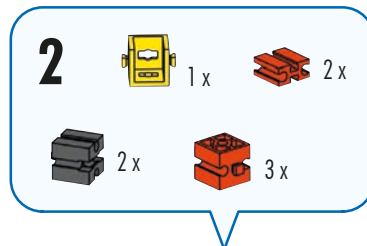
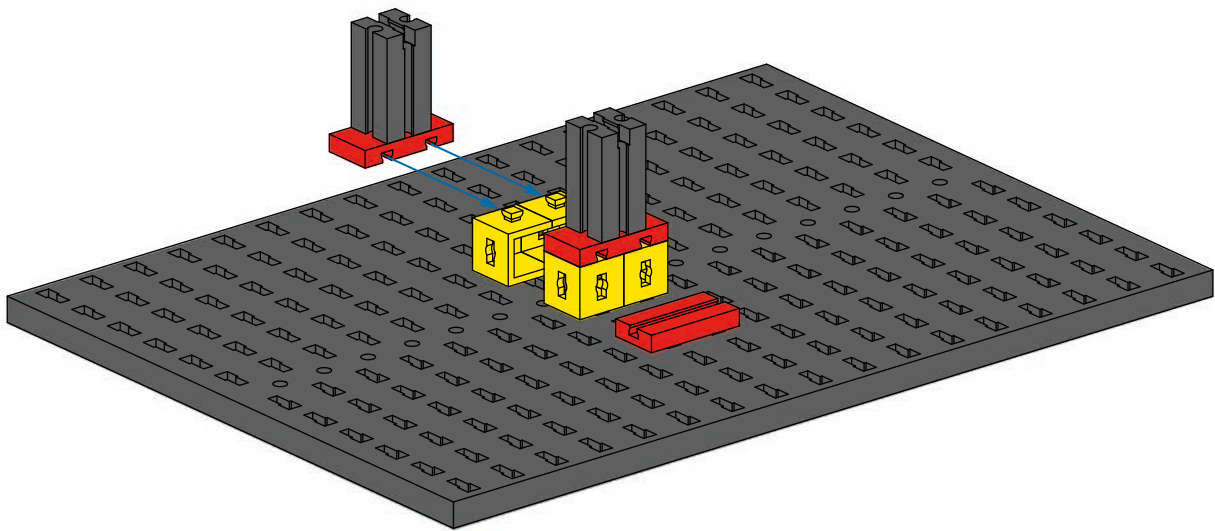
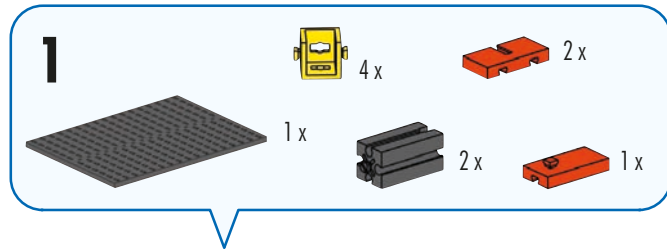
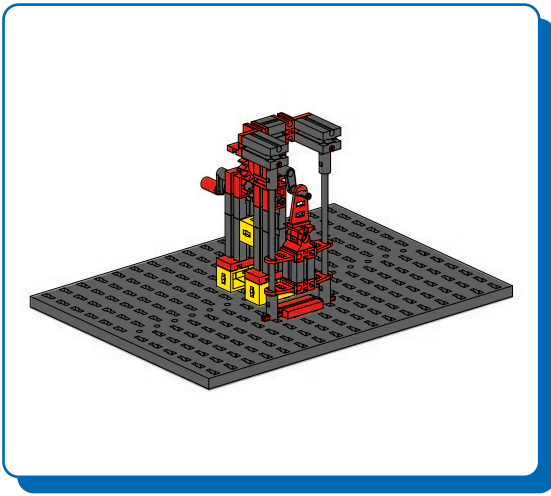





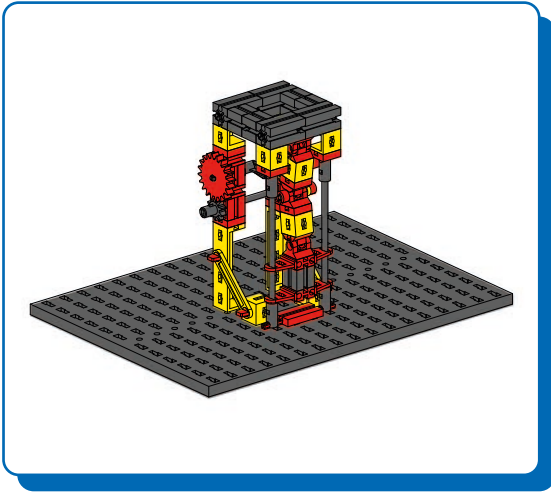

Kniehebelpresse  
Toggle press  
Presse à genouillère

Kniehebboompers  
Pulsar el botón  
Alternar a prensa  
Premere il pulsante

Тумблерное  
нажатие  
切换式压力机

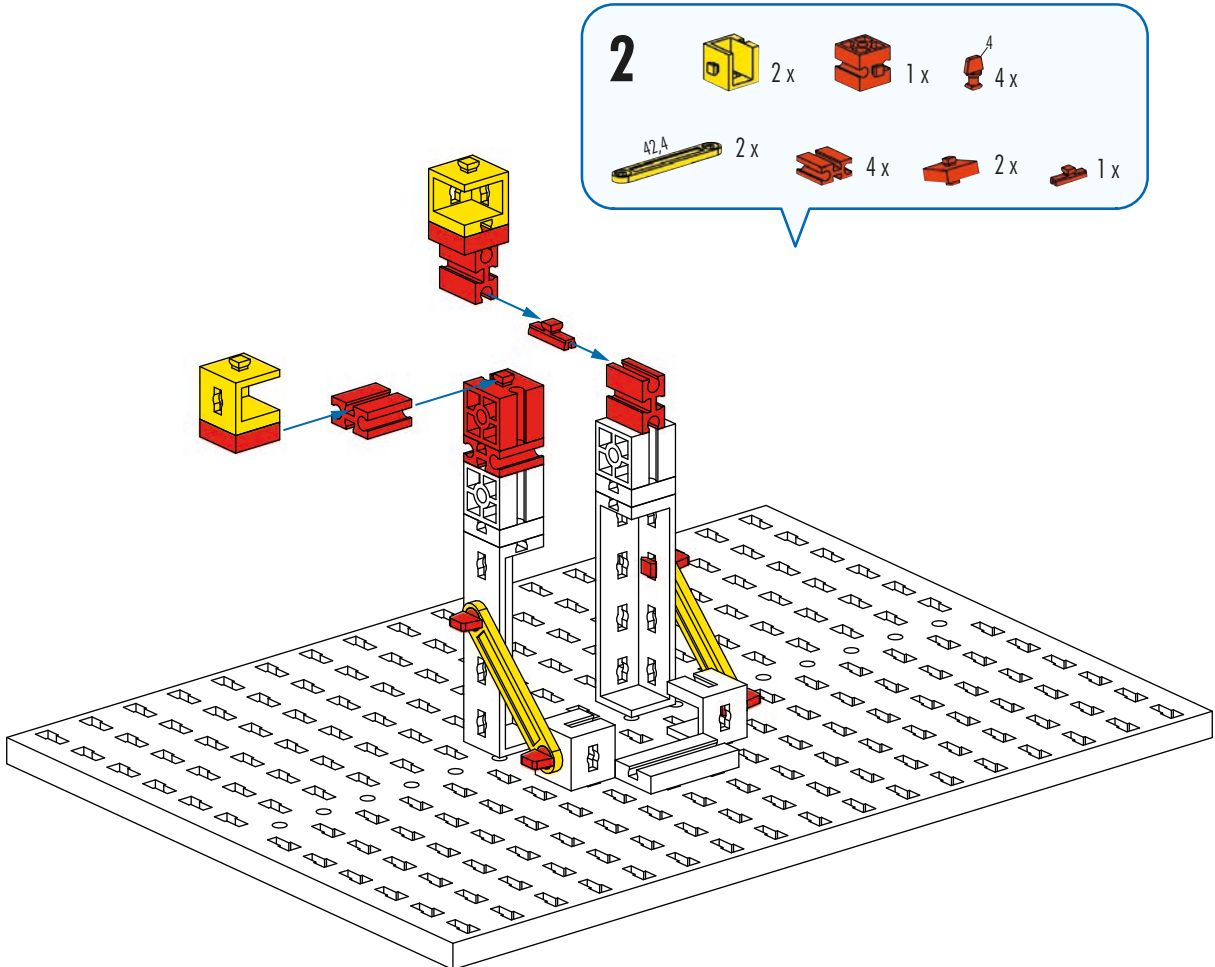
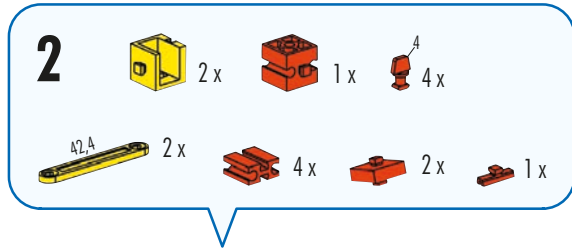
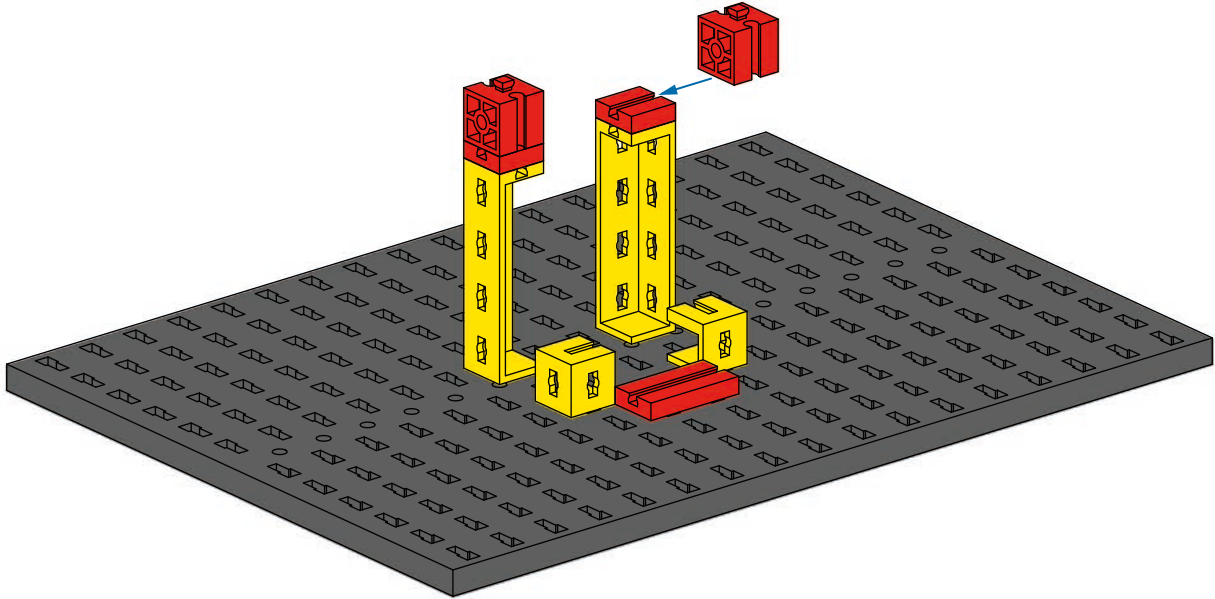
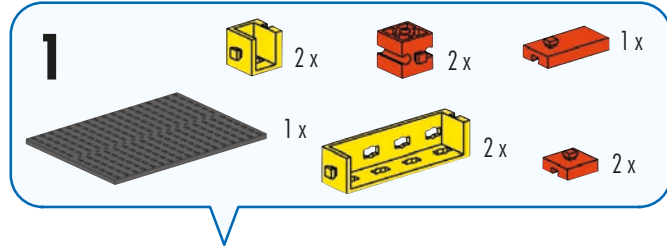

**3**

- 30 1x
- 75 1x
- 1x
- 2x
- 1x
- 1x

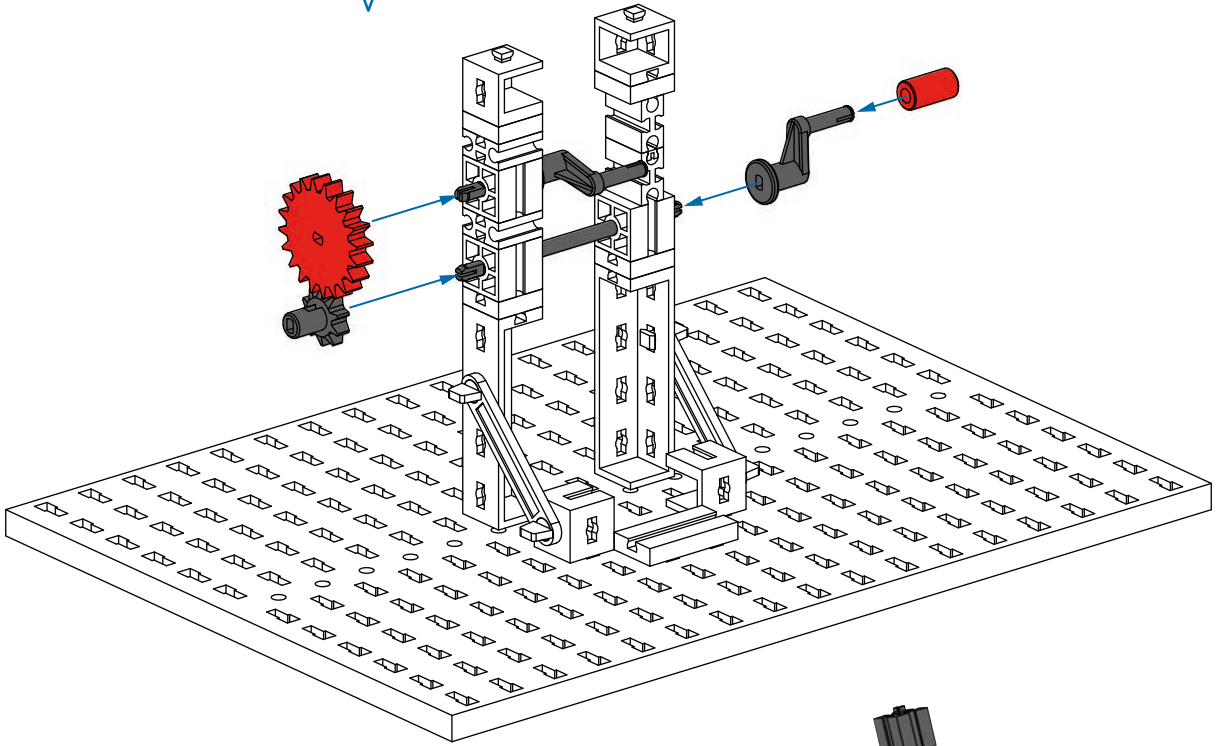
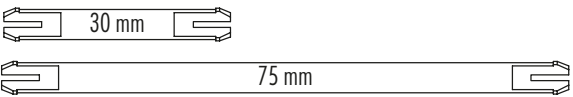

**4**

- 2x
- 4x
- 2x

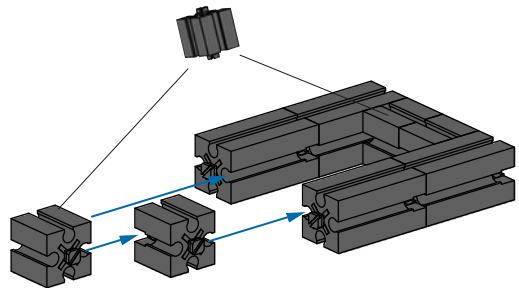

**4**

**5**

- 2x
- 1x
- 2x

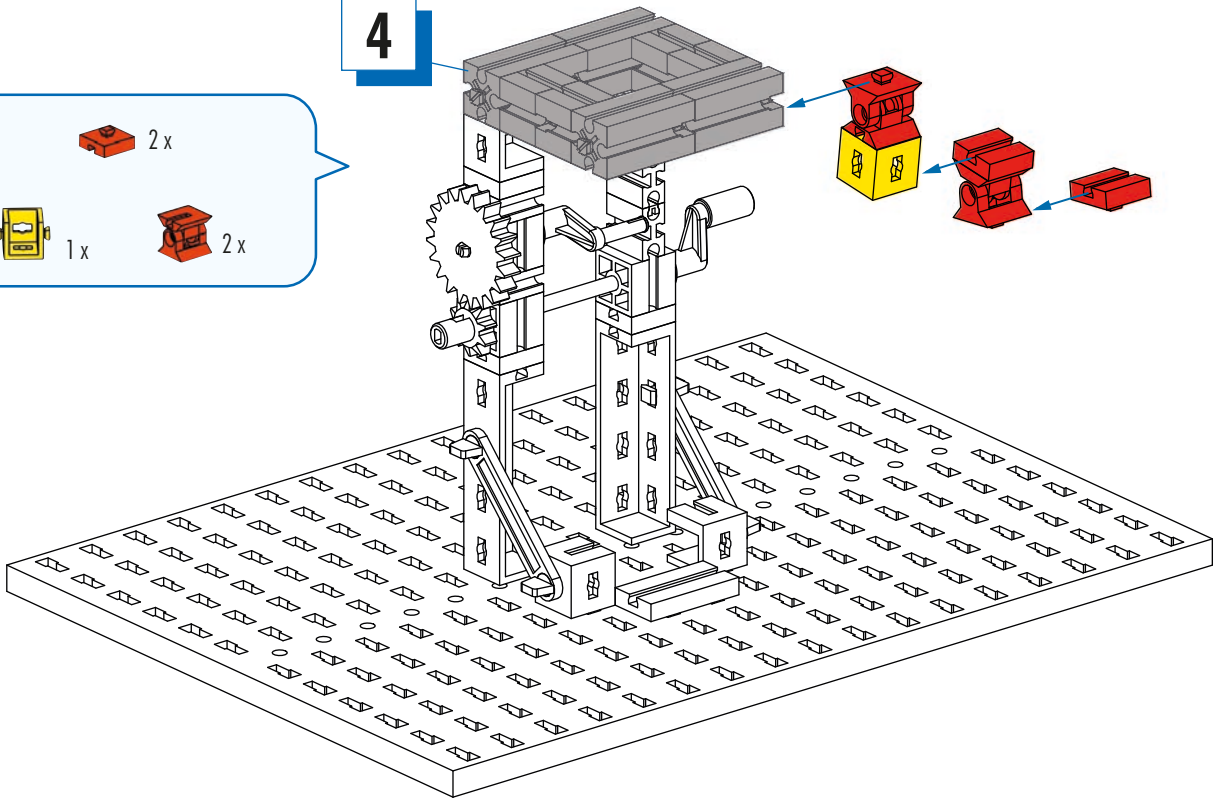

6



1 x



1 x



1 x

30 mm



1 x



2 x



2 x



2 x

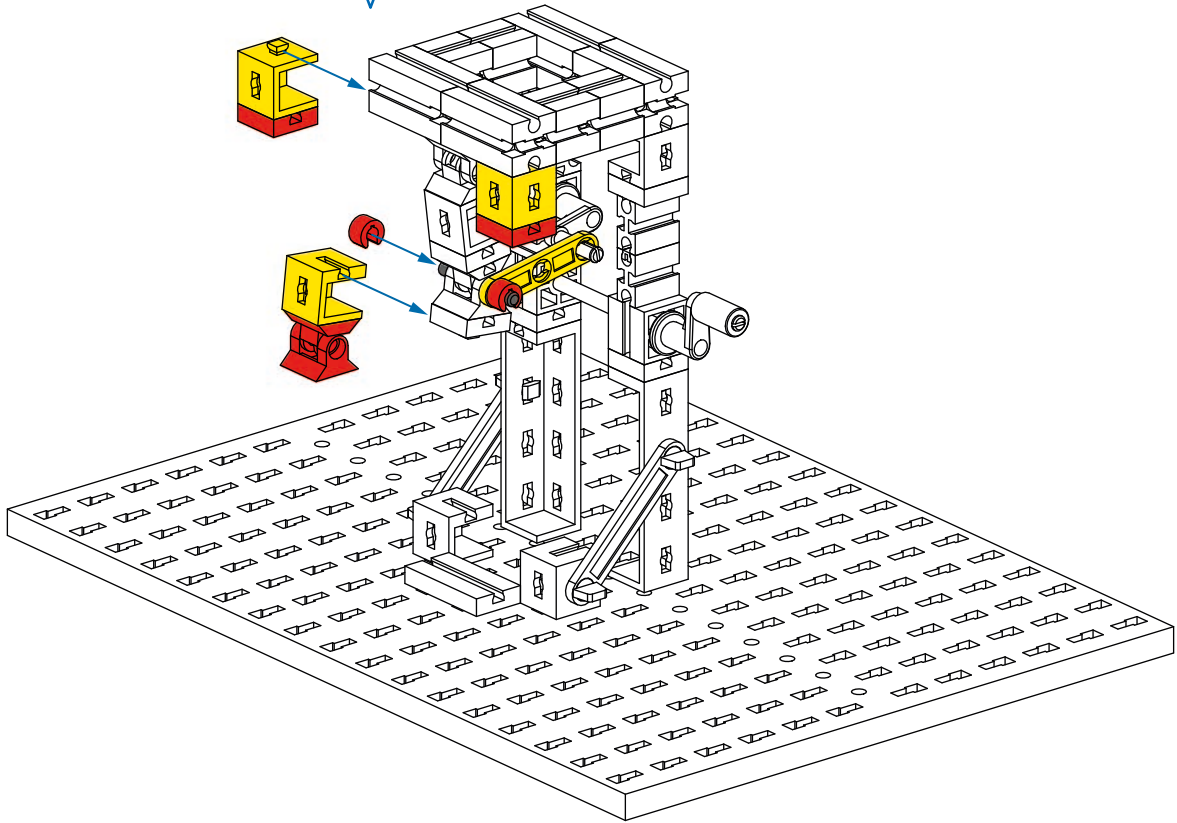

7



2 x



1 x



4 x

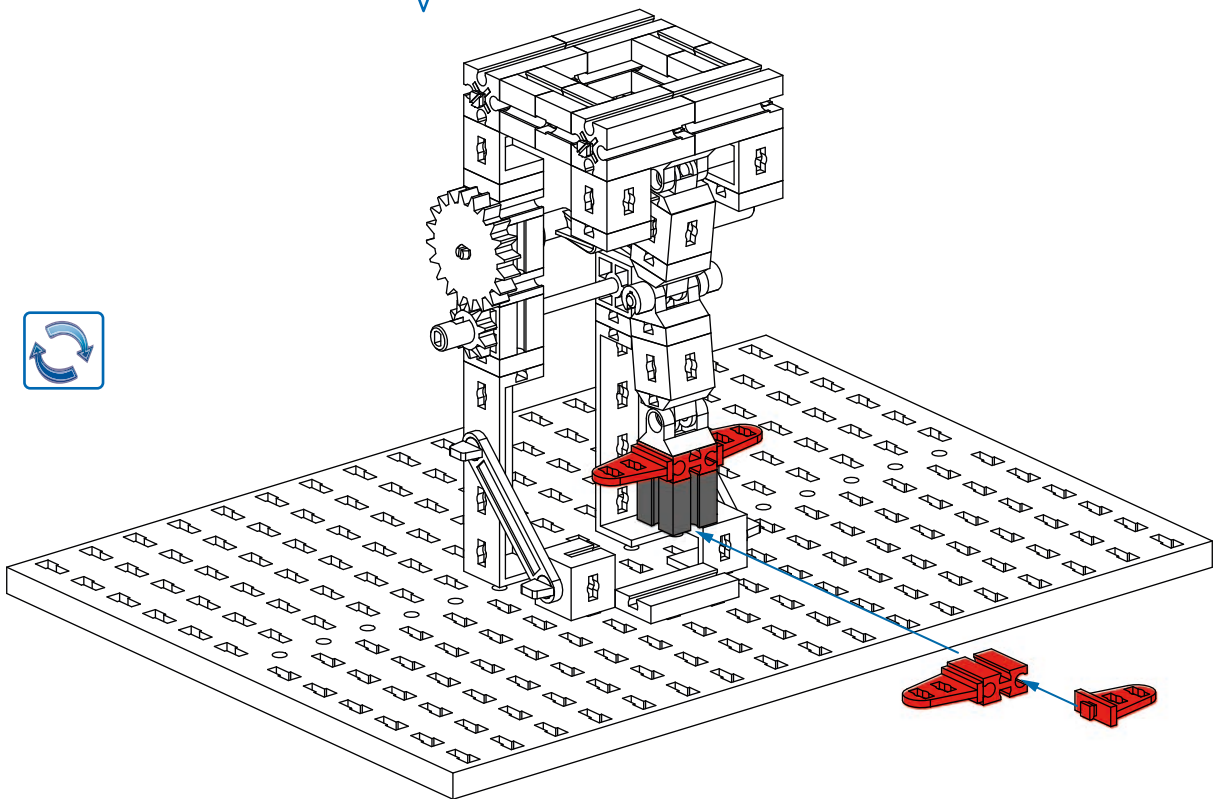

**8**

- 4 x [Grey Technic Pin]
- 2 x [Red Technic Pin]
- 90 [Grey Technic Pin]

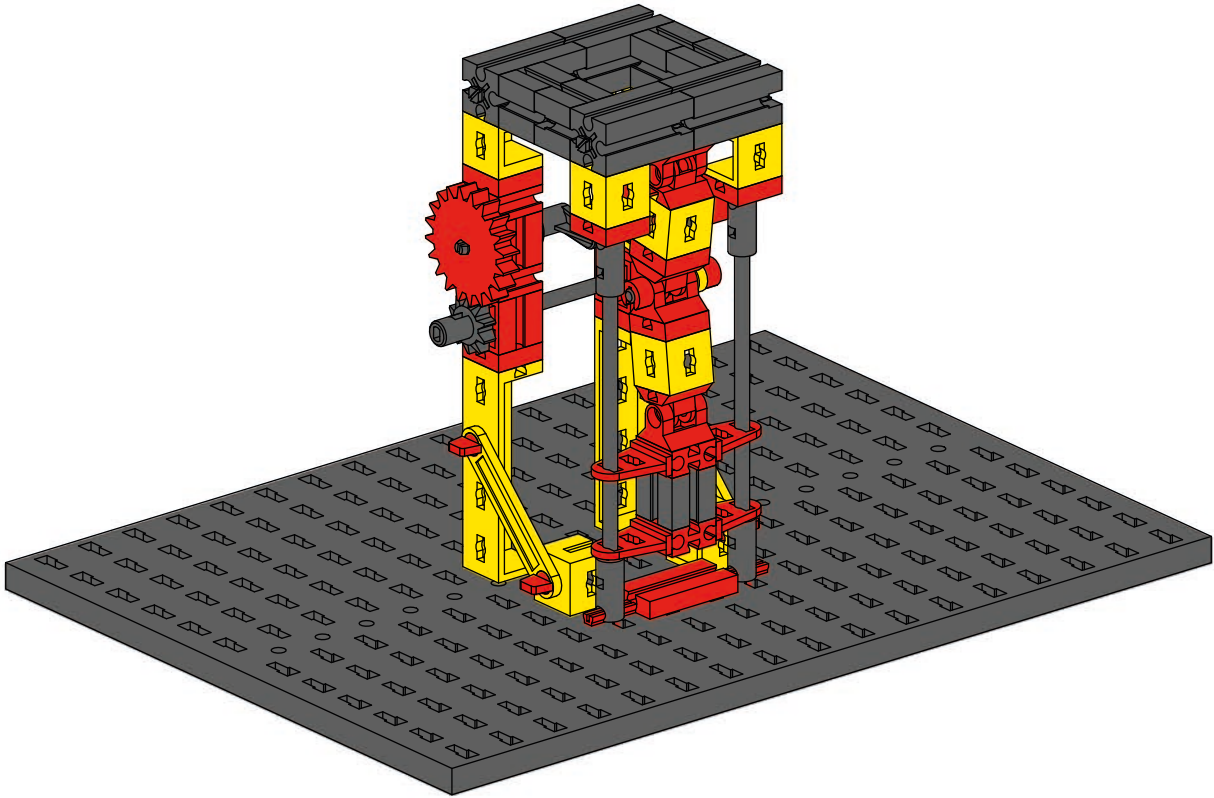
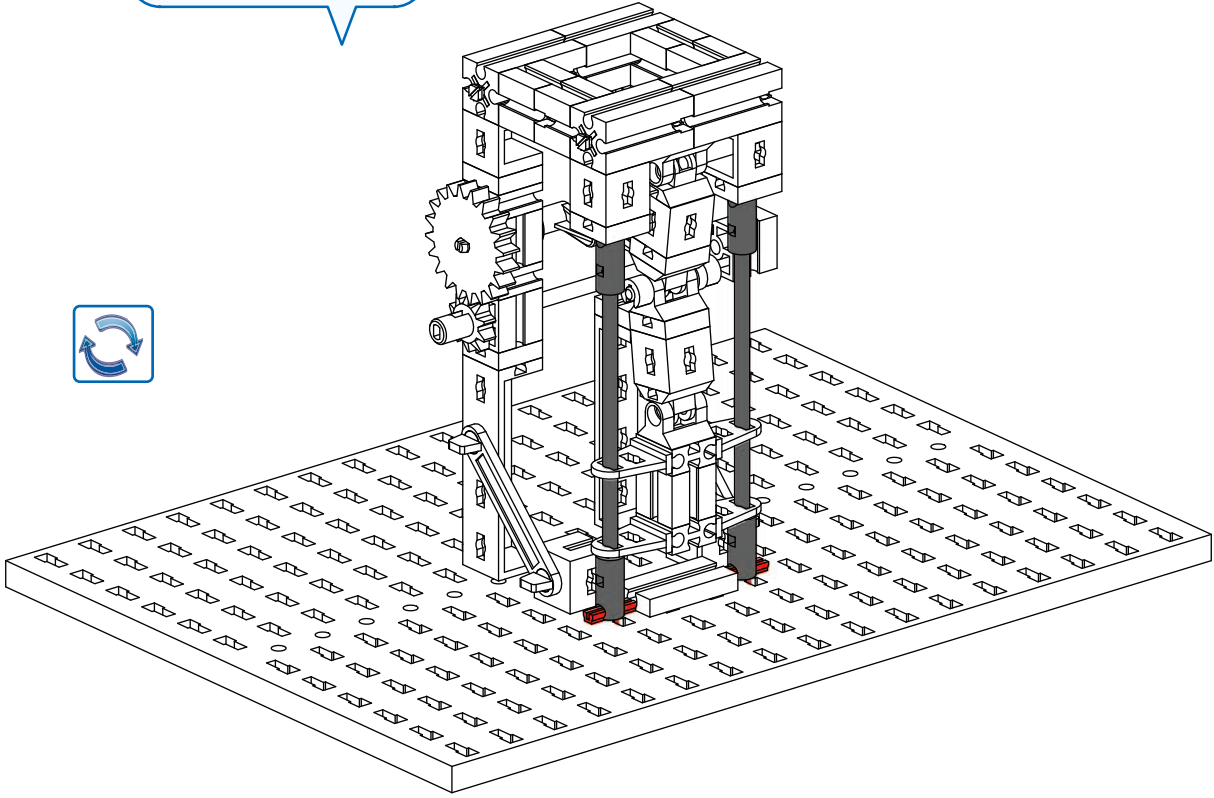
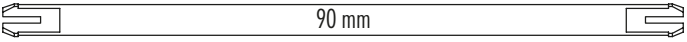

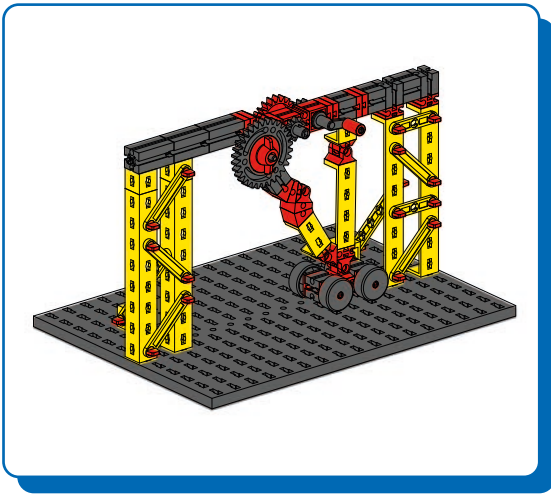

Kniegelenk mit Überstreckung  
 Knee joint with hyperextension  
 Articulation du genou avec hyperextension

Kniegewricht met hyperextensie  
 Articulación de la rodilla con hiperextensión  
 Joelho articulado com hiperextensão

Articolazione del ginocchio con iperestensione  
 Коленный сустав при гиперэкстензии  
 膝关节伸展器

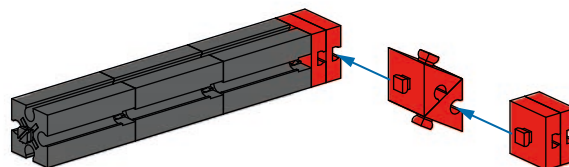
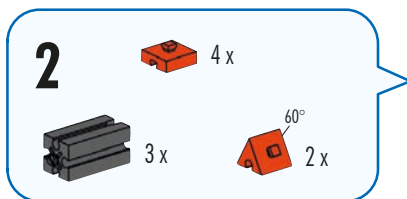
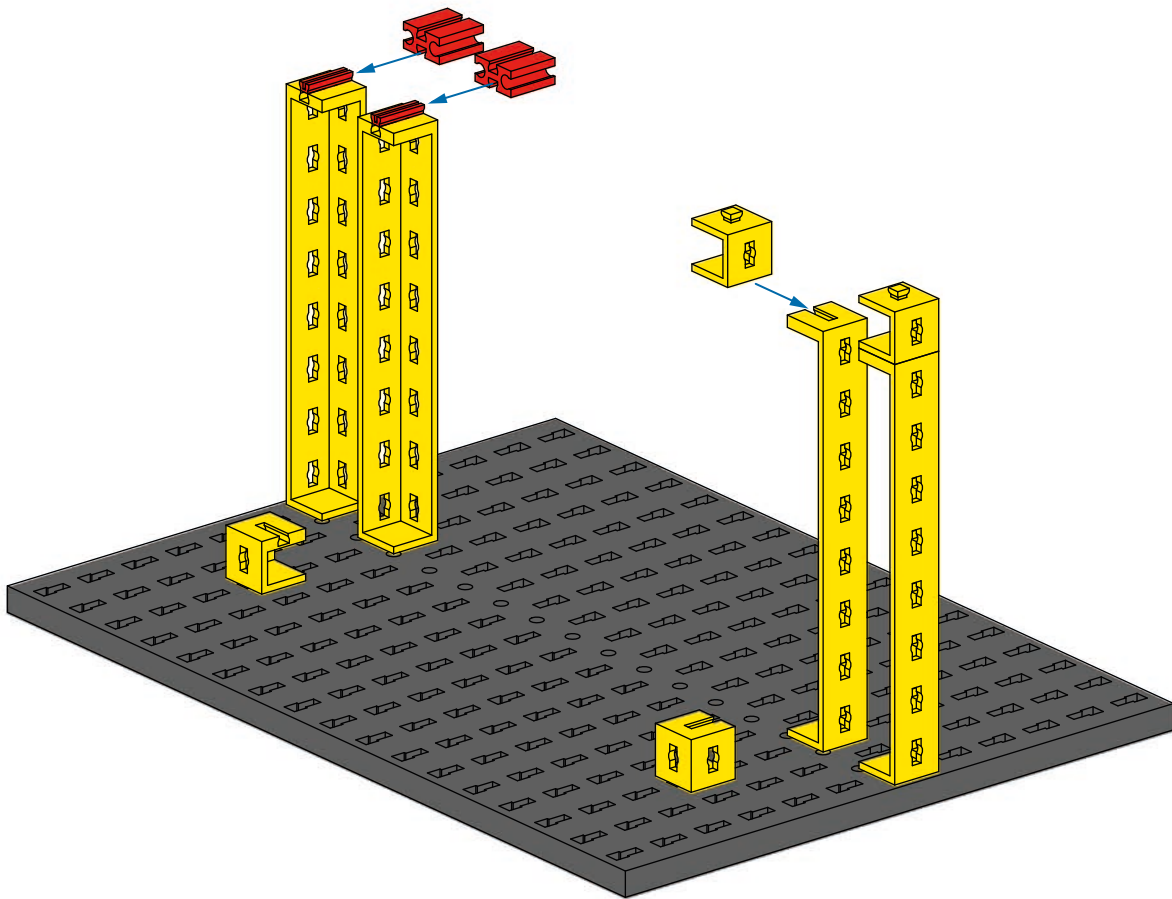
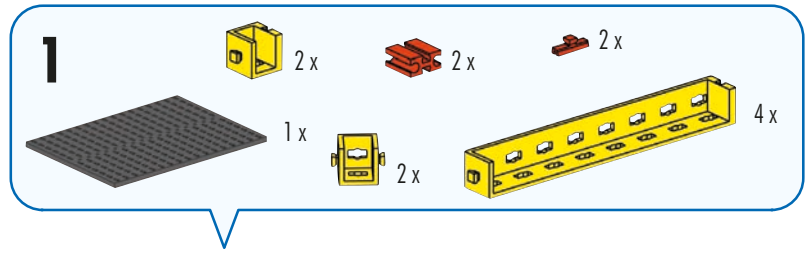



**3**

- 1x [Black 1x3 Technic Brick]
- 4x [Red 1x2 Technic Brick]
- 1x [Yellow 1x2 Technic Brick]
- 2x [Red 1x2 Technic Brick with Studs]
- 1x [Red 1x2 Technic Brick with Studs]

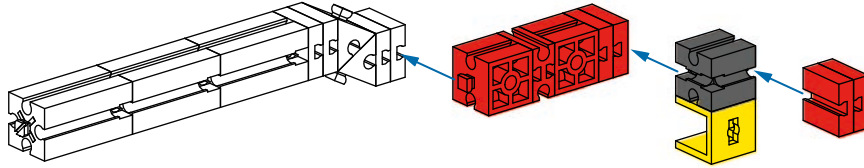

**4**

- 3x [Black 1x3 Technic Brick]
- 4x [Red 1x2 Technic Pin]
- 1x [Black 1x3 Technic Brick]
- 2x [Yellow Technic Beam 75]

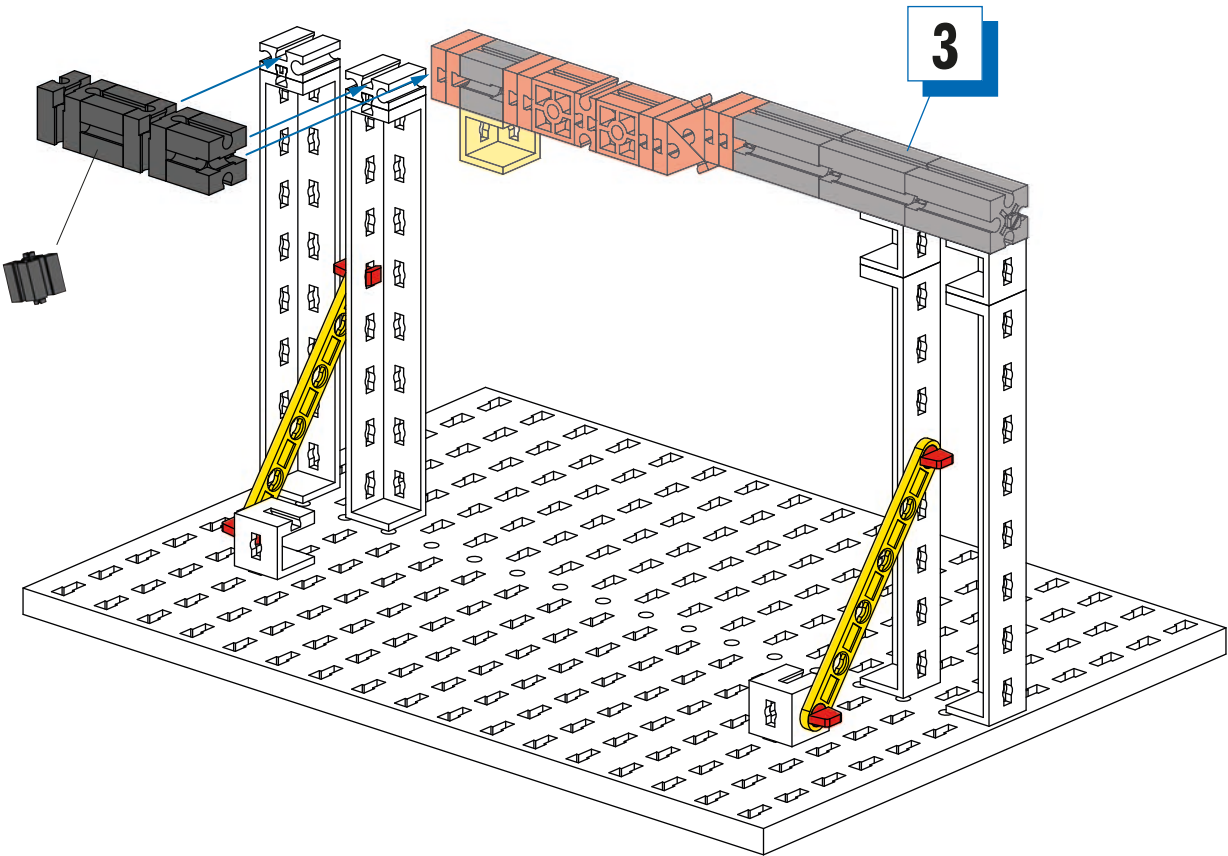

**5**

- 2x [Black 1x3 Technic Brick]
- 4x [Red 1x2 Technic Pin]
- 2x [Red 1x2 Technic Brick]
- 1x [Red 1x2 Technic Brick with Studs]
- 1x [Red 1x2 Technic Brick with Studs]

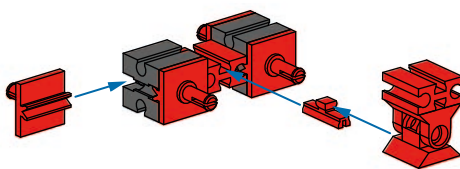

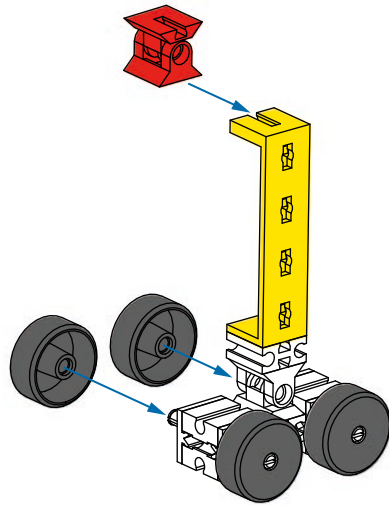

**6**

- 4 x
- 1 x
- 1 x

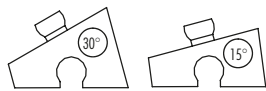

**7**

- 3 x
- 2 x
- 1 x
- 1 x
- 2 x
- 1 x

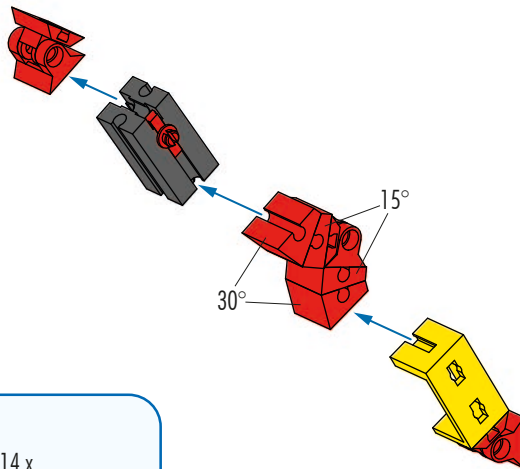

**8**

- 14 x
- 5 x
- 2 x

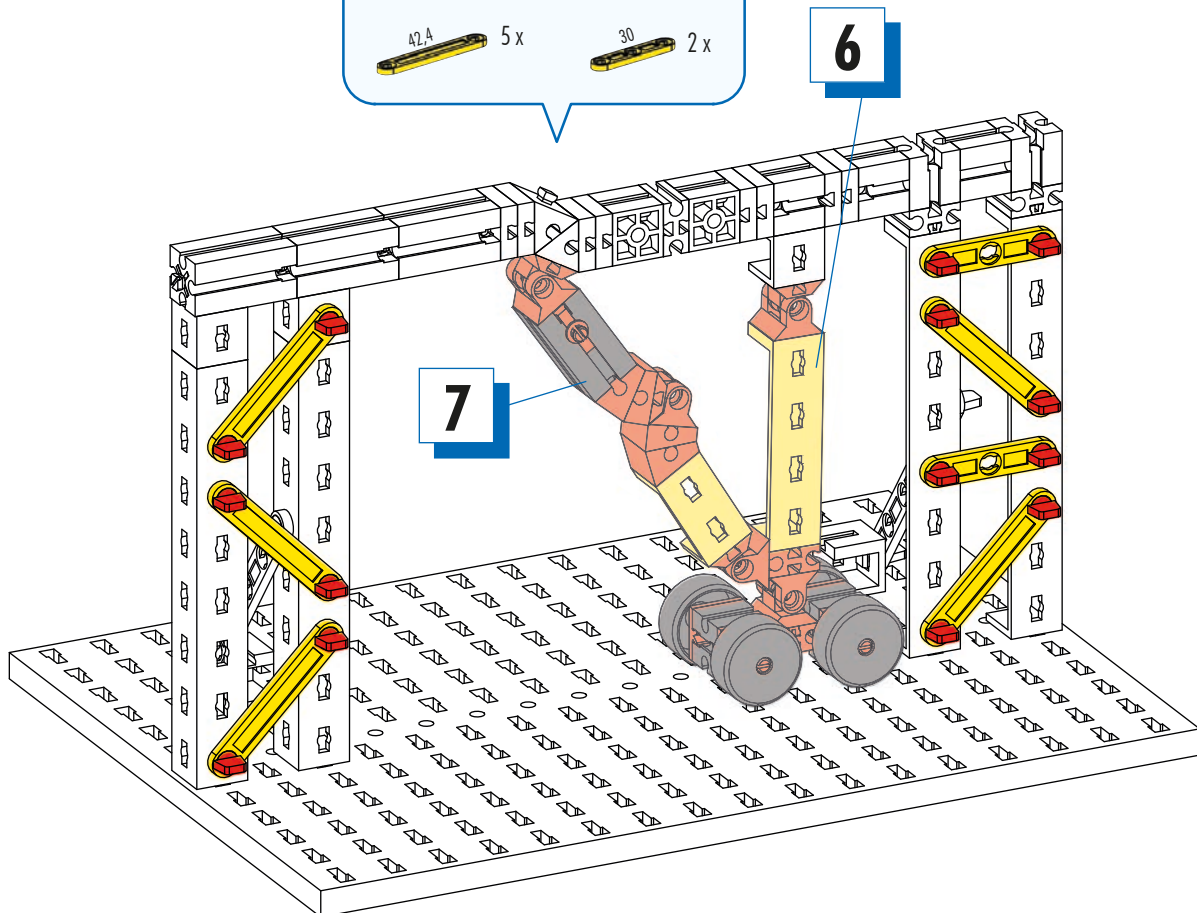

**9**

- 2 x [Black Pin]
- 1 x [Red Gear 24]
- 1 x [Red Pin]
- 1 x [Red Pin]
- 1 x [Red Pin]
- 1 x [Grey Gear 40]
- 1 x [Black T-shaped Pin]
- 1 x [Grey Axle 40]
- 2 x [Grey Axle 30]
- 1 x [Red Pin]

40 mm

30 mm

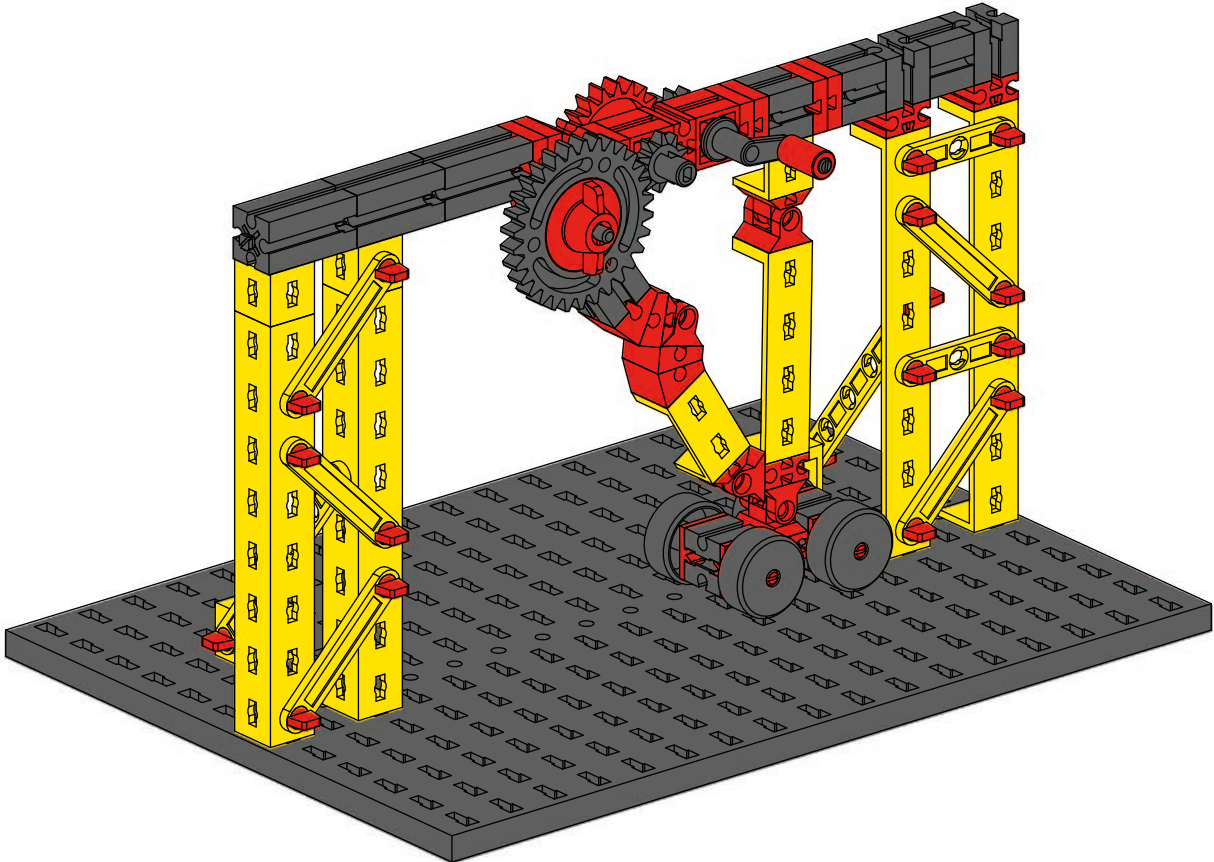
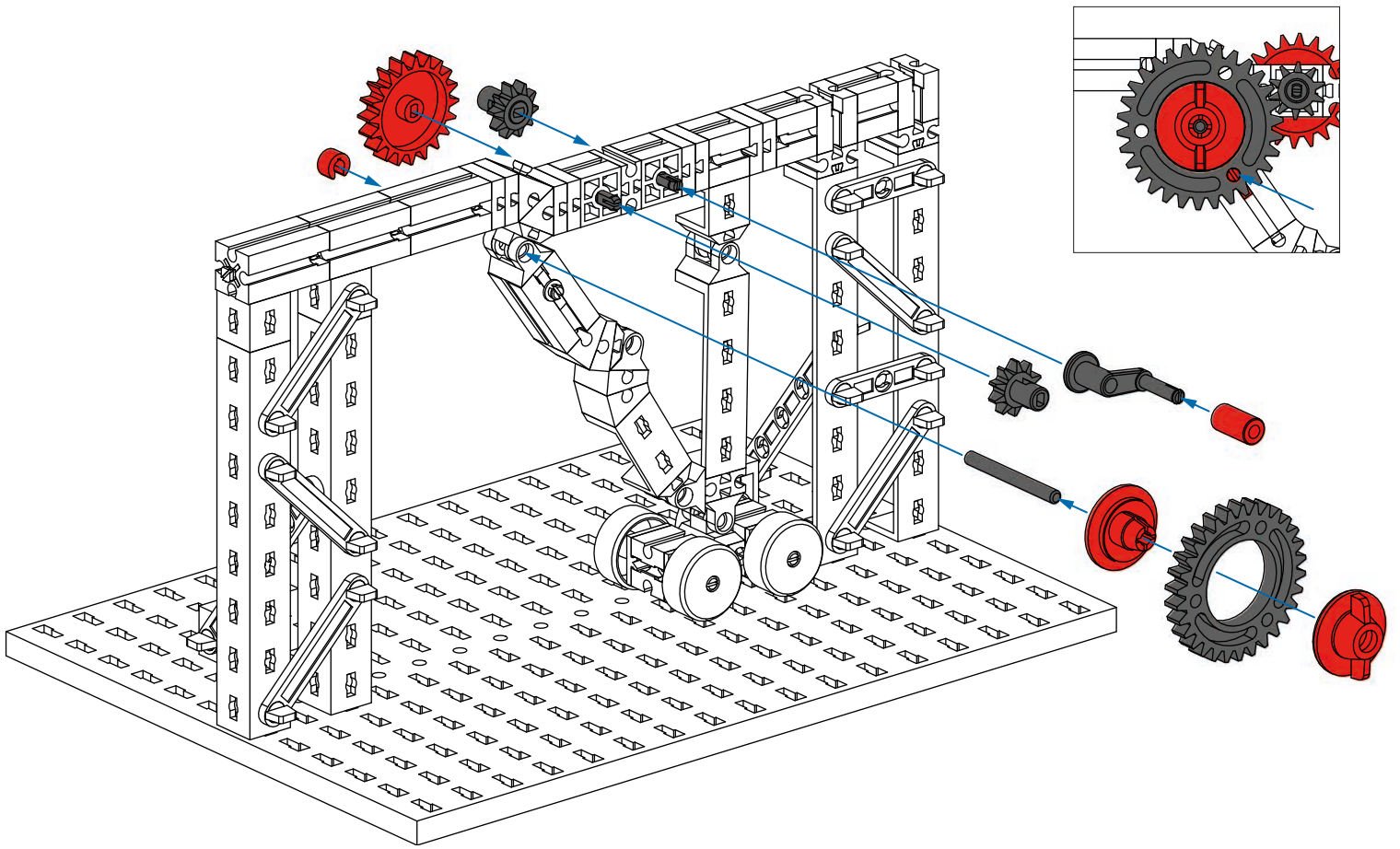



Zählwerk  
Counter  
Compteur

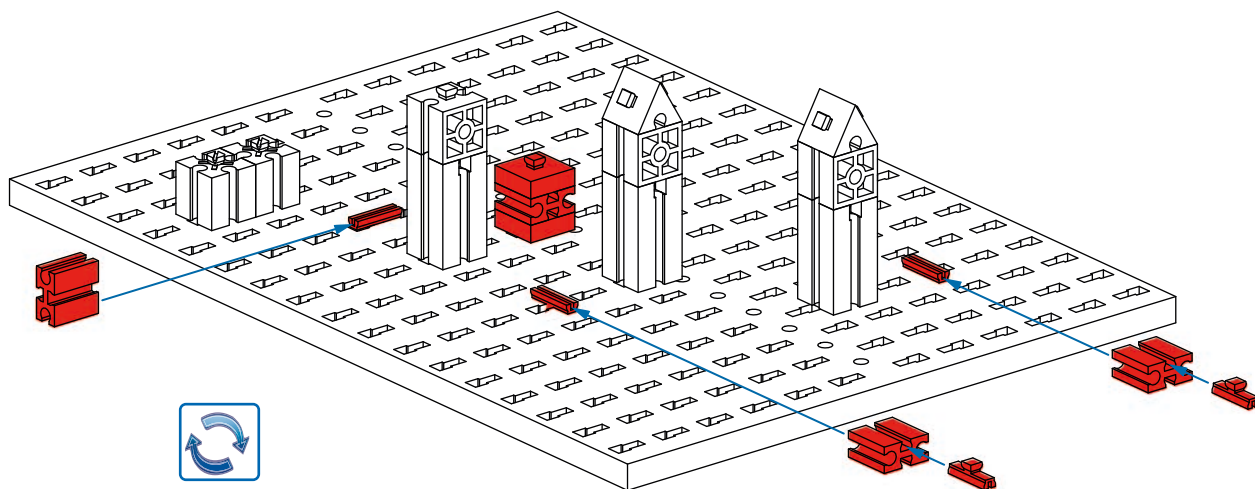
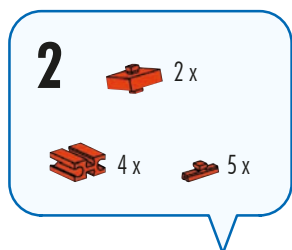
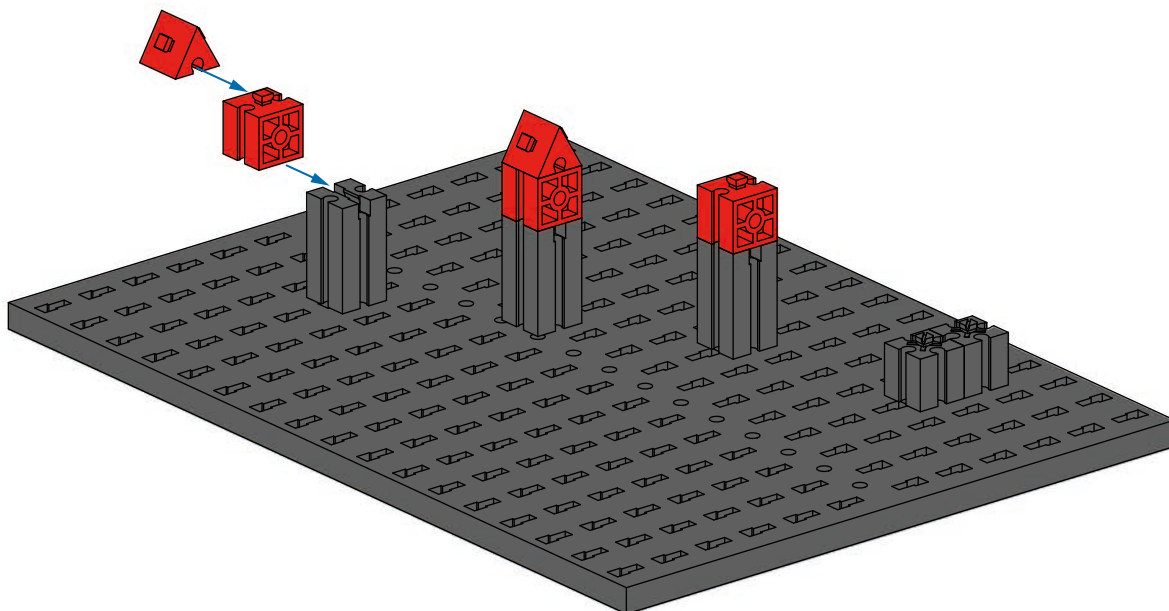
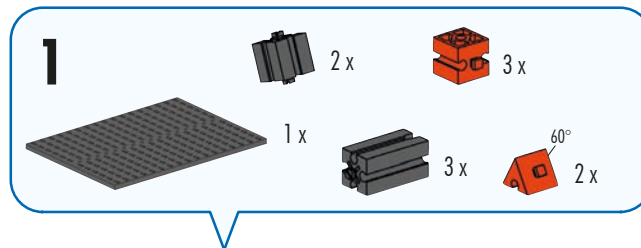
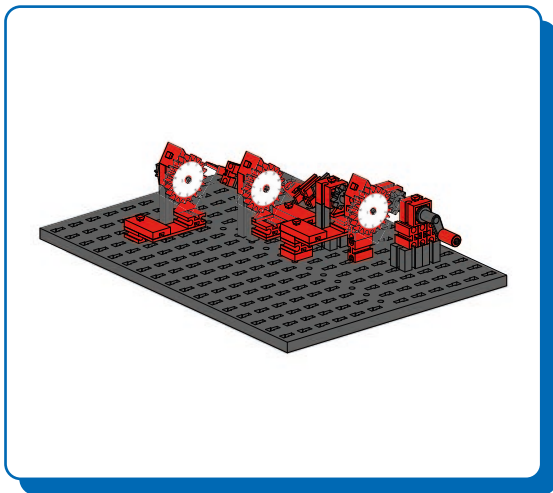

Telwerk  
Contador  
Contador

Contatore  
Счетчик  
计数器





**3**

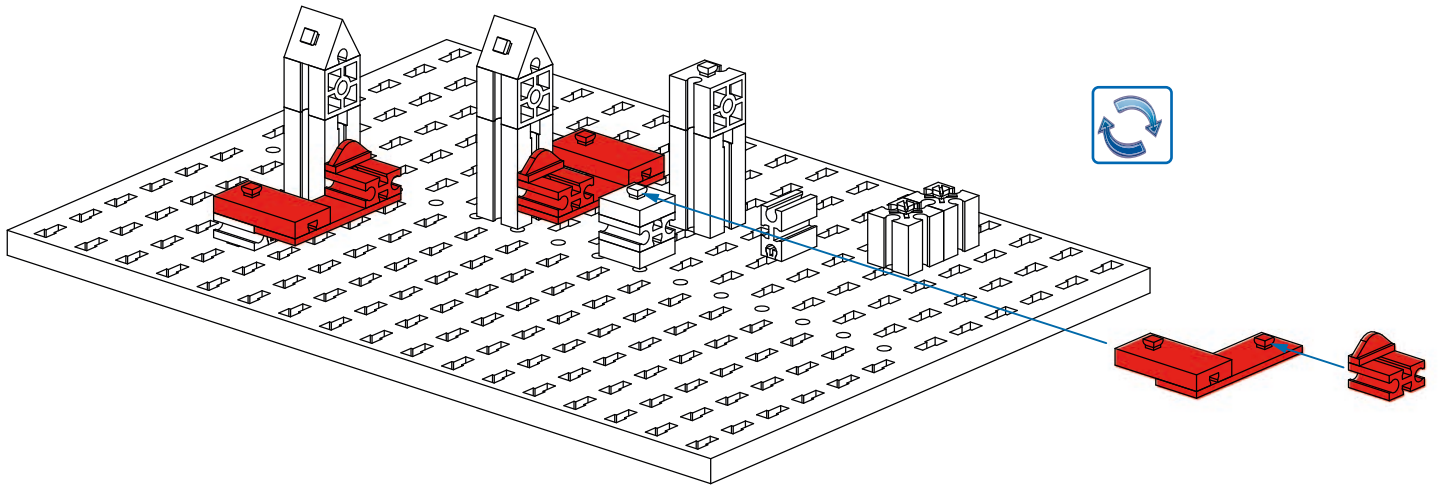

3x  3x  3x

3x  3x 



**4**

2x  2x 

3x  2x 

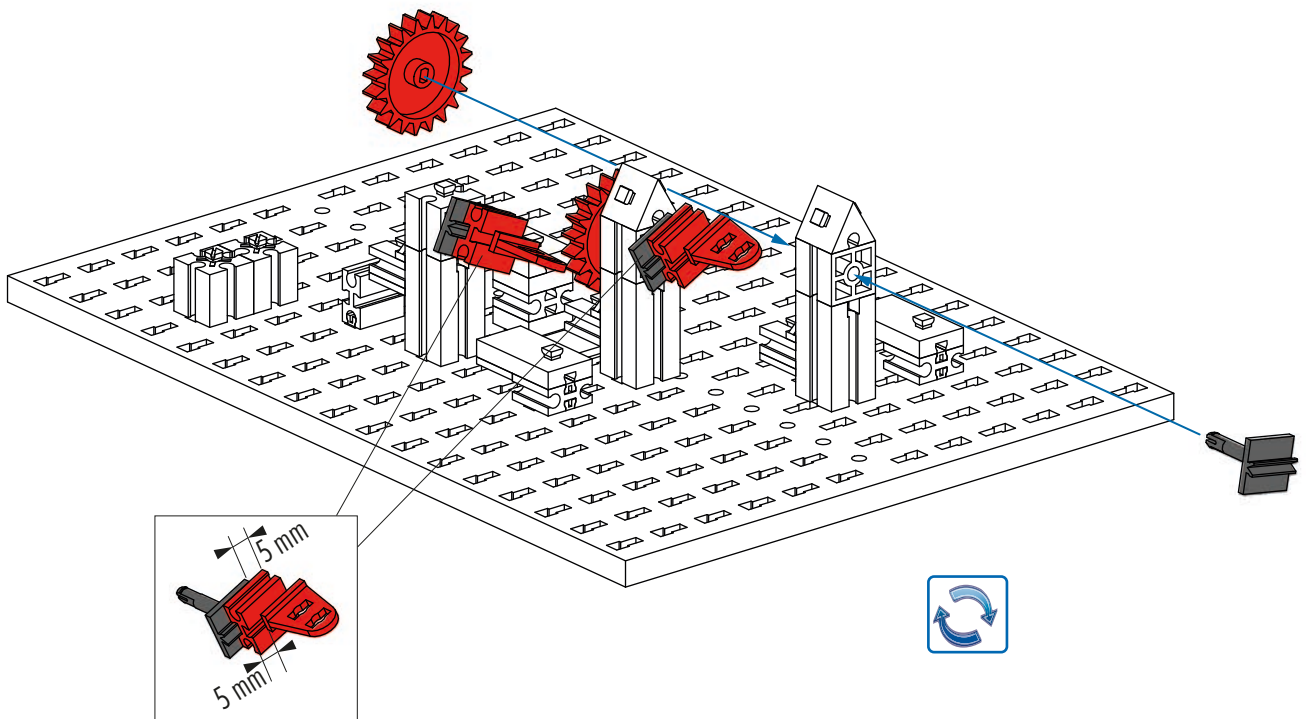

**5**

- 3x
- 5x
- 5x
- 1x

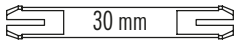
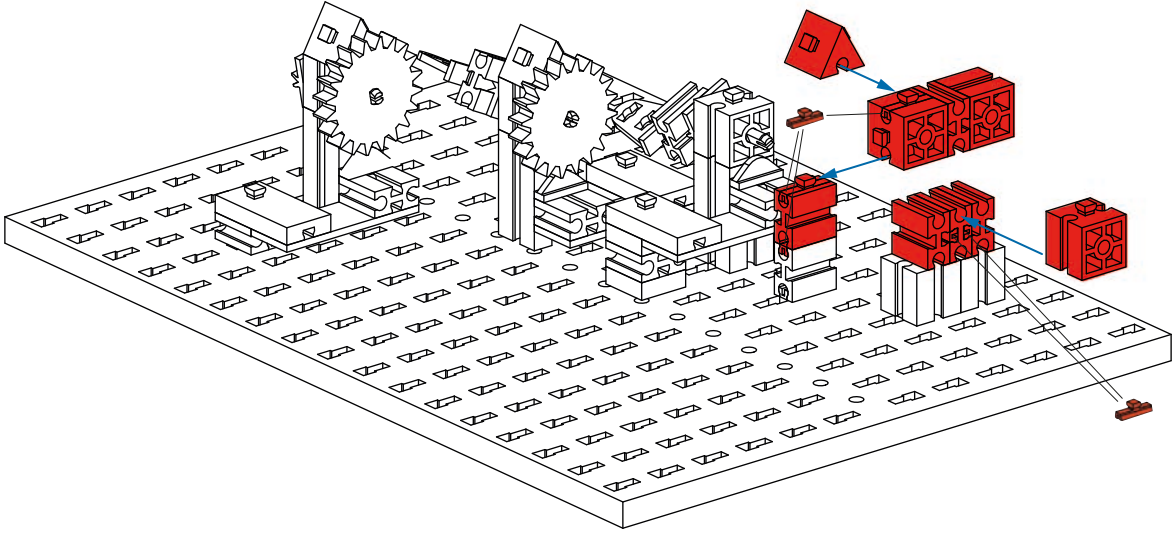
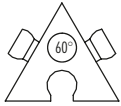

**6**

- 1x
- 2x
- 1x
- 1x
- 3x

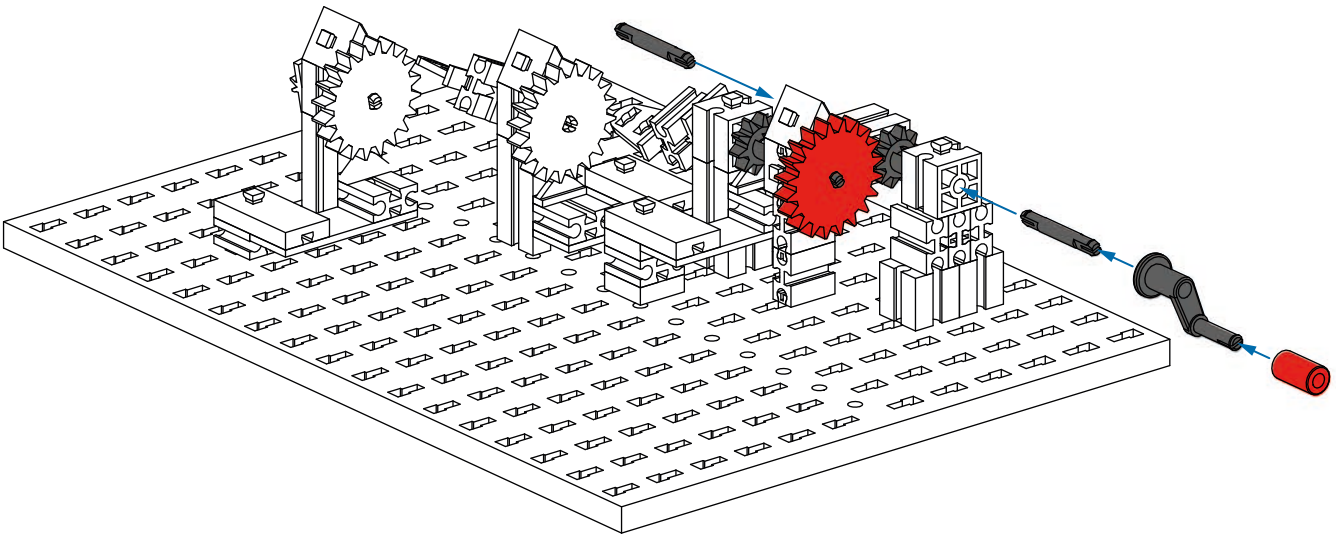

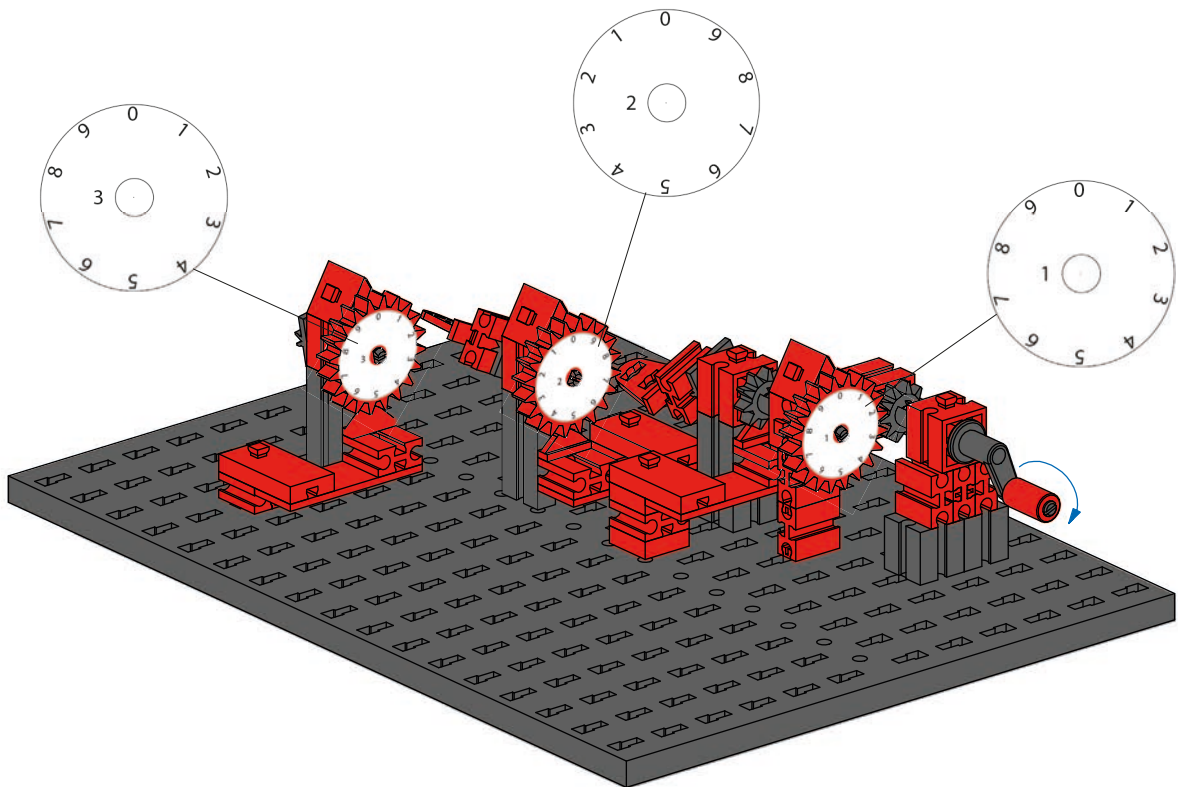
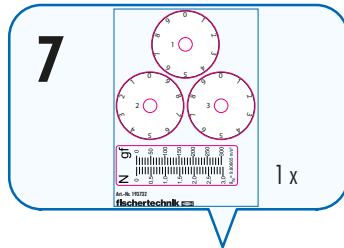





**3**

- 1 x [Red Pin]
- 4 x [Red Pin]
- 1 x [Grey Technic Beam 3x1]
- 1 x [Grey Technic Pin 40]
- 1 x [Grey Technic Pin 30]

40 mm

30 mm

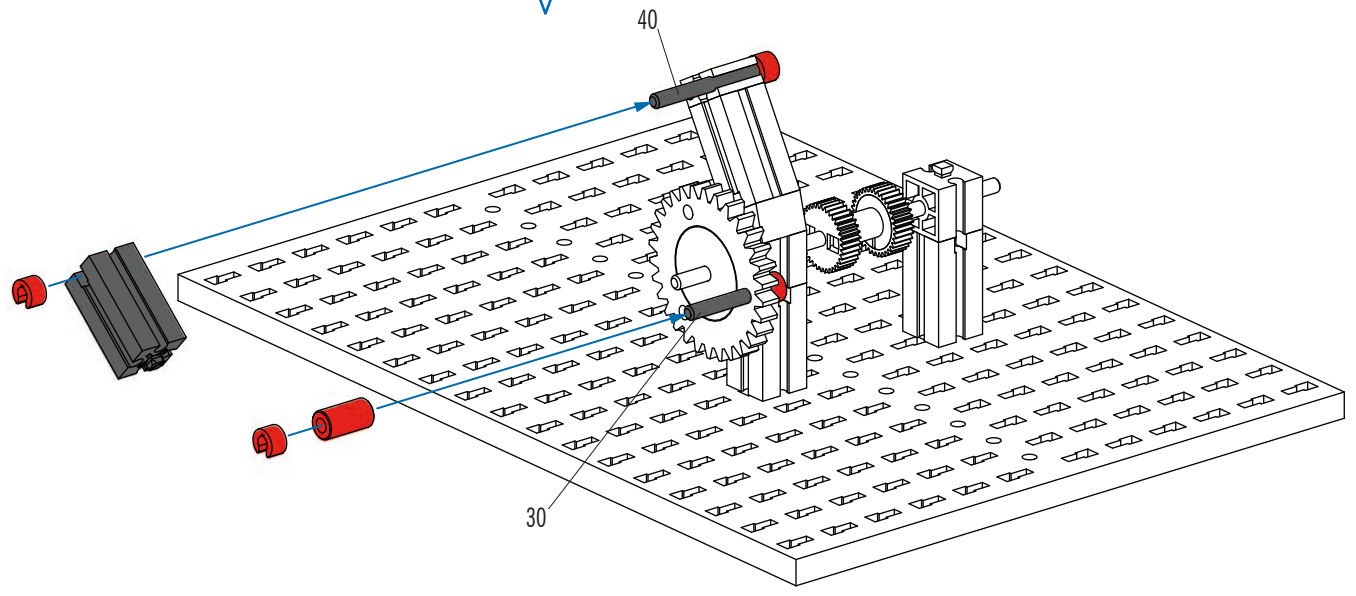

**4**

- 2 x [Red Pin]
- 4 x [Yellow Technic Beam 4x1]
- 1 x [Grey Technic Pin 40]
- 1 x [Grey Technic Pin 40]

40 mm

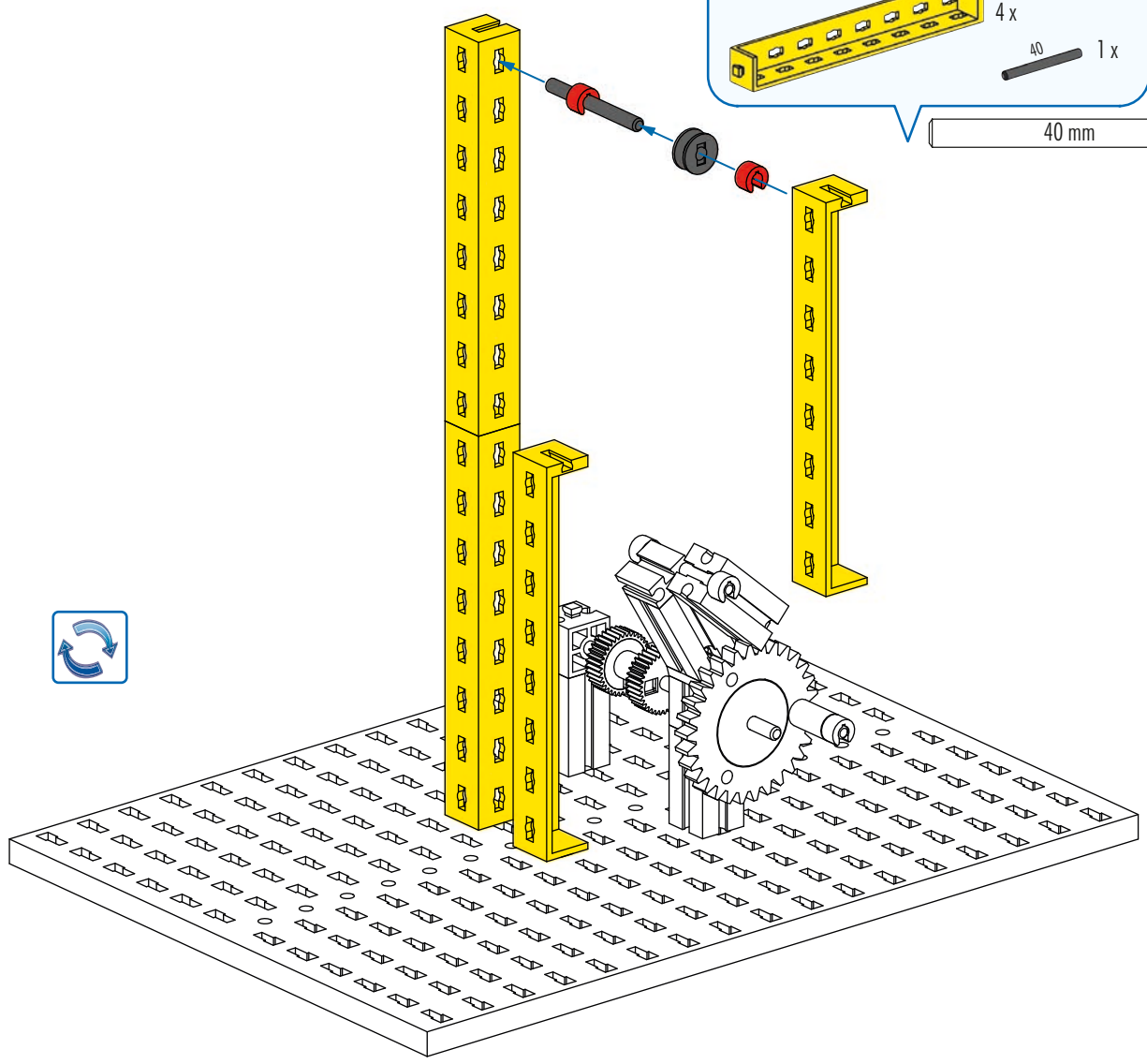

**5**

- 1x [Grey 1x3 Technic Pin]
- 1x [Red Hook]
- 3x [Red 1x3 Technic Pin]
- 2x [Grey 1x3 Technic Pin]
- 2x [Red 1x7 Technic Pin]

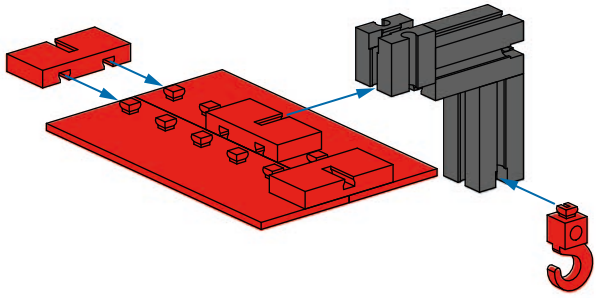

**6**

- 1x [Red Rubber Band]
- 1x [Red 1x3 Technic Pin]
- 1x [Red 1x1 Technic Pin]

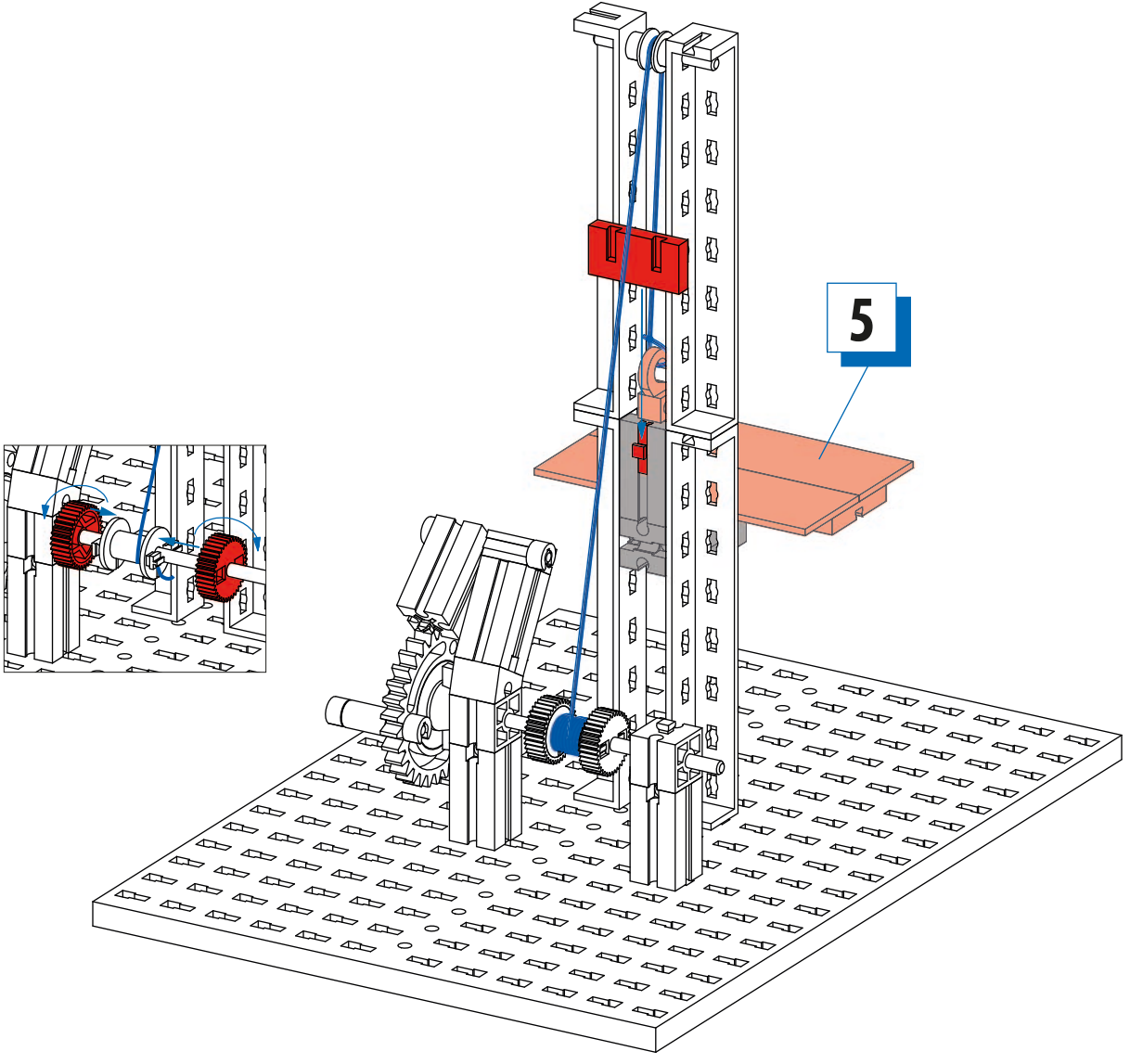

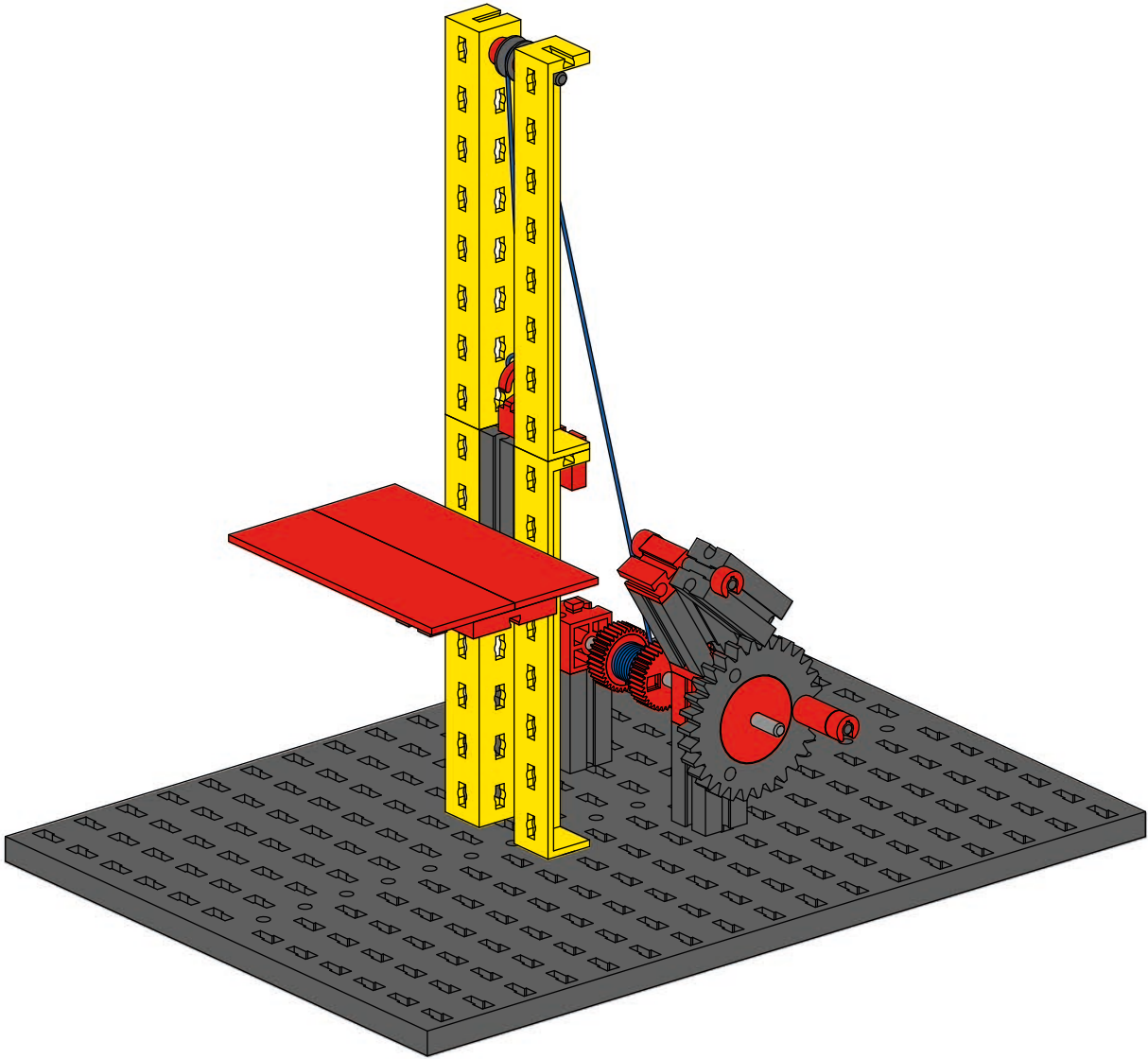



Flaschenzug  
Pulley block  
Poulie

Katrolblok  
Bloque de poleas  
Bloco de polias

Pulegge  
БЛОК ШКИВОВ  
滑轮组

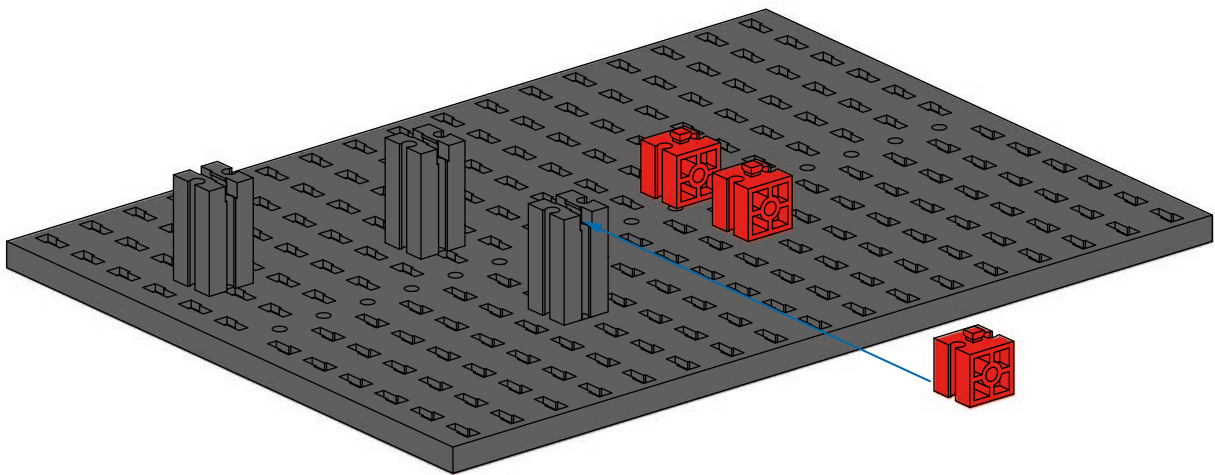
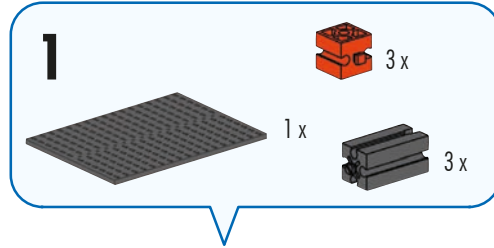

110 mm

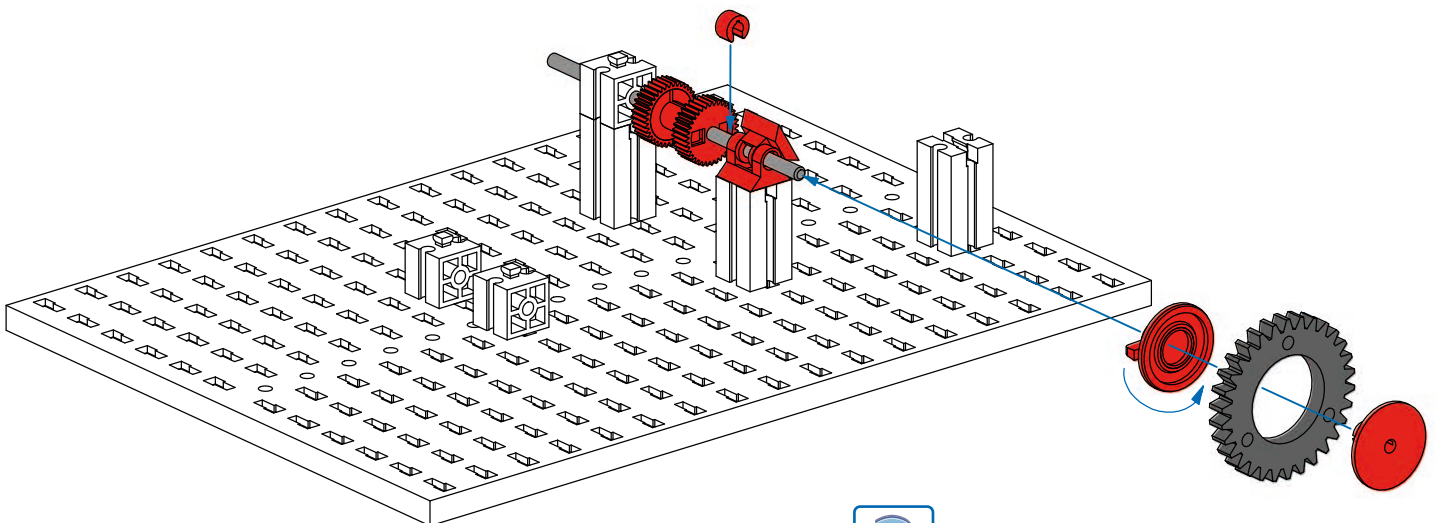
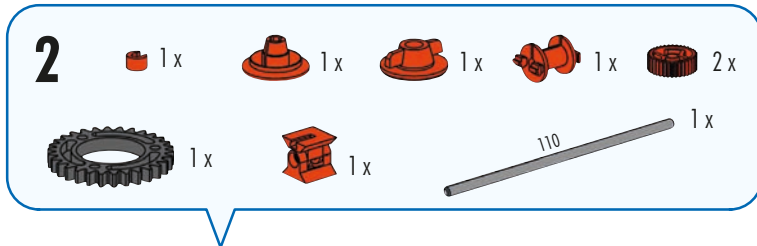

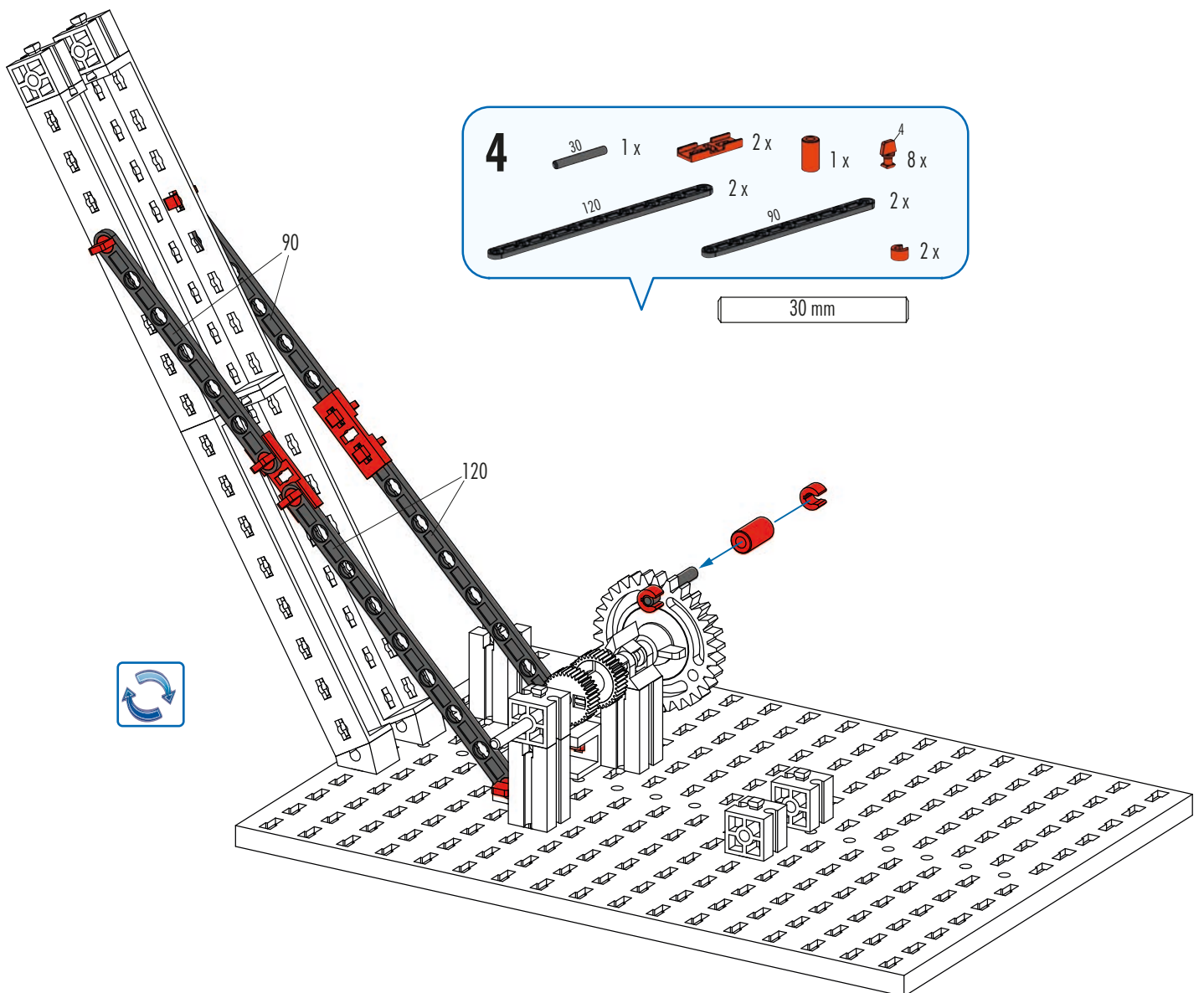
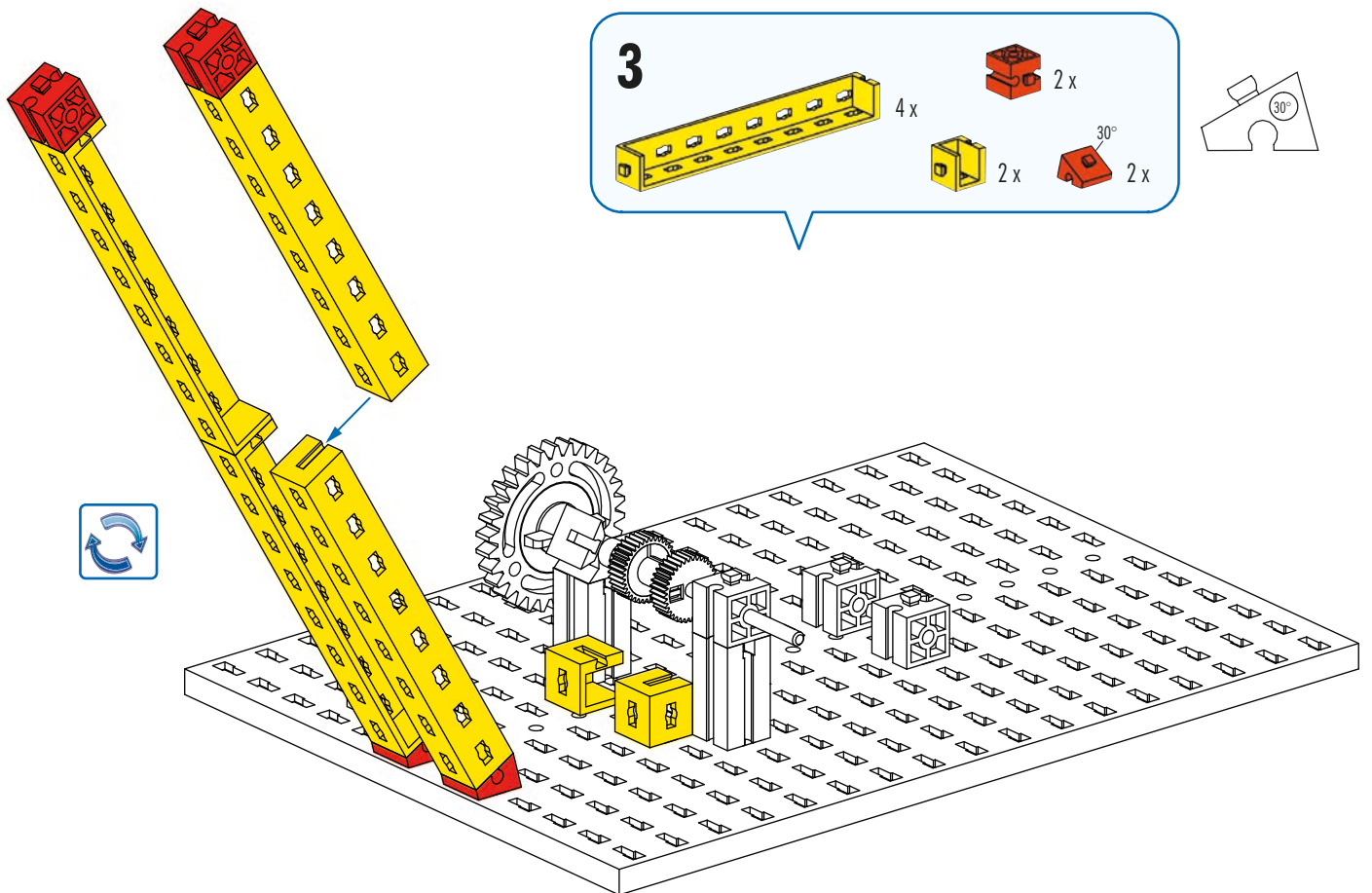

5

- 1x (red 1x2 Technic brick)
- 1x (red 1x2 Technic brick with hole)
- 1x (red 1x2 Technic brick with hole)
- 2x (red Technic pin)
- 1x (grey Technic axle)
- 1x (red 1x2 Technic brick with hole)
- 1x (red 1x2 Technic brick with hole)
- 1x (yellow Technic axle, length 30)

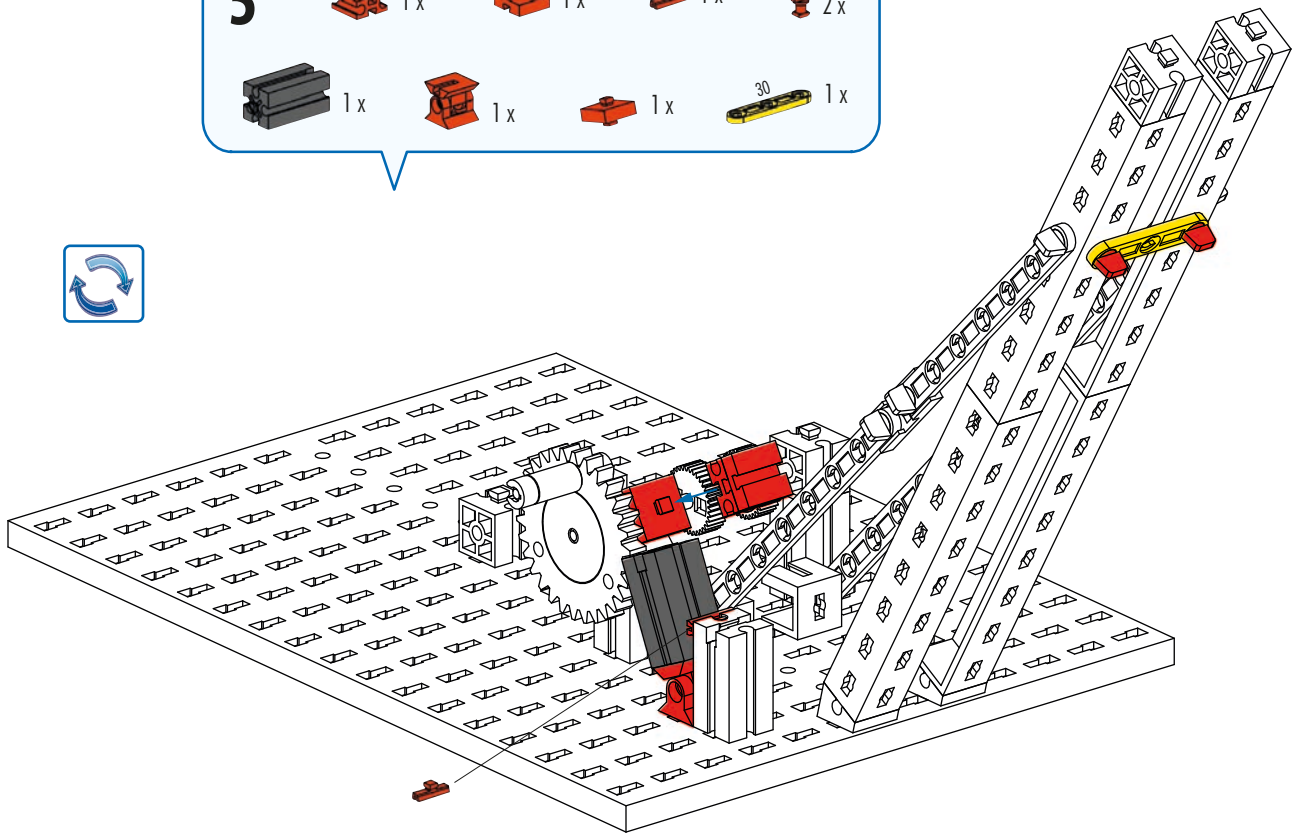

6

- 1x (black Technic pulley)
- 2x (yellow Technic axle, length 45)
- 1x (red 1x2 Technic brick with hole)
- 1x (grey Technic axle)
- 1x (grey Technic axle, length 60)
- 2x (red Technic pin)

60 mm

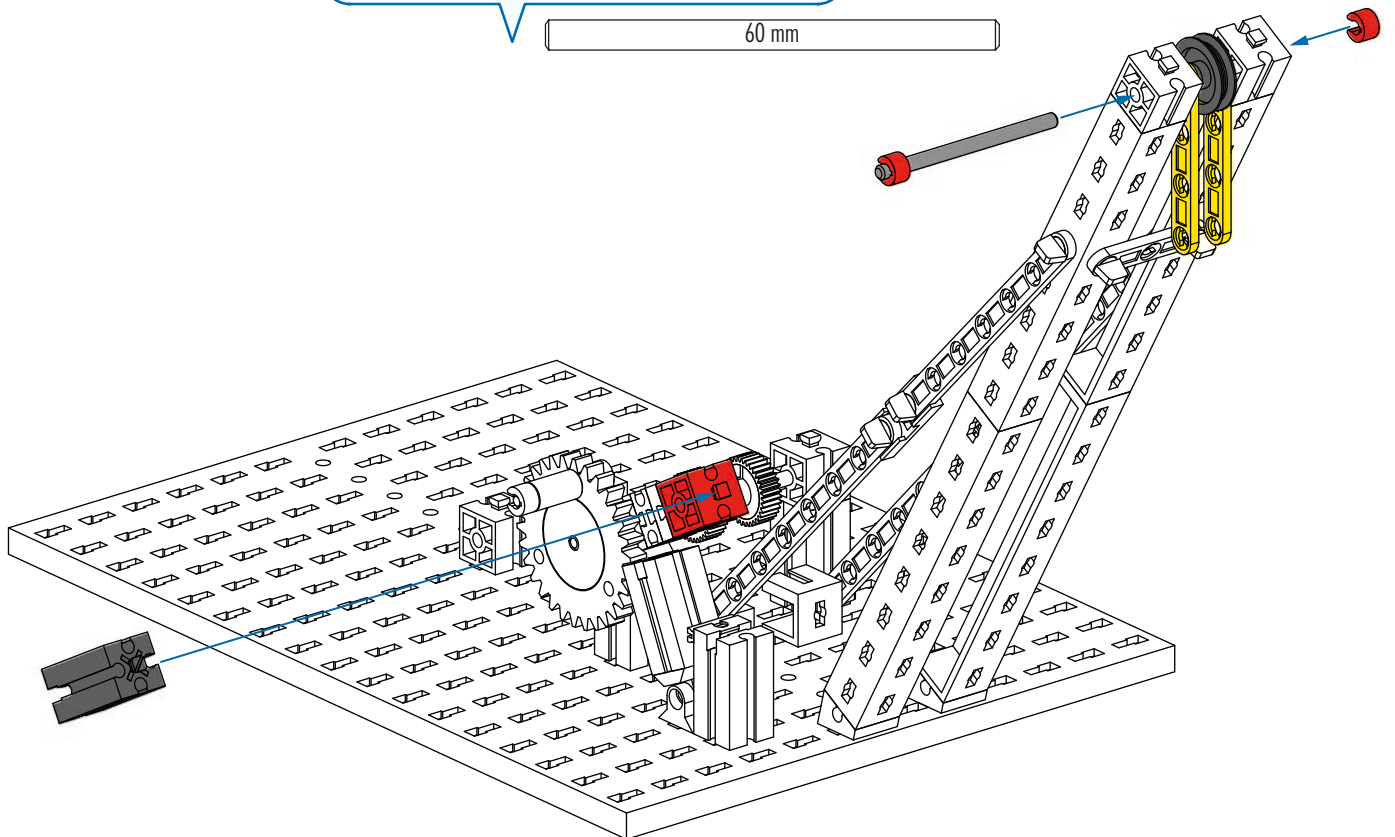

**7**

- 1x [Grey Technic Pin]
- 1x [Red Technic Beam 1x3]
- 1x [Red Technic Pin]
- 1x [Red Technic Pin]
- 1x [Grey Technic Pin]
- 1x [Red Technic Beam 1x5]
- 1x [Red Technic Pin]
- 1x [Red Technic Pin]
- 1x [Spring Scale]

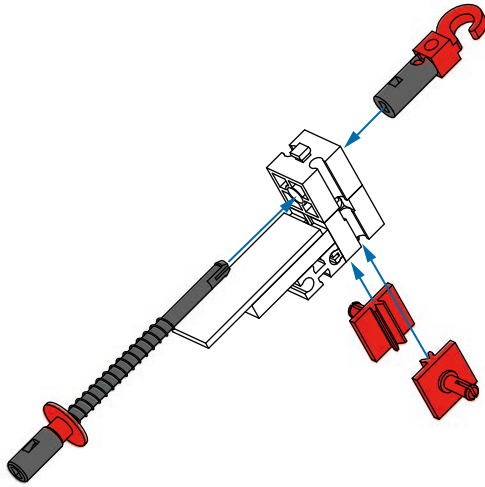
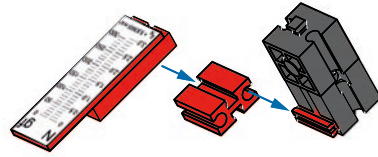

**8**

- 1x [Grey Technic Pin]
- 1x [Grey Technic Pin]
- 2x [Red Technic Pin]
- 1x [Red Technic Pin]
- 1x [Red Technic Pin]
- 1x [Red Technic Pin]
- 1x [Red Technic Pin]

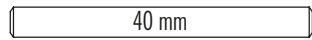
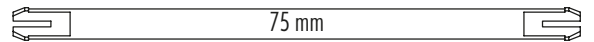

**9**

- 3x [Red Technic Pin]
- 2x [Red Technic Pin]
- 1x [Red Technic Pin]
- 2x [Red Technic Pin]

**8**

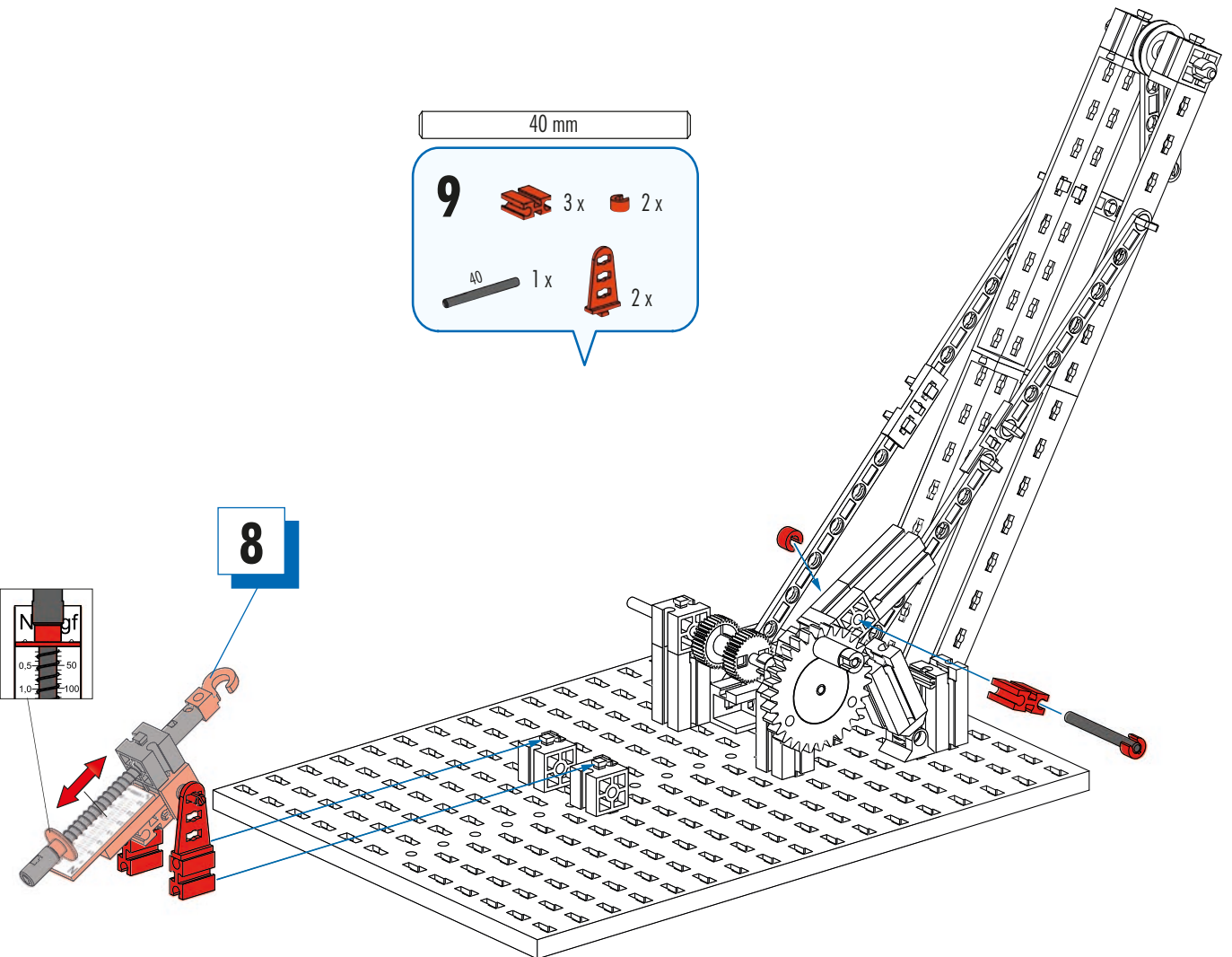
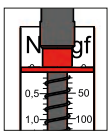

**10**

- 75 2x
- 4x
- 4x
- 2x
- 2x

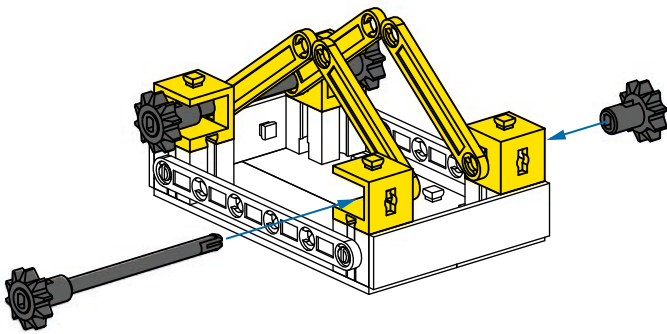
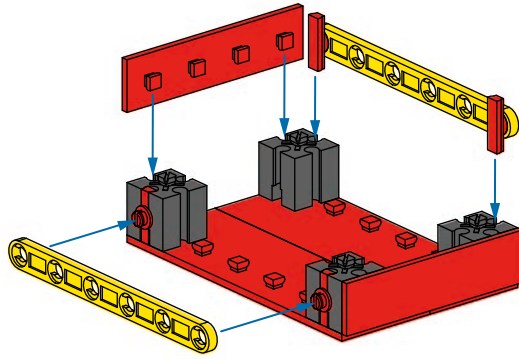

60 mm

**11**



- 4x
- 4x
- 60 2x
- 42.4 4x

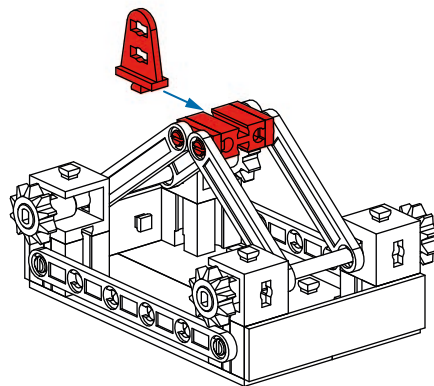

**12**

- 2x
- 1x
- 1x





**13**  1x  1x

 2x  1x  1x

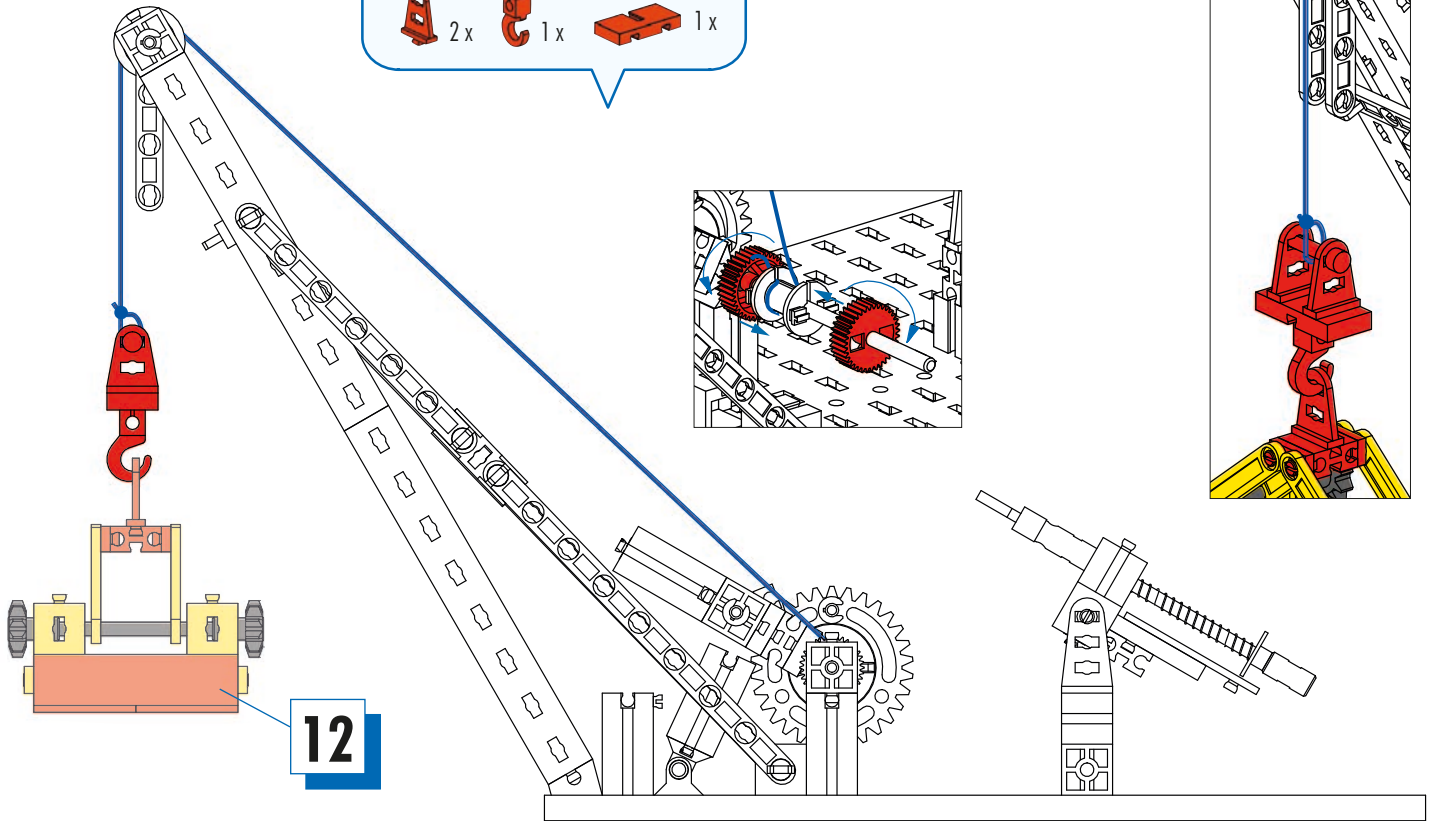

**12**

**13** umbauen  
modify  
modifier  
veranderen  
modificar  
modificar  
modificare  
переделать  
改装

**14**  1x

 1x

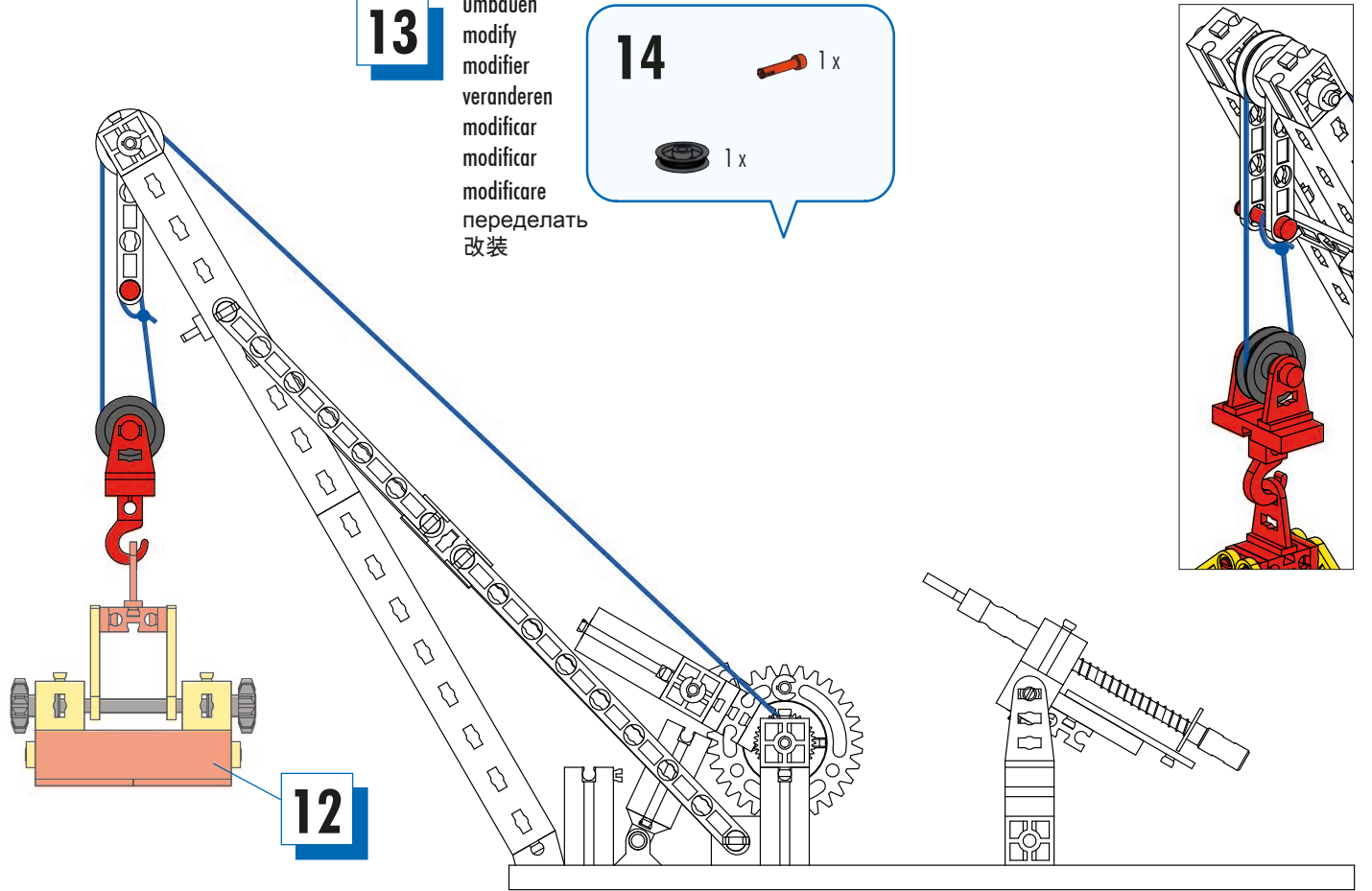

**12**

**14**

umbauen  
modify  
modifier  
veranderen  
modificar  
modificar  
modificare  
переделать  
改装

**15**

1 x

1 x

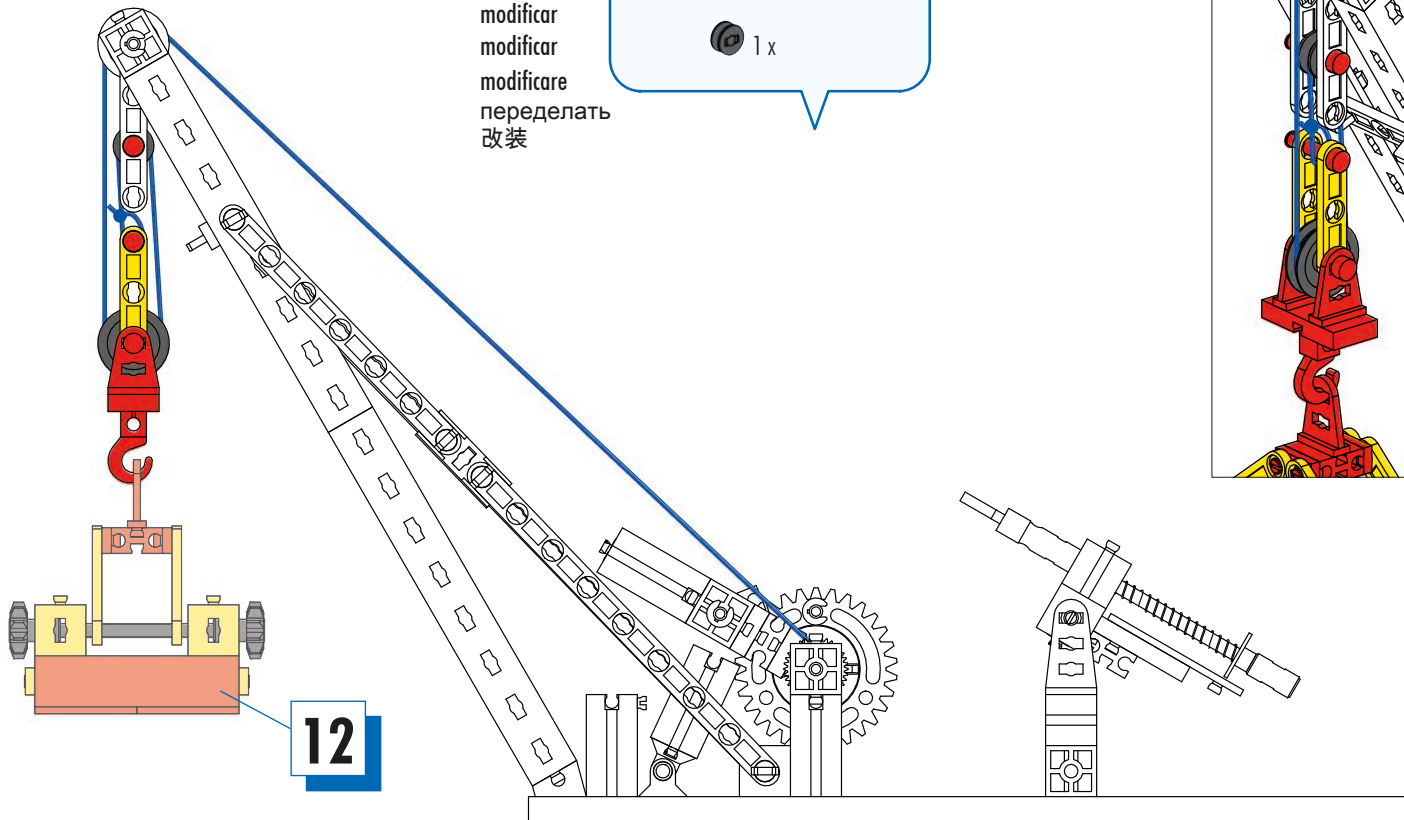

**12**

**15**

umbauen  
modify  
modifier  
veranderen  
modificar  
modificar  
modificare  
переделать  
改装

**16**

1 x

1 x

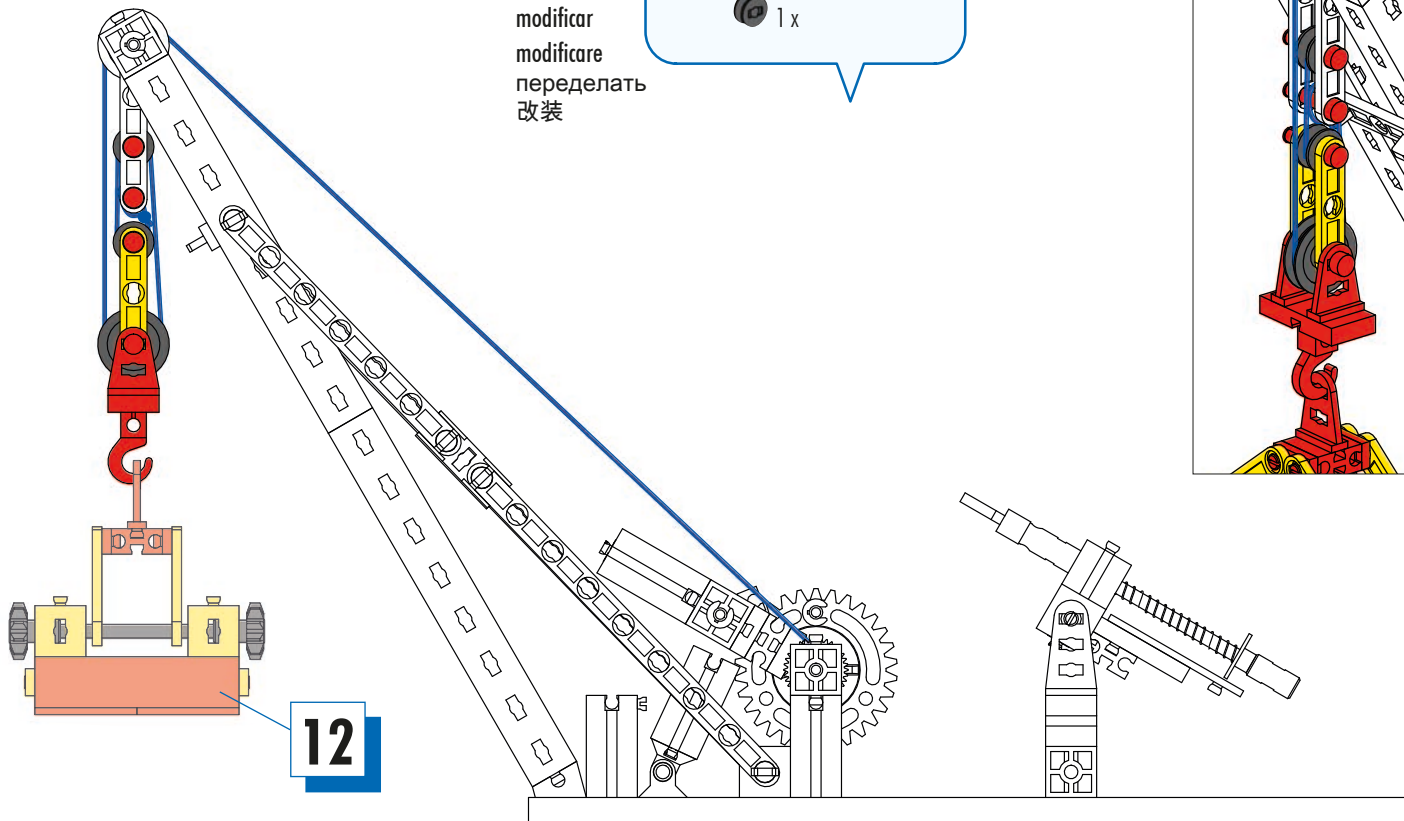

**12**

umbauen  
 modify  
 modifier  
 veranderen  
 modificar  
 modificar  
 modificare  
 переделать  
 改装

17



1 x



1 x



2 x

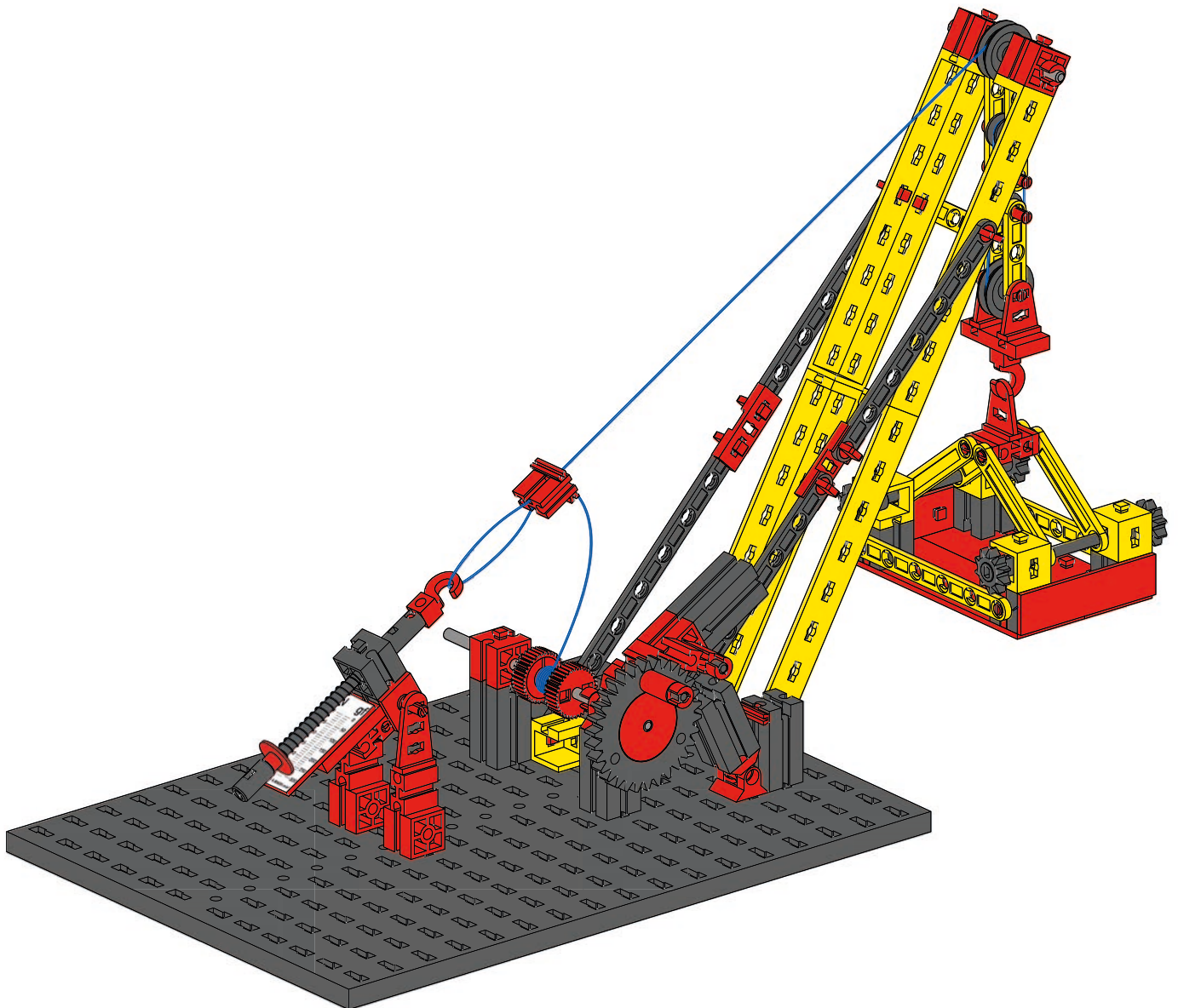
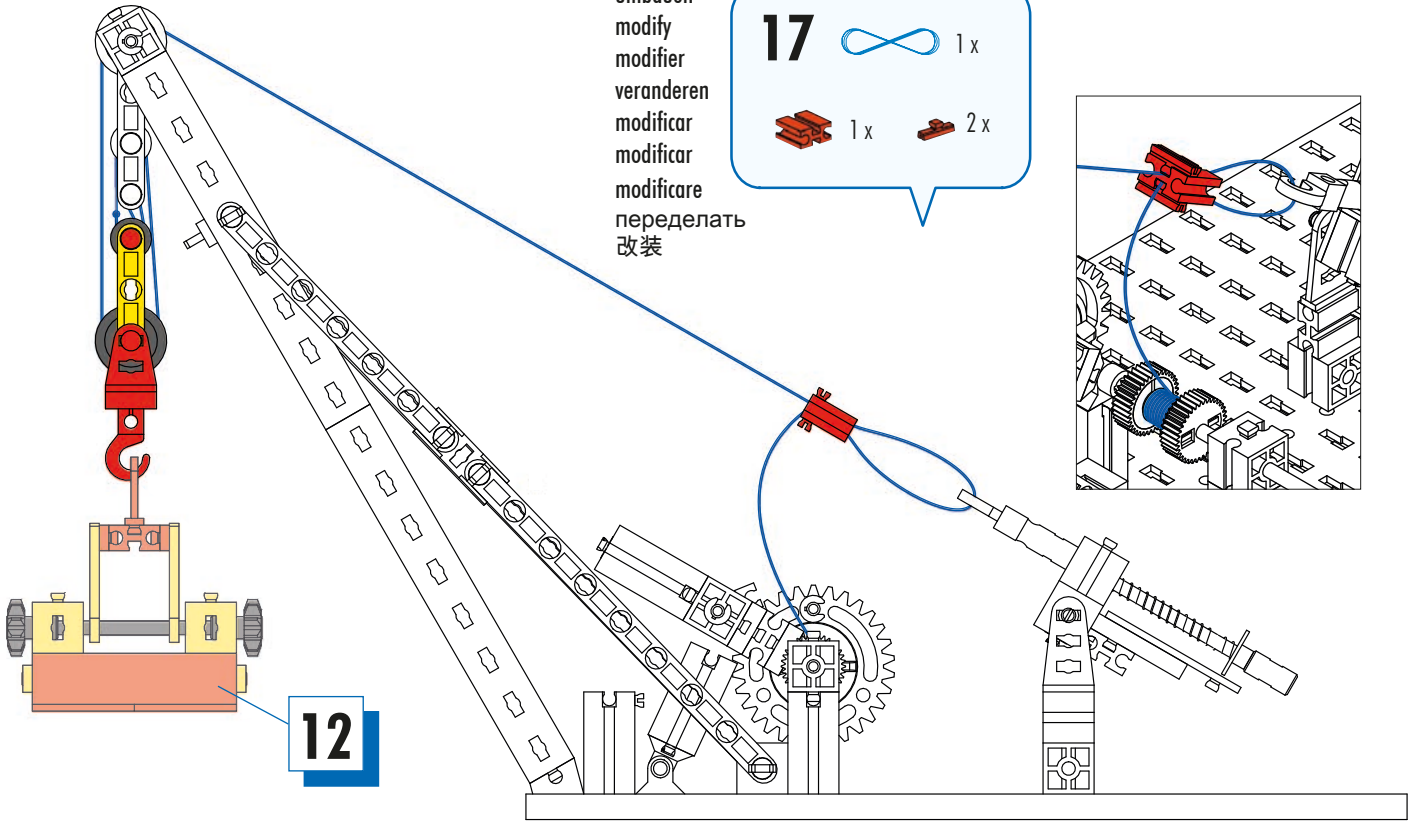
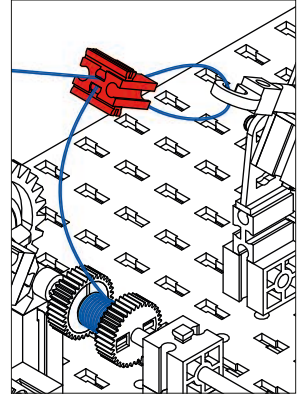

Warenautomat  
Vending machine  
Distributeur automatique  
de marchandises

Verkoopautomaat  
Máquina expendedora  
Máquina de venda automática

Distributore automatico  
Торговый автомат  
自动售货机

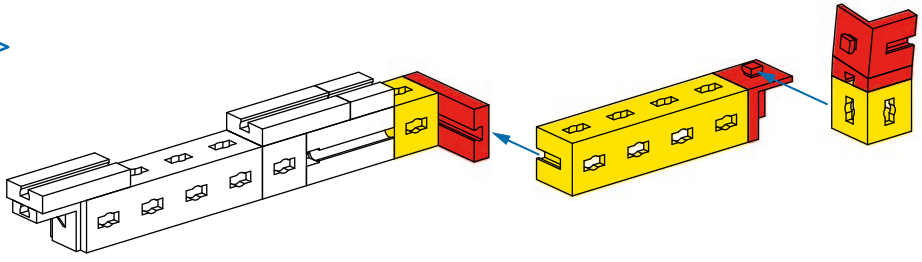
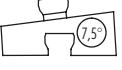
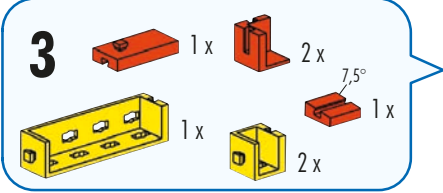
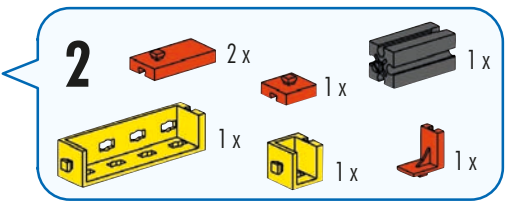
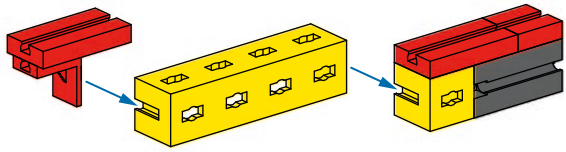
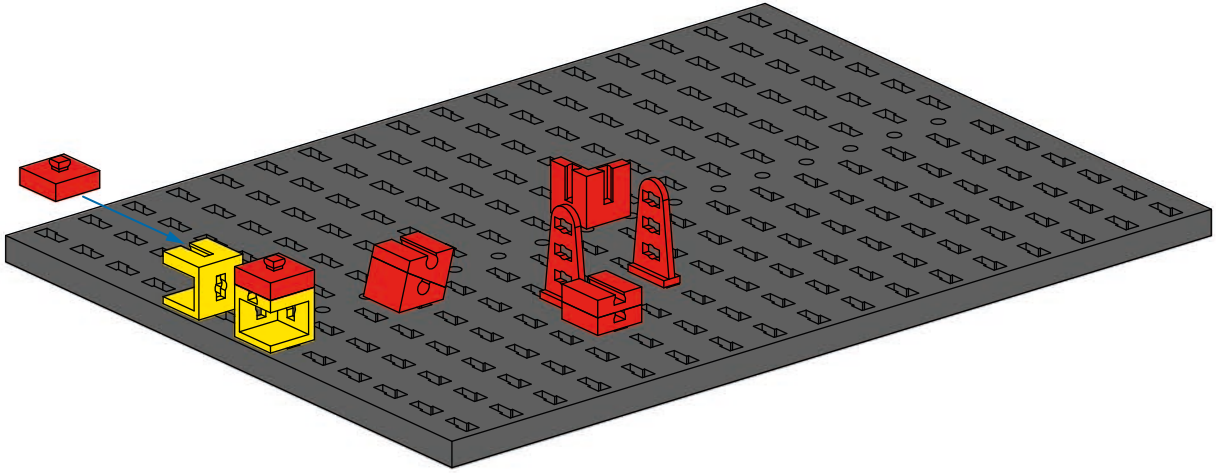
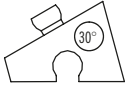
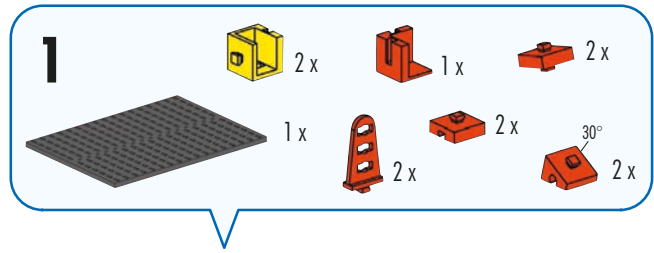
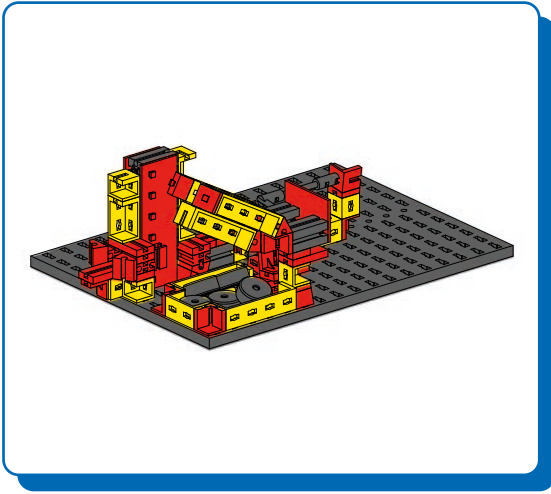

**4**

- 15 1x
- 1x
- 30° 3x

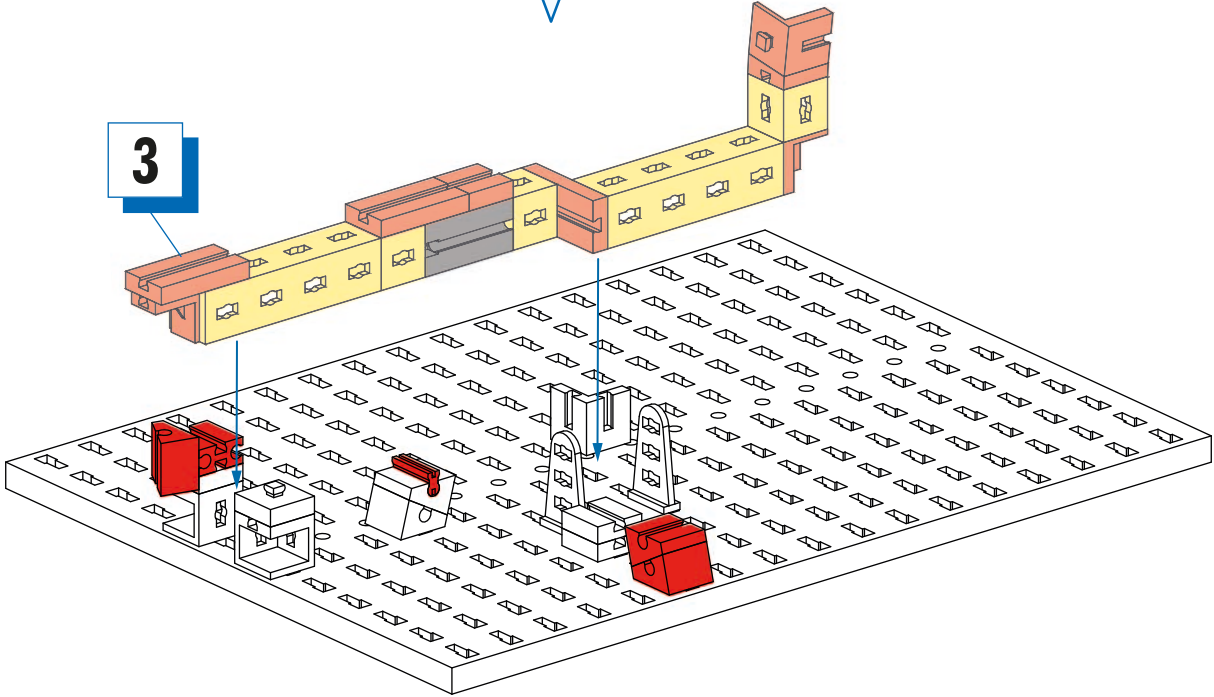

**5**

- 2x
- 2x
- 2x
- 4x
- 1x
- 1x

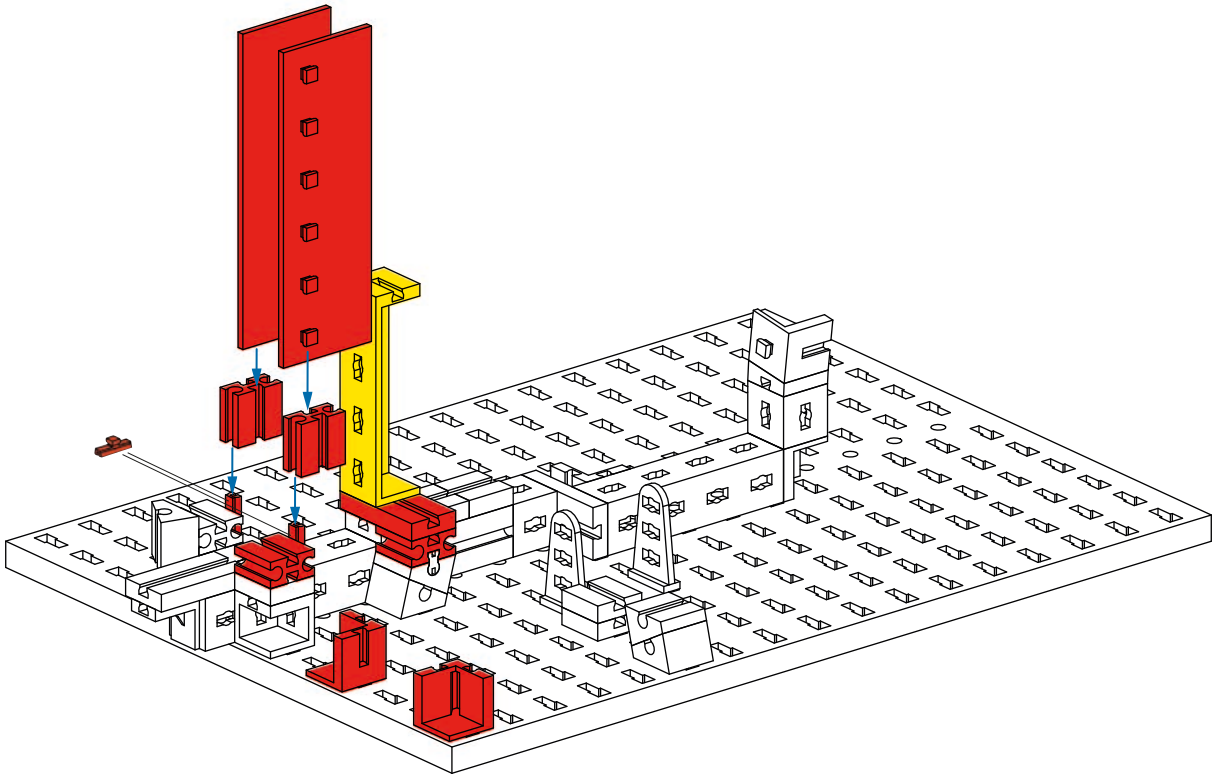

6

- 1 x (red 1x3 Technic brick)
- 1 x (red 1x2 Technic brick)
- 1 x (red 30° Technic wedge)
- 2 x (yellow 1x5 Technic beam)
- 1 x (yellow 1x2 Technic connector)
- 2 x (yellow 1x3 Technic connector)
- 5 x (black 1x2 Technic axle)

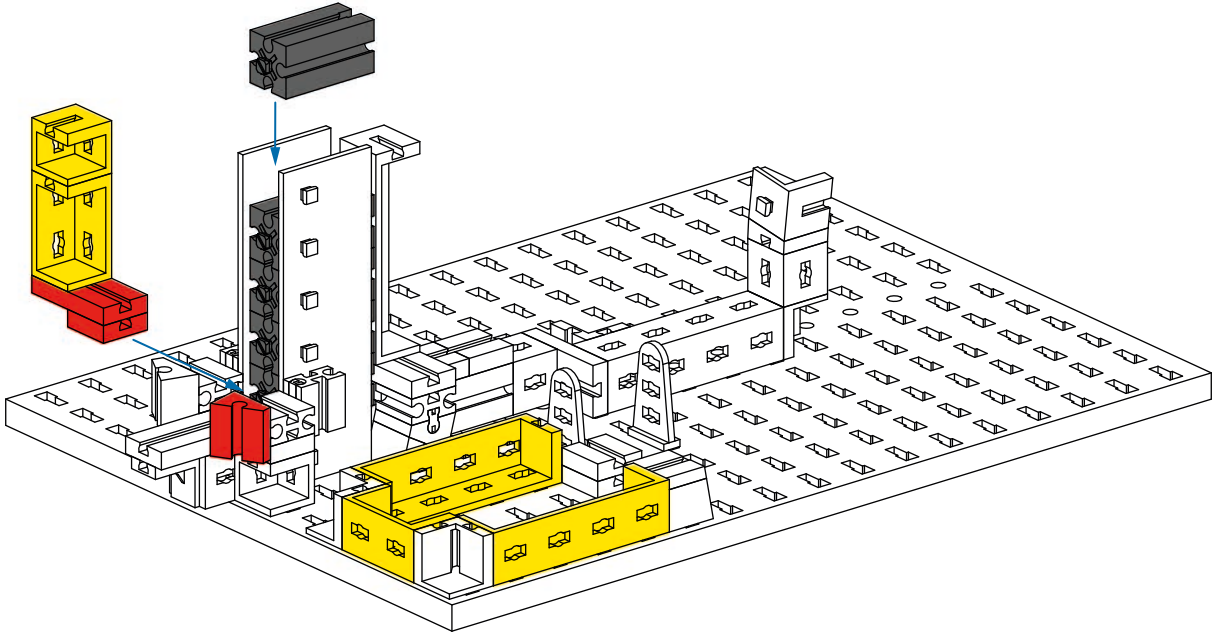
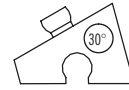

7

- 1 x (red 1x3 Technic brick)
- 1 x (red 1x2 Technic brick)
- 2 x (red 1x2 Technic connector)
- 1 x (black 1x2 Technic axle)
- 1 x (red 1x2 Technic brick)
- 1 x (red 1x1 Technic pin)
- 1 x (yellow 1x2 Technic connector)

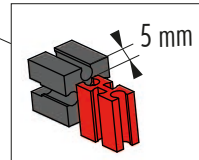
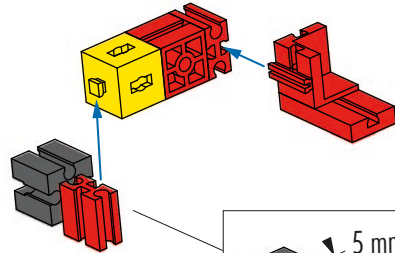

8

- 6 x (grey Technic wheels)
- 1 x (red 1x2 Technic brick)
- 1 x (black 40 mm Technic axle)
- 2 x (red 1x2 Technic connector)

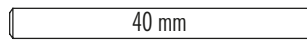

7

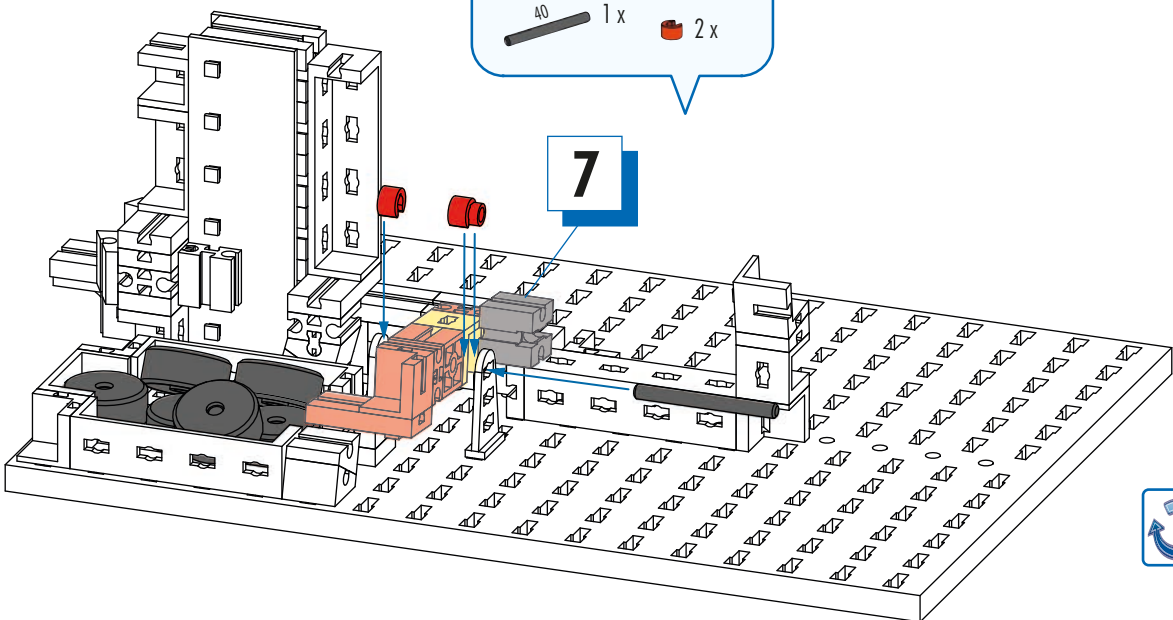

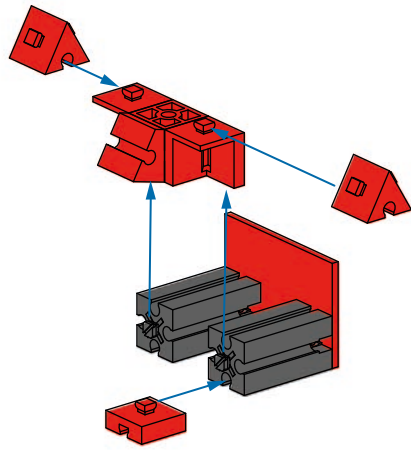

**9**

- 30° 1x
- 60° 2x
- 2x
- 1x
- 2x
- 1x
- 2x
- 1x
- 1x

**10**

- 30° 2x
- 1x
- 3x
- 1x

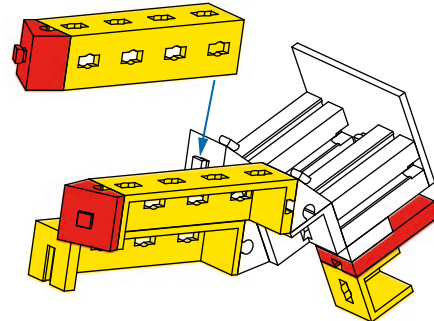

**11**

- 2x
- 1x
- 60 1x
- 45 1x

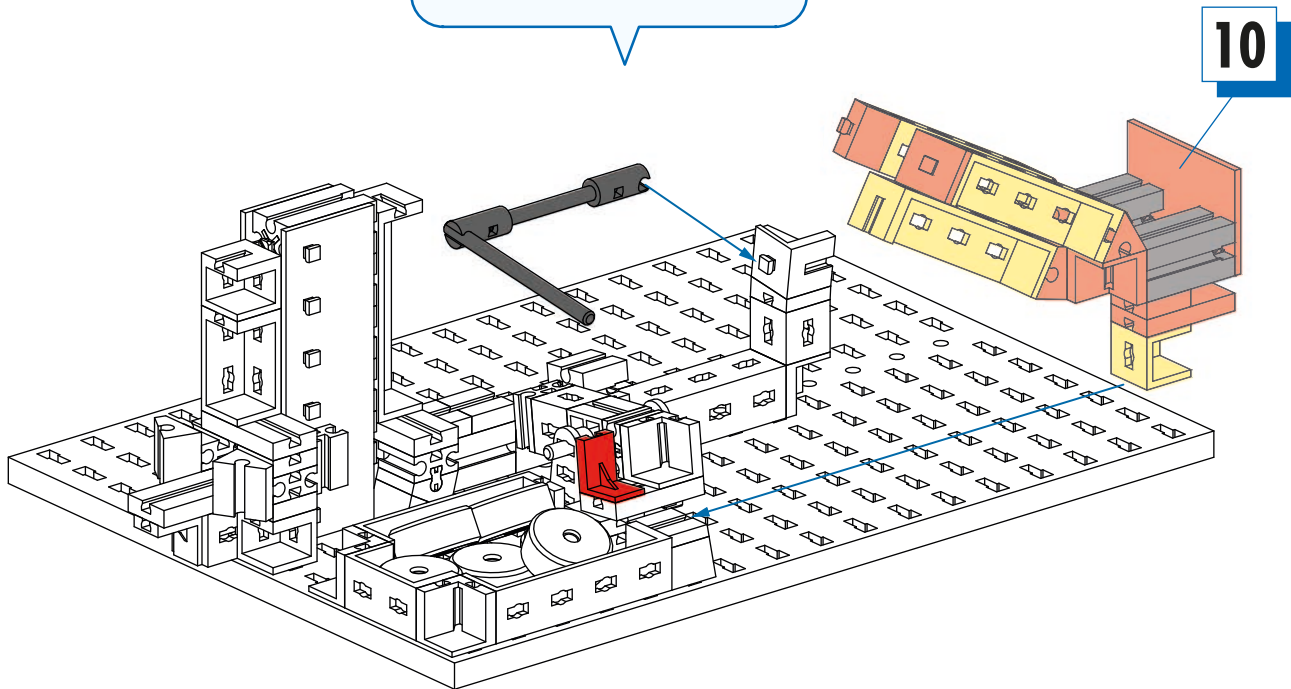
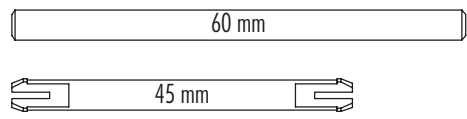

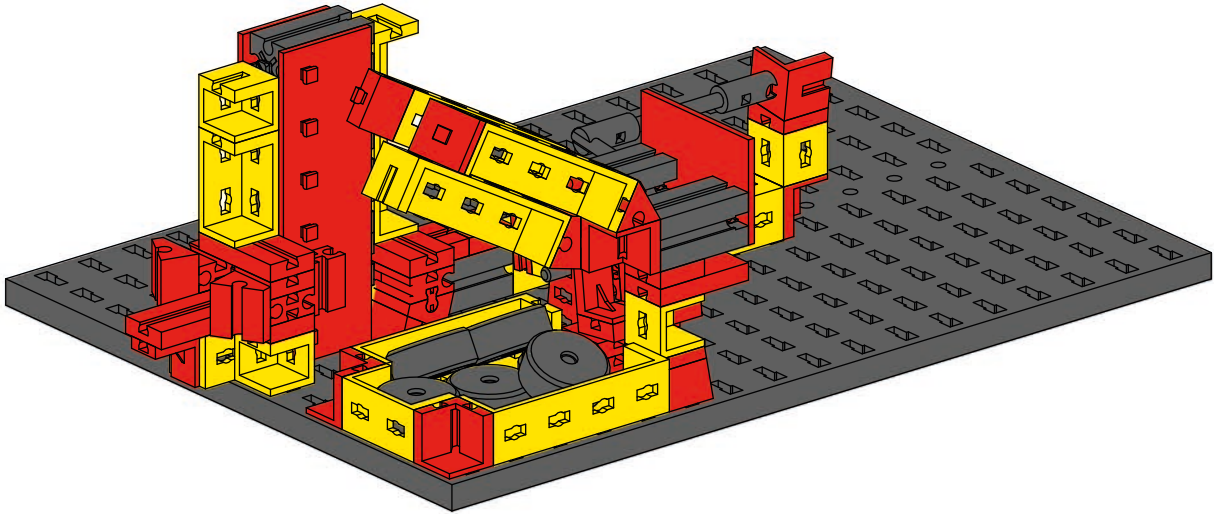



Ausgleichsgetriebe  
 Differential gear  
 Réducteur de compensation  
 Differentieel

Engranaje diferencial  
 Engrenagem diferencial  
 Ingranaggio differenziale

ифференциальная  
 передача  
 差速器齿轮

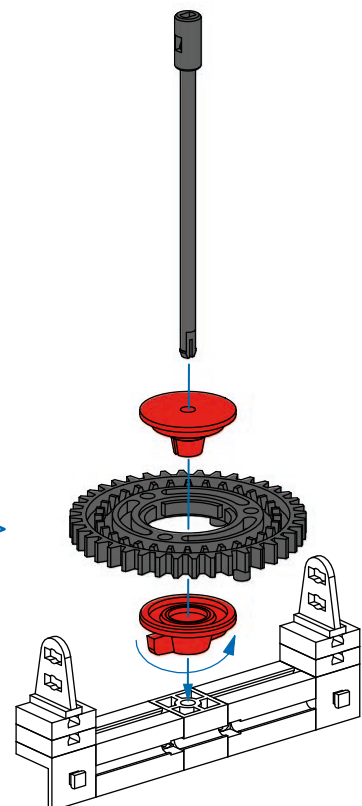
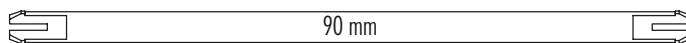
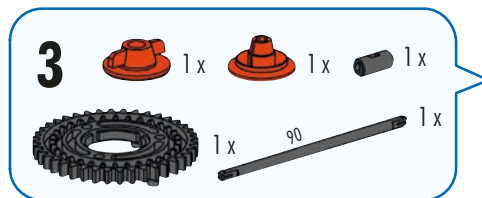
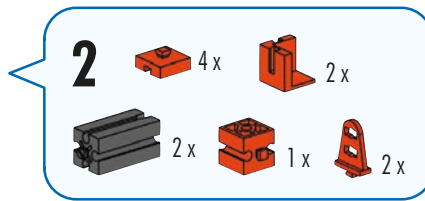
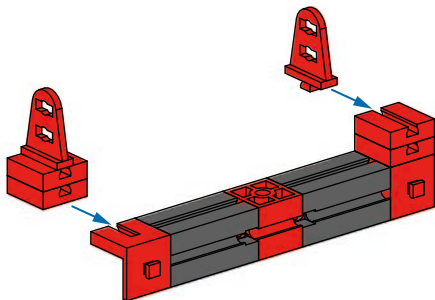
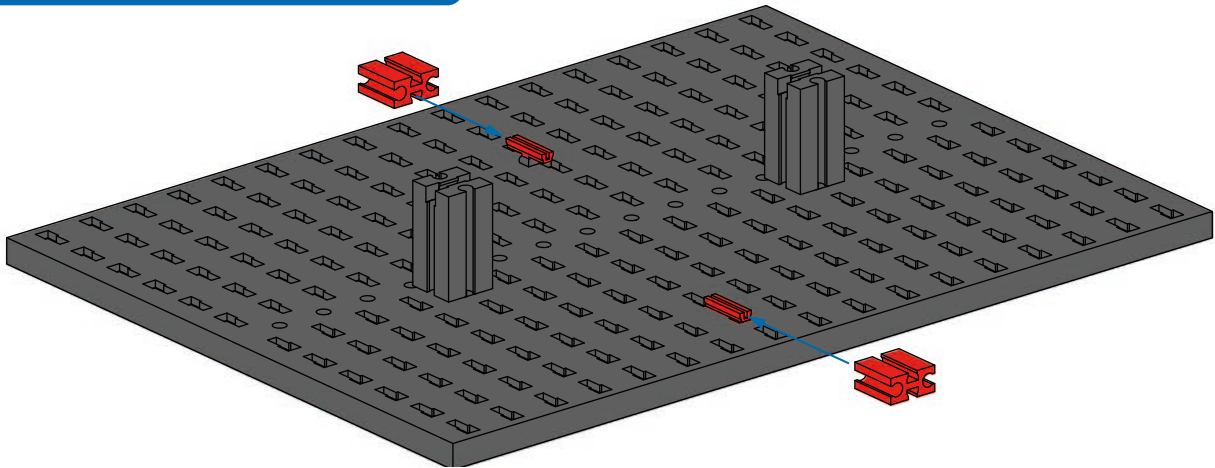
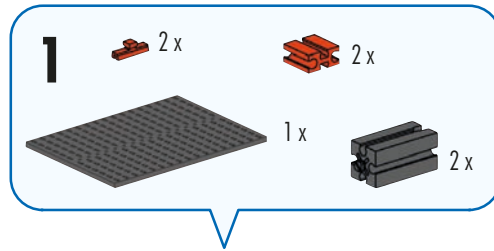
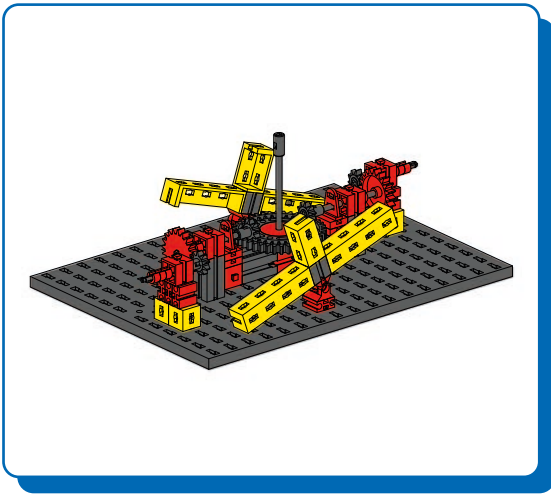

**4**

- 2 x Black Pin
- 2 x Red 1x2 Technic Brick
- 2 x Red 1x2 Technic Brick with Hole
- 2 x Red Pin
- 2 x Red 24 Tooth Gear
- 2 x Grey 60 mm Technic Pin

60 mm

**3**

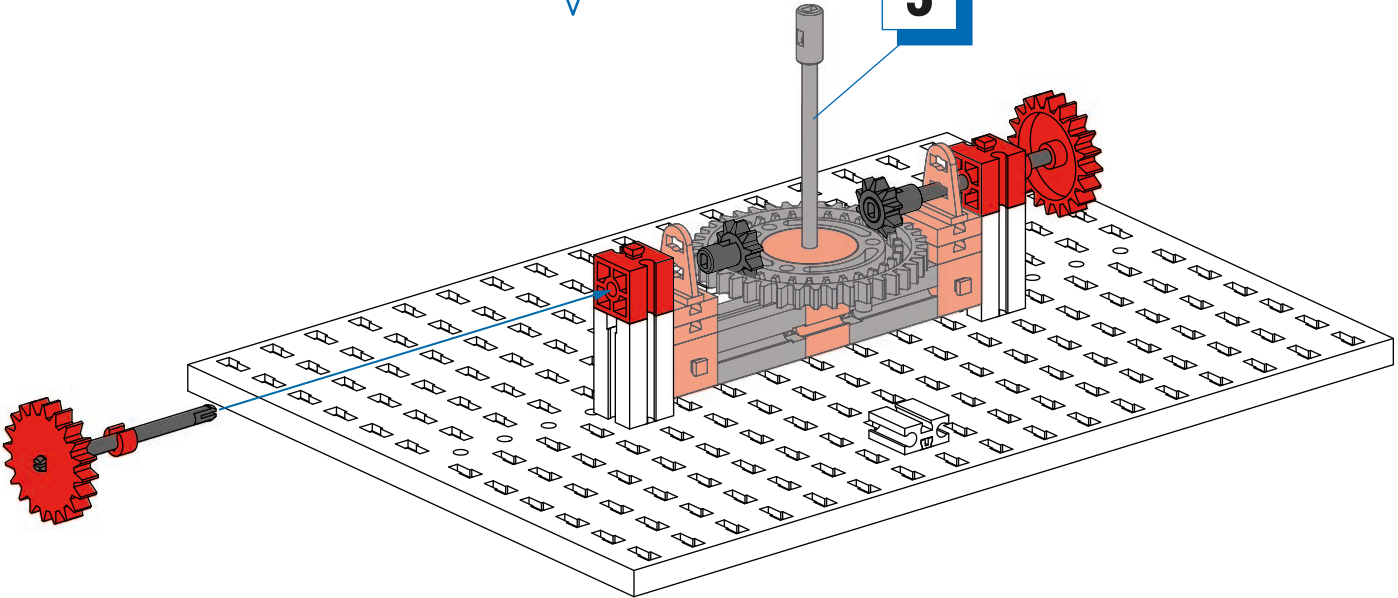

**5**

- 2 x Yellow 1x2 Technic Beam
- 1 x Black 1x2 Technic Beam
- 3 x Red 1x2 Technic Brick
- 2 x Red Pin
- 2 x Yellow 1x4 Technic Beam
- 1 x Yellow 1x2 Technic Beam with Hole
- 1 x Red 1x2 Technic Brick with Hole

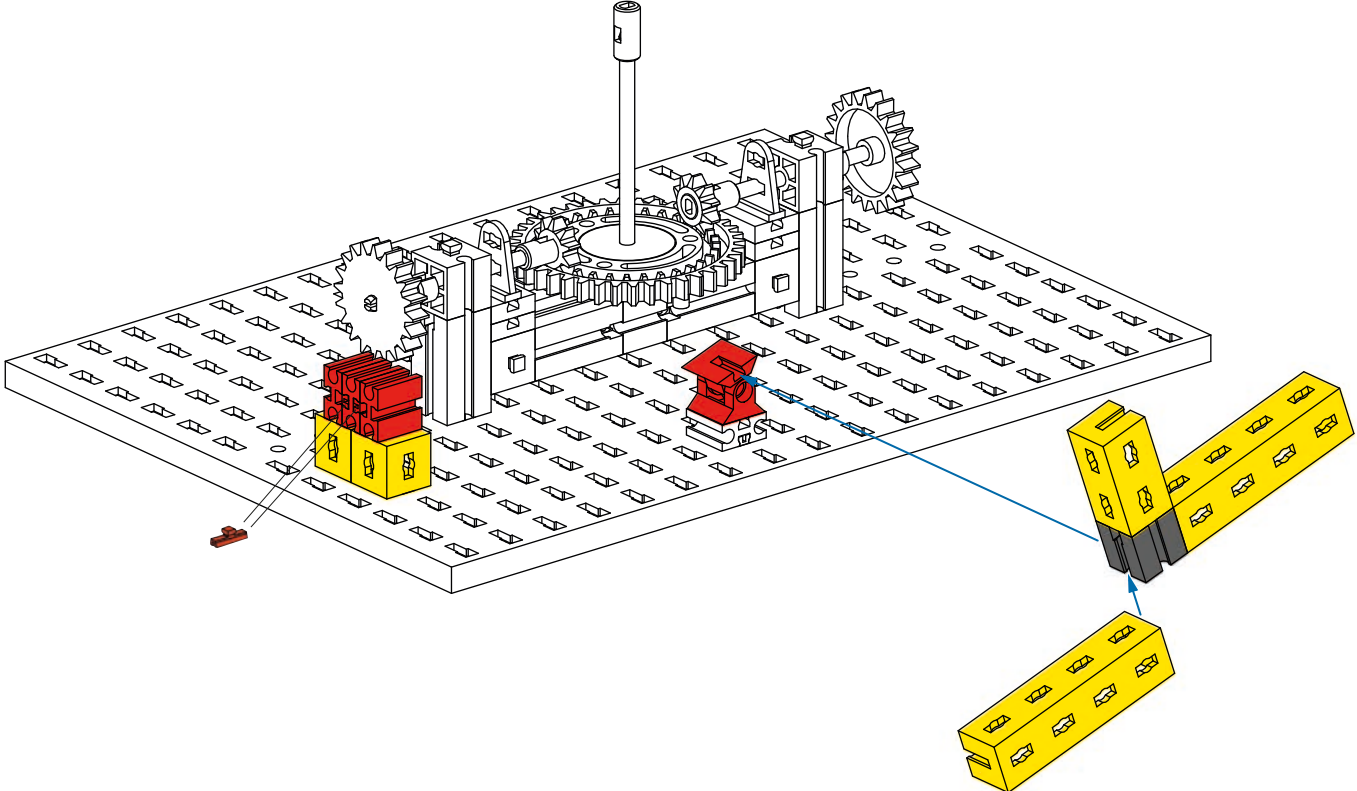

**6**

- 1 x black axle pin
- 1 x red 1x2 Technic brick
- 1 x grey 45 mm axle
- 3 x red 1x1 Technic pins

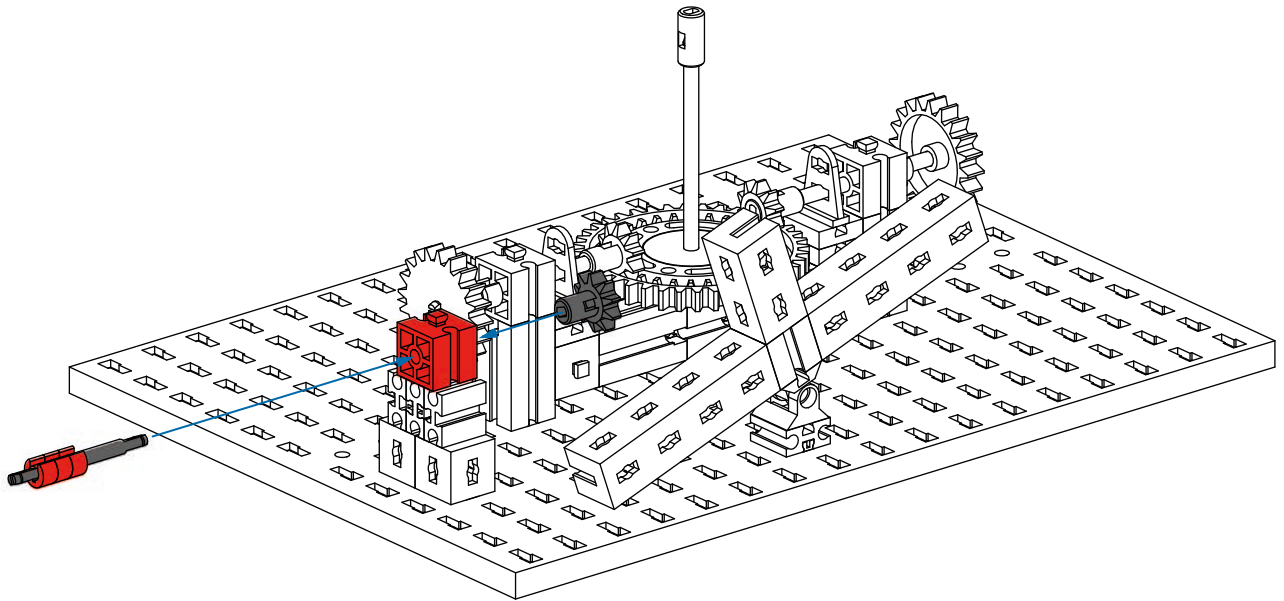

45 mm



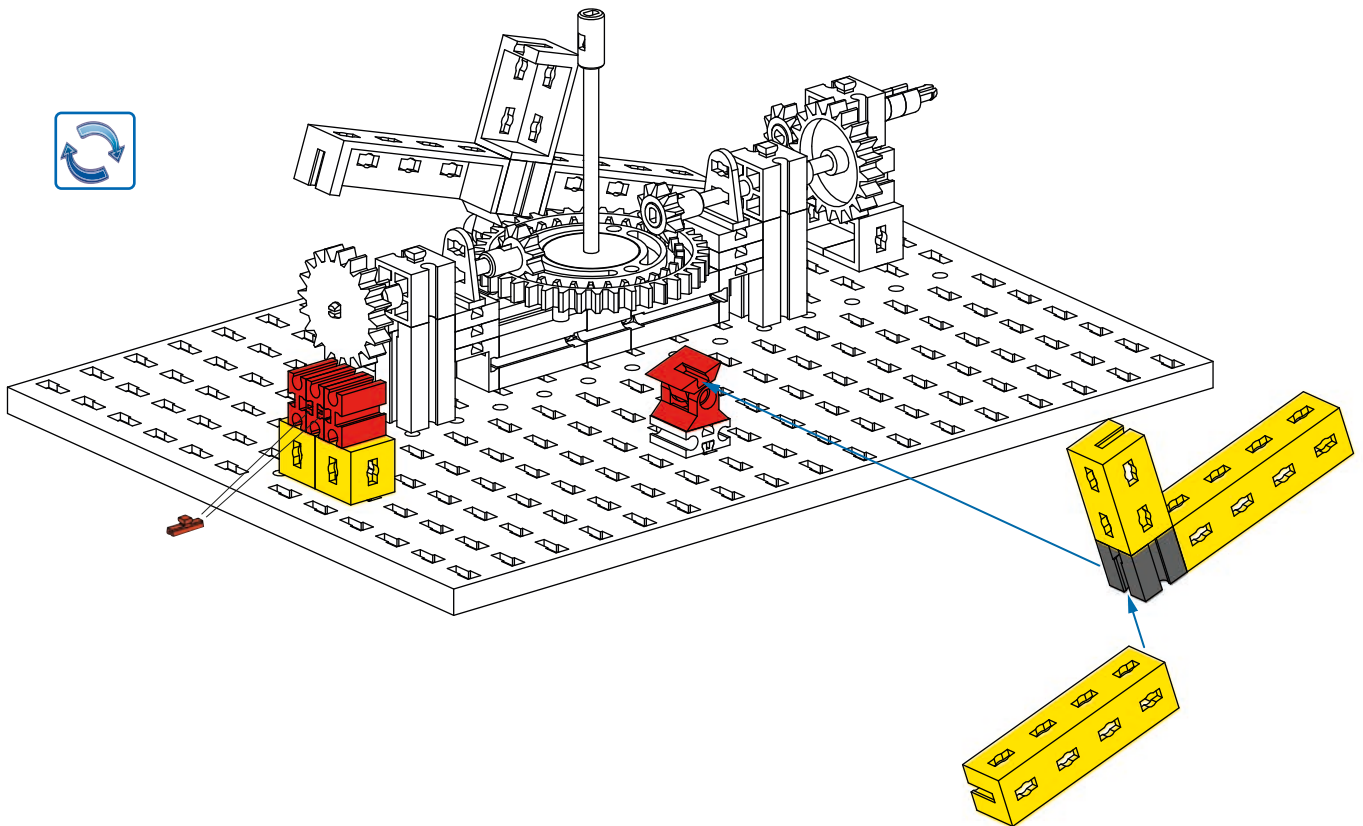

**7**

- 2 x yellow 1x3 Technic Technic beam
- 1 x grey 1x2 Technic Technic beam
- 3 x red 1x2 Technic Technic beam
- 2 x red 1x1 Technic pins
- 2 x yellow 1x3 Technic Technic beam
- 1 x yellow 1x2 Technic Technic beam
- 1 x red 1x2 Technic Technic beam

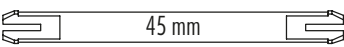

8  1x  1x  45 mm

 45 1x  3x

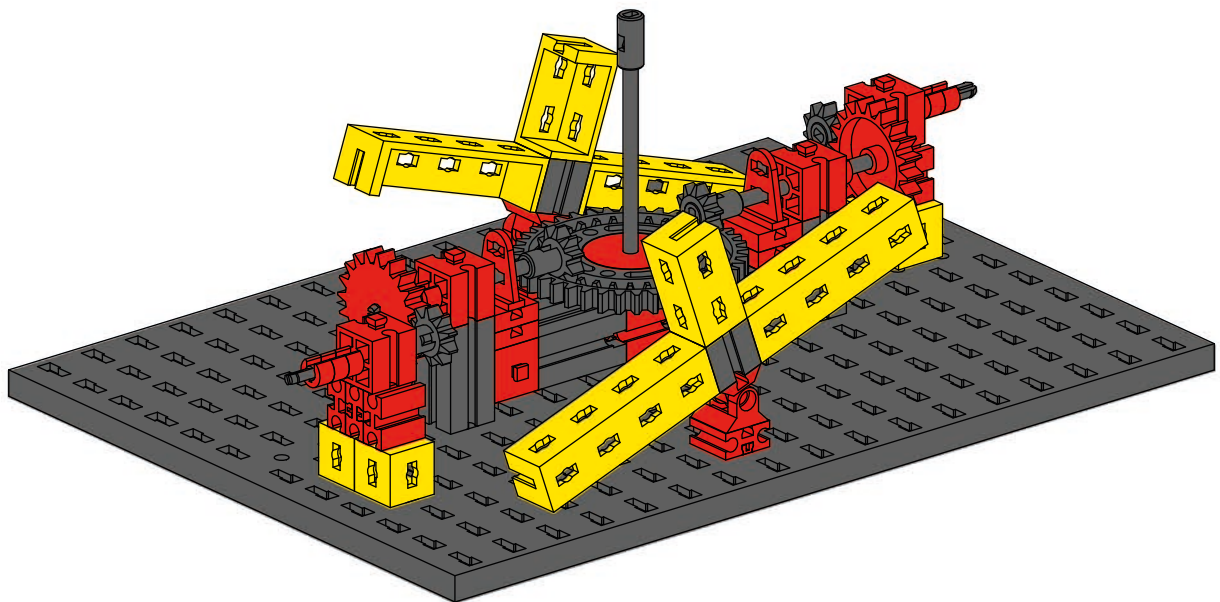
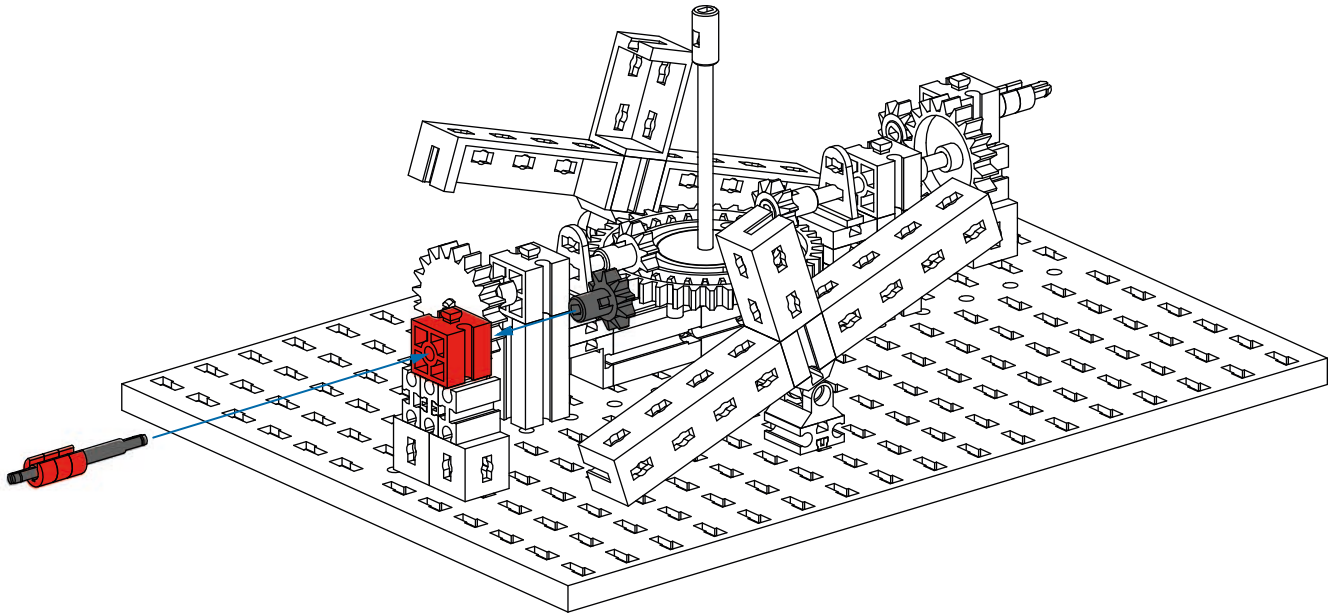

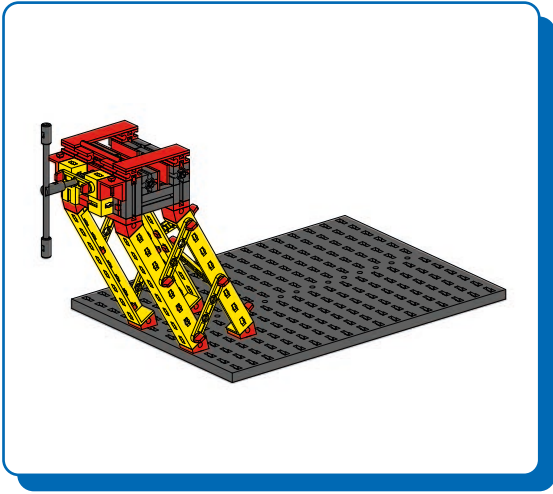

Schraubstock  
Vise  
Etau

Bankschroef  
Tornillo de banco  
Torno de bancada

Morsa a vite  
Тиски  
虎钳

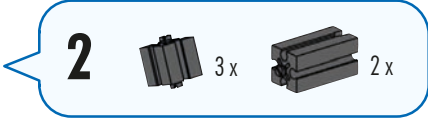
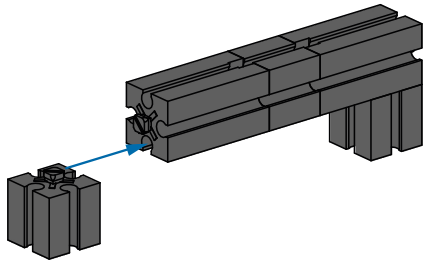
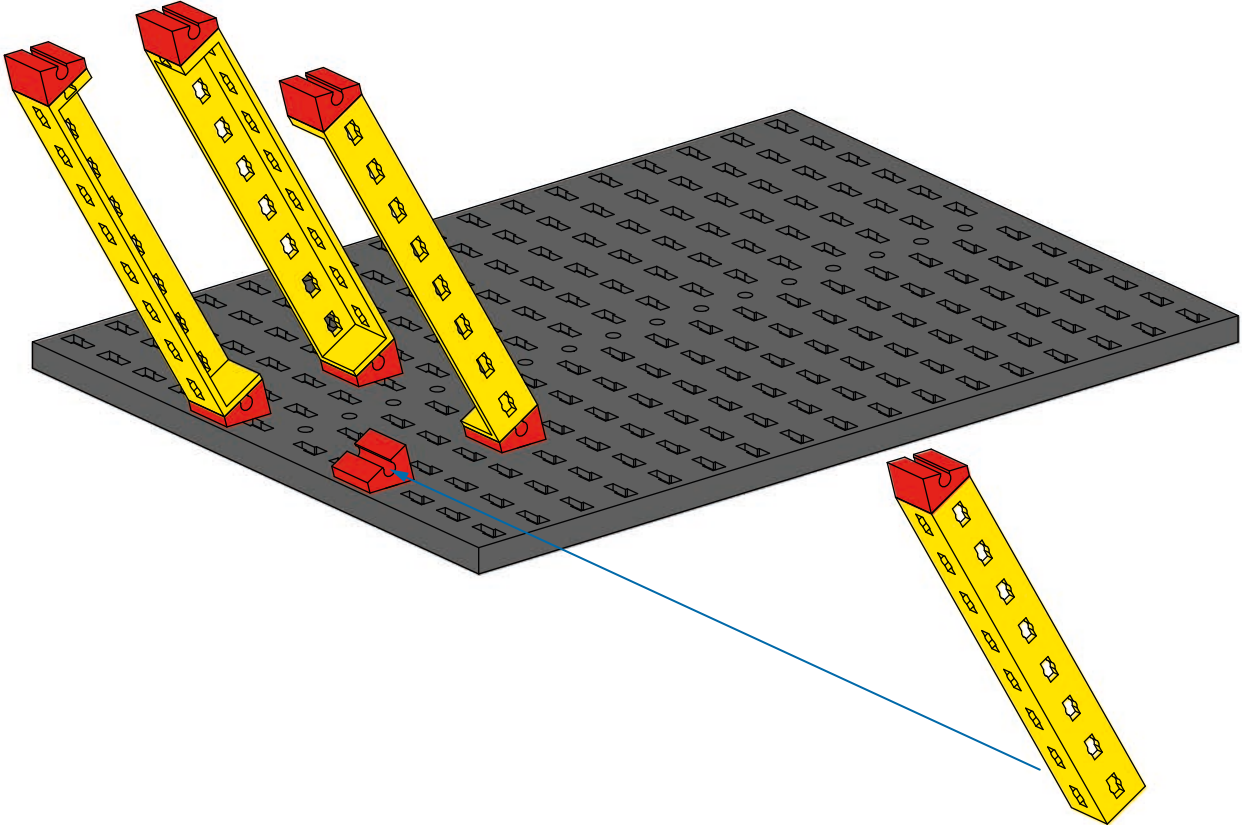
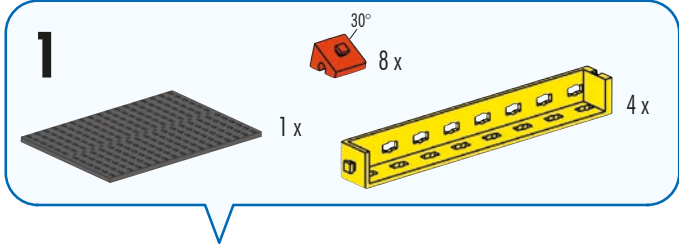

**3**

- 15 2x
- 2x
- 2x

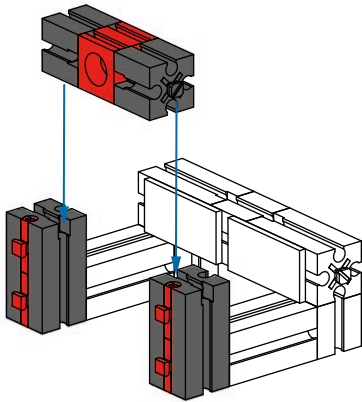
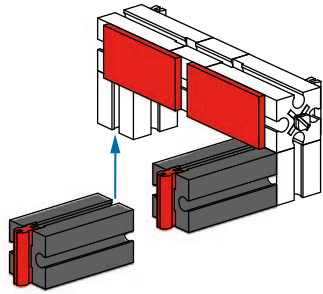

**4**

- 2x
- 4x
- 2x
- 1x

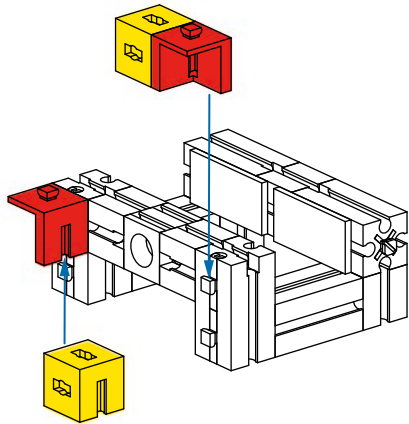

**5**

- 2x
- 2x

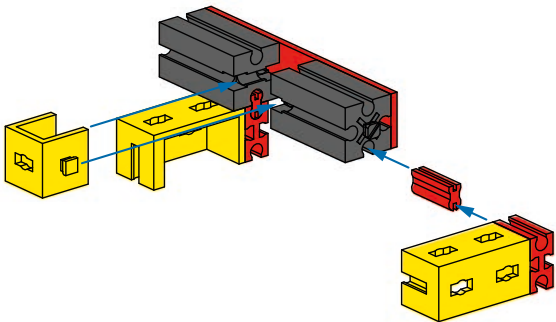

**6**

- 15 2x
- 2x
- 1x
- 2x
- 2x
- 1x

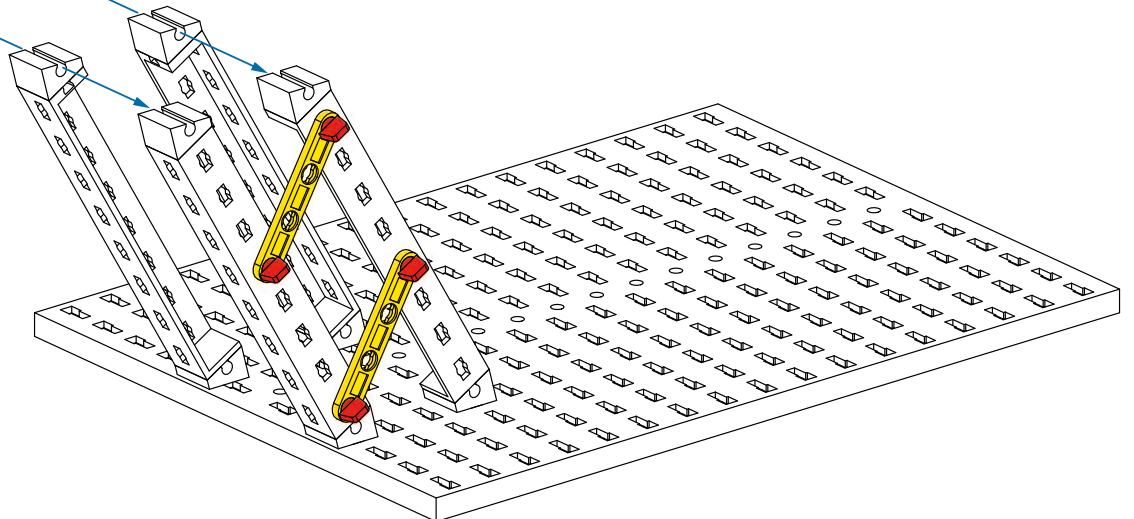
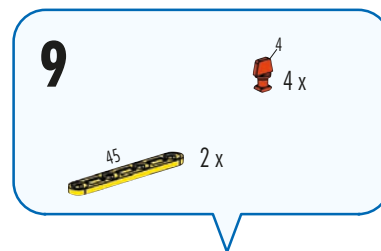
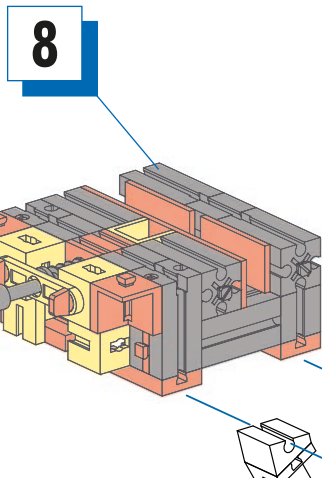
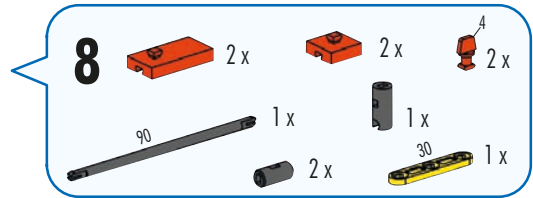
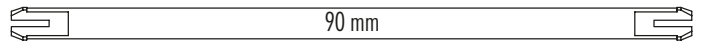
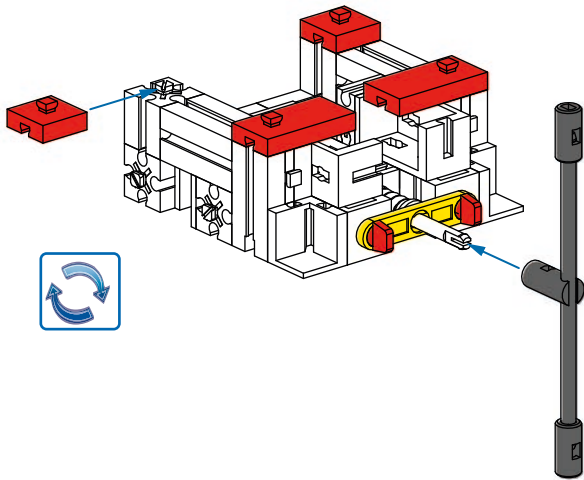
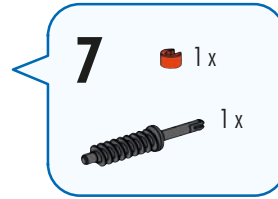
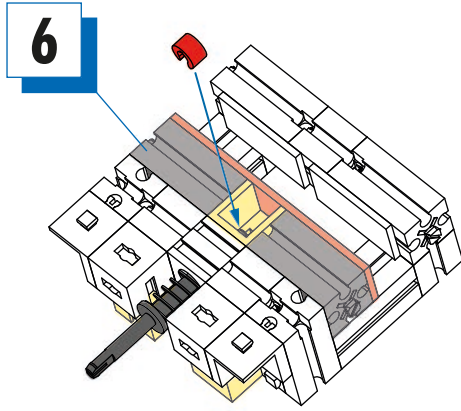

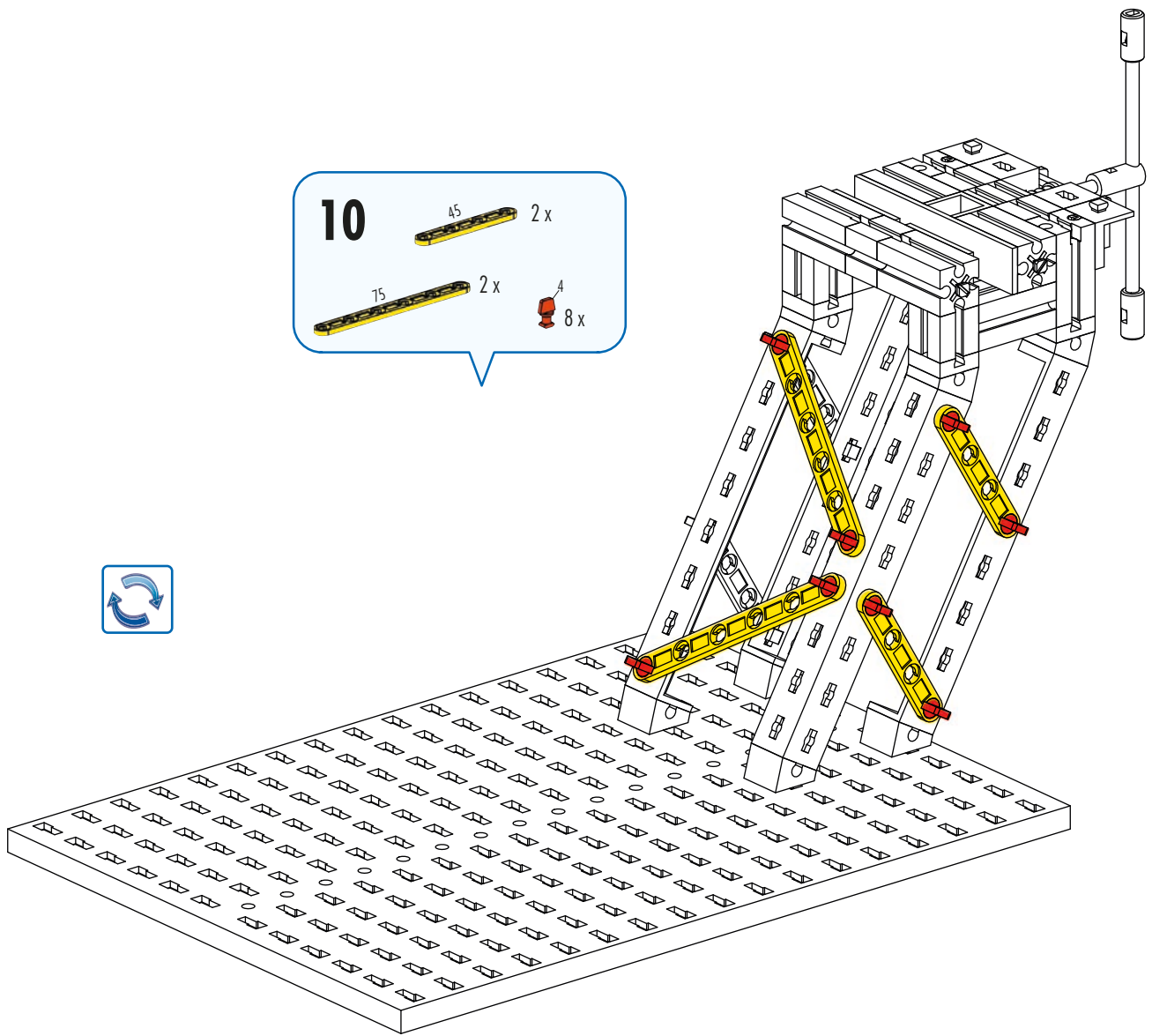

**10**

45 2 x

75 2 x

4 8 x

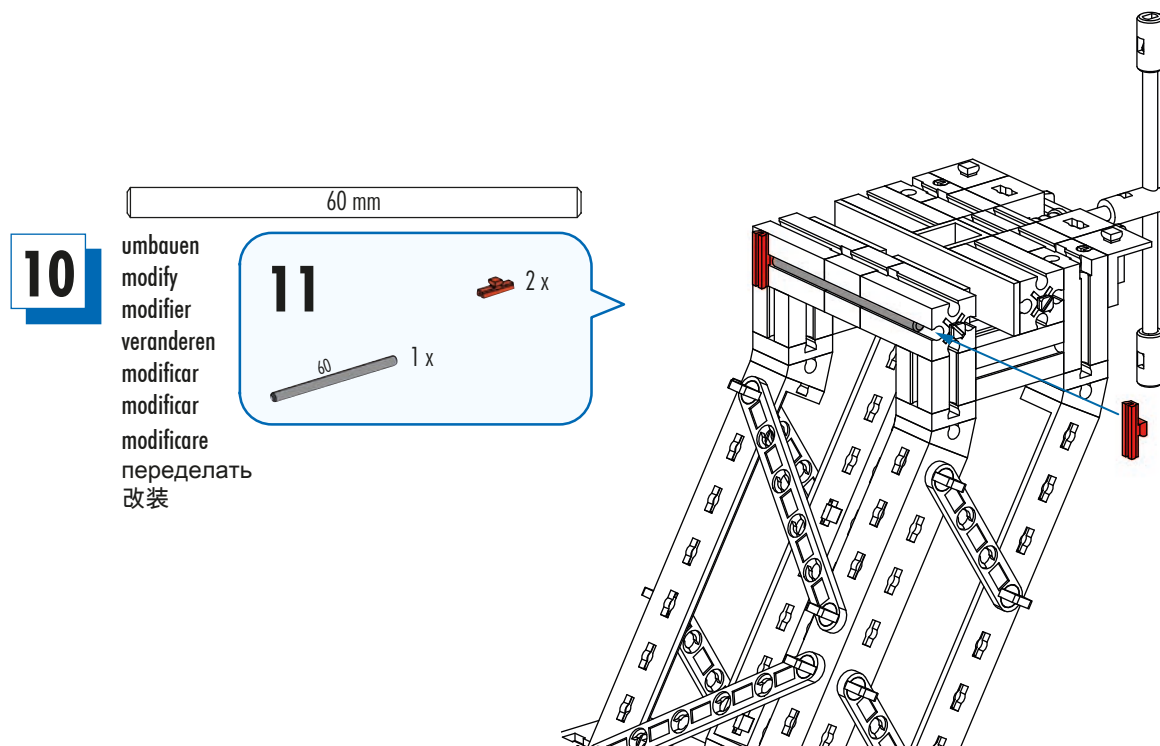

60 mm

**10**

umbauen  
 modify  
 modifier  
 veranderen  
 modificar  
 modifier  
 modificar  
 modificare  
 переделать  
 改装

**11**

60 1 x

4 2 x



**11**

umbauen  
modify  
modifier  
veranderen  
modificar  
modificar  
modificare  
переделать  
改装

**12**

30 2 x

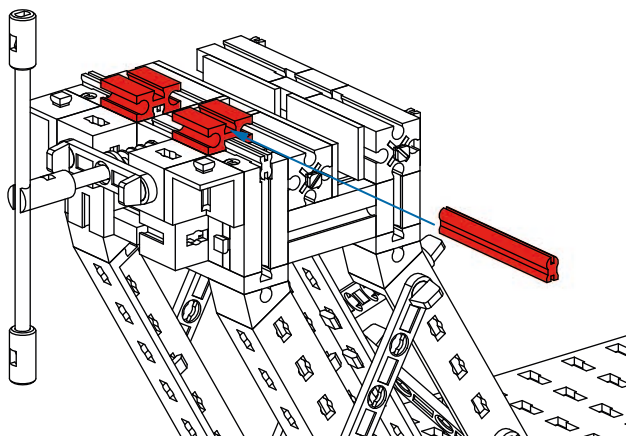
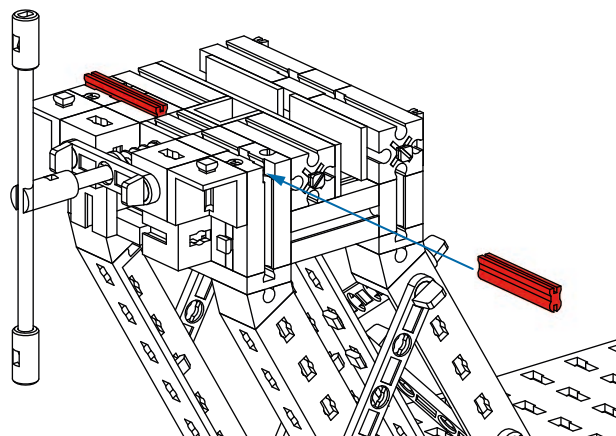

**12**

umbauen  
modify  
modifier  
veranderen  
modificar  
modificar  
modificare  
переделать  
改装

**13**

2 x

45 1 x

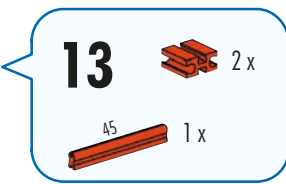

**13**

umbauen  
modify  
modifier  
veranderen  
modificar  
modificar  
modificare  
переделать  
改装

**14**

4 x

2 x

15 2 x

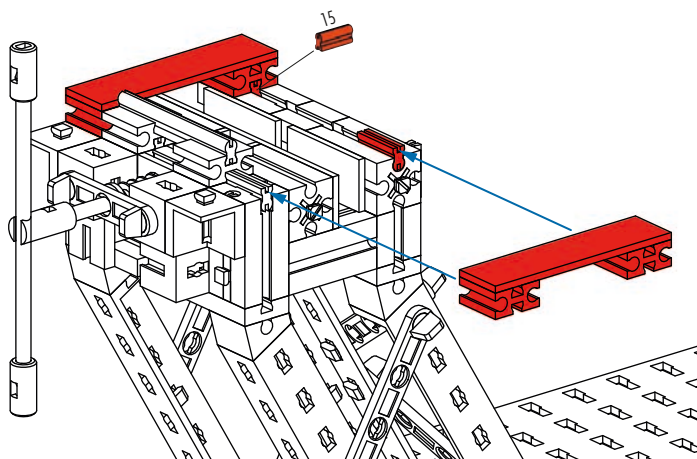
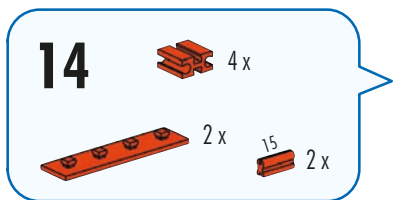

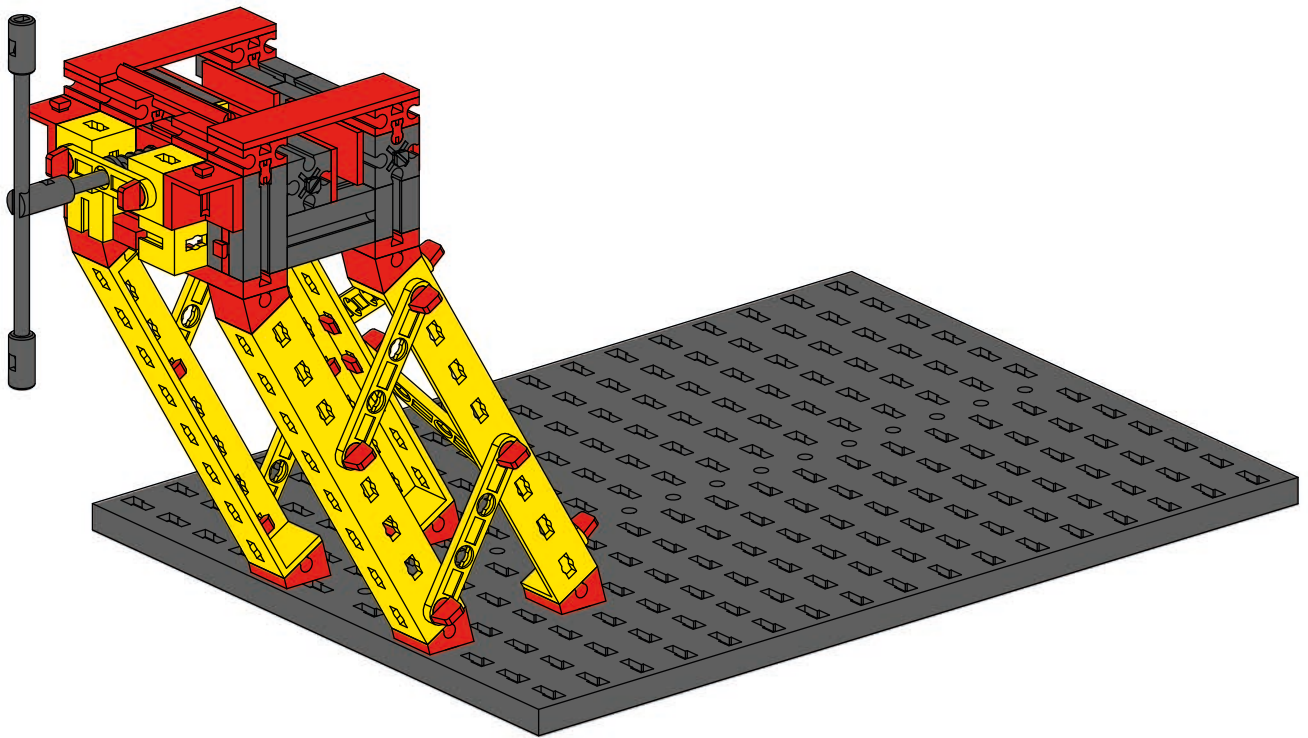



Schiefe Ebene  
Inclined plane  
Plan incliné

Hellend vlak  
Plano inclinado  
Plano inclinado

Piano inclinato  
Наклонная  
плоскость  
斜面

**1**

- 15 2 x
- 3 x
- 2 x

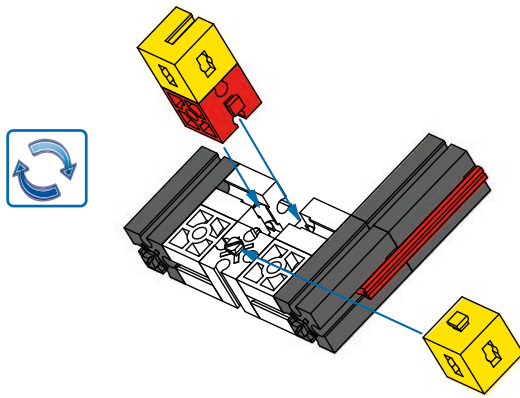
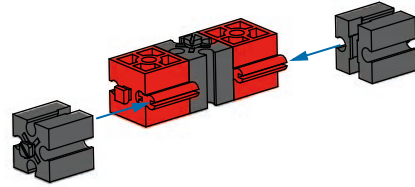

**2**

- 1 x
- 2 x
- 3 x
- 45 1 x

**3**

- 1 x
- 2 x
- 30° 2 x
- 4 x
- 2 x

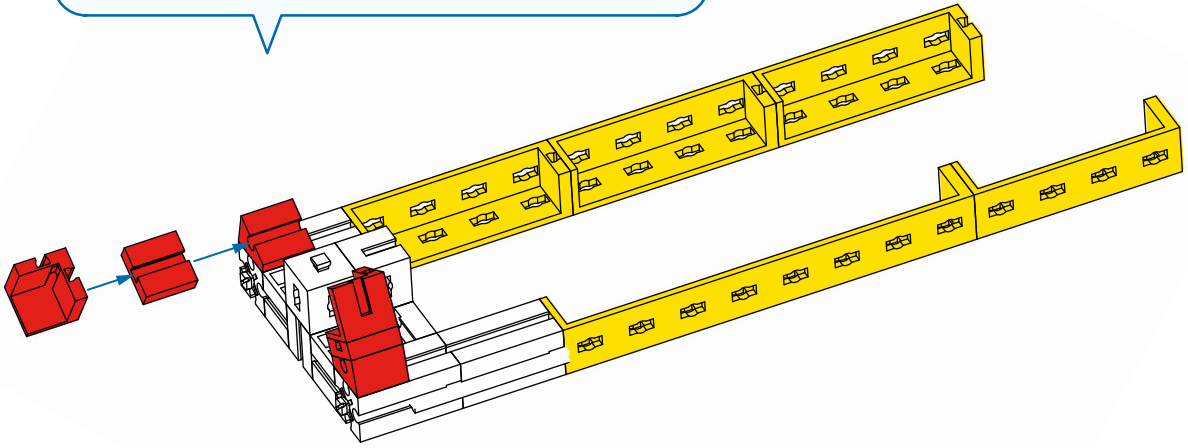
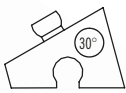

- 4**
- 2 x [Black Technic Pin]
  - 2 x [Yellow Technic Bracket]
  - 3 x [Yellow Technic Pin]

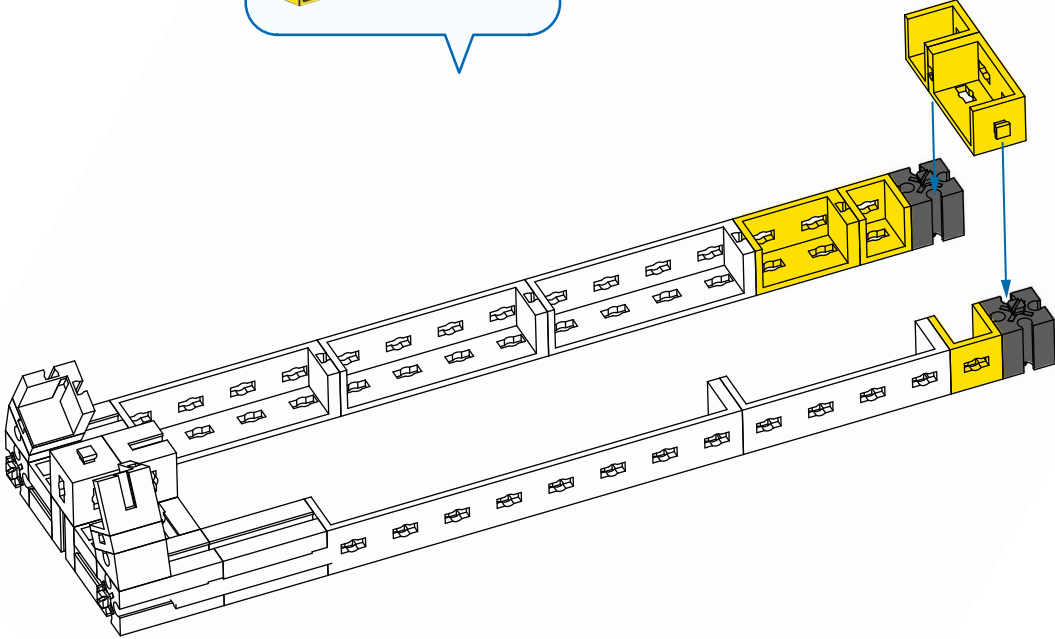

- 5**
- 4 x [Yellow Technic Beam]
  - 2 x [Red Technic Pin]
  - 2 x [Red Technic Pin, 30°]
  - 2 x [Red Technic Pin]
  - 1 x [Red Technic Pin]

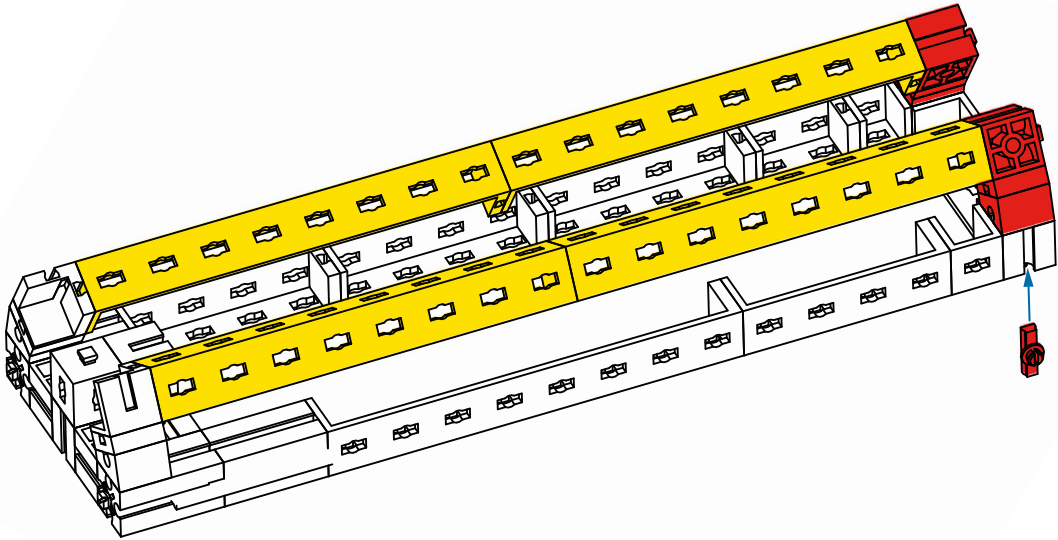
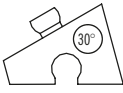

**6**

- 2 x (dark grey 1x2 Technic connector)
- 2 x (red 1x2 Technic connector)
- 1 x (yellow 1x2 Technic connector)
- 1 x (yellow 1x2 Technic connector with hole)
- 4 x (yellow 1x10 Technic beam)

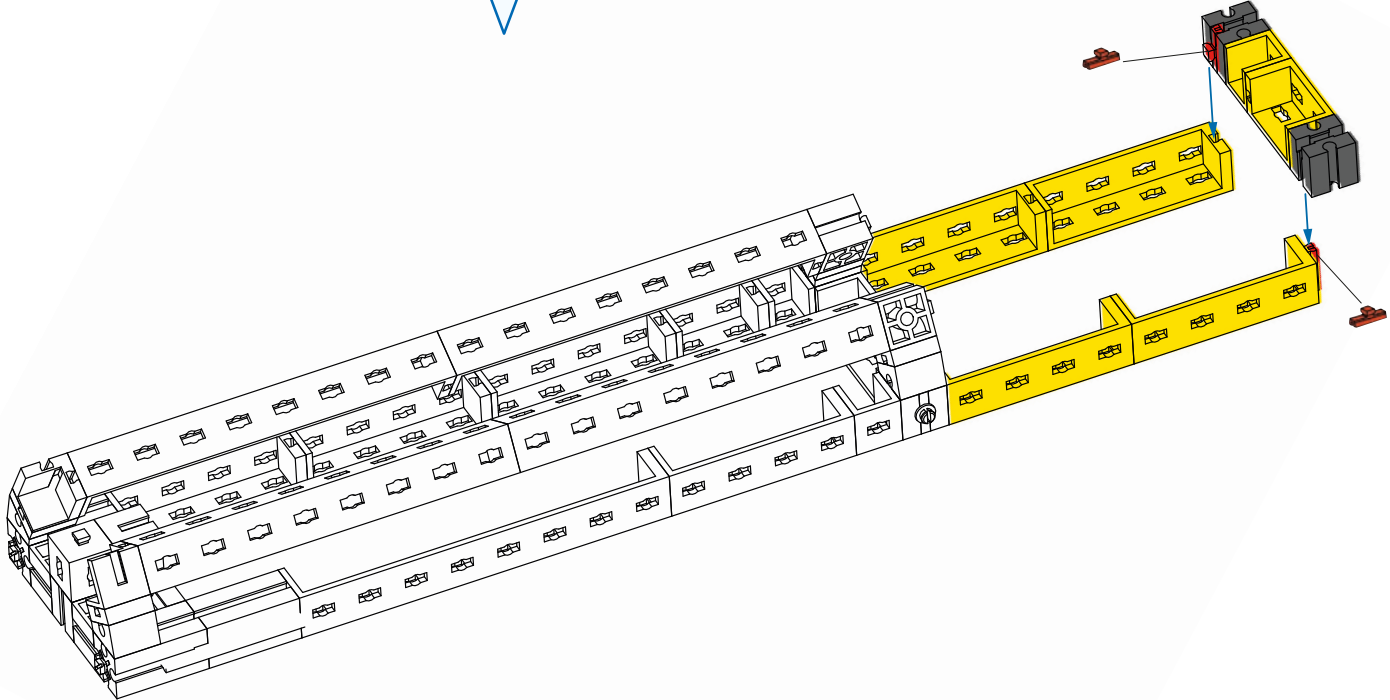



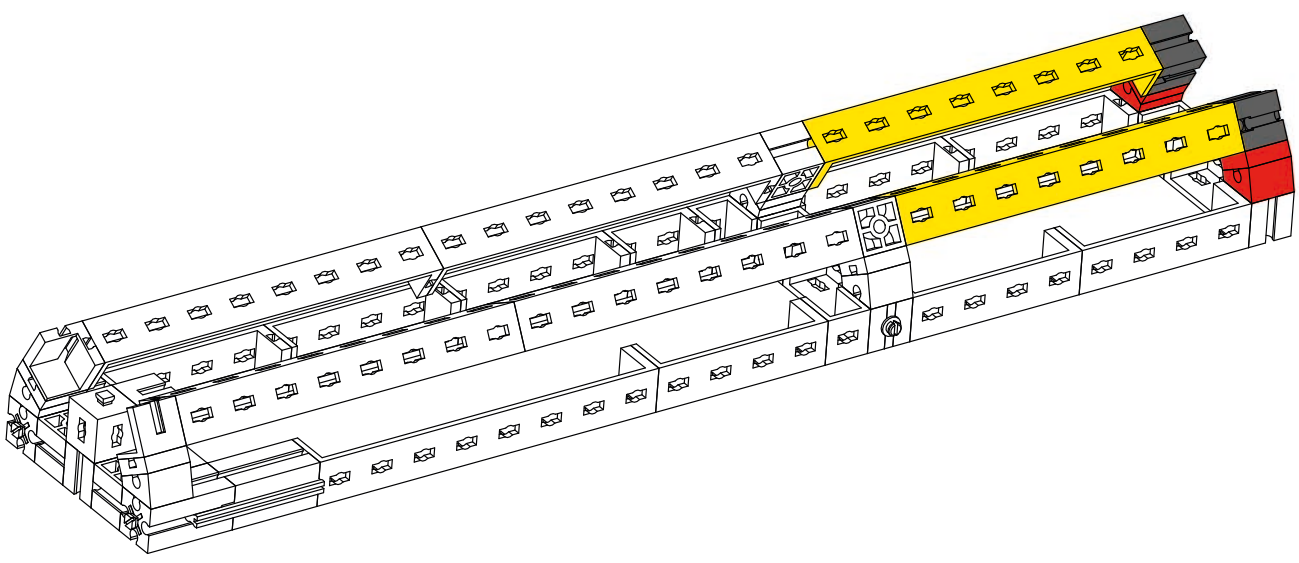

**7**

- 2 x (yellow 1x10 Technic beam)
- 2 x (red 30-degree Technic wedge)
- 2 x (dark grey 1x2 Technic connector)
- 2 x (red 1x2 Technic connector)



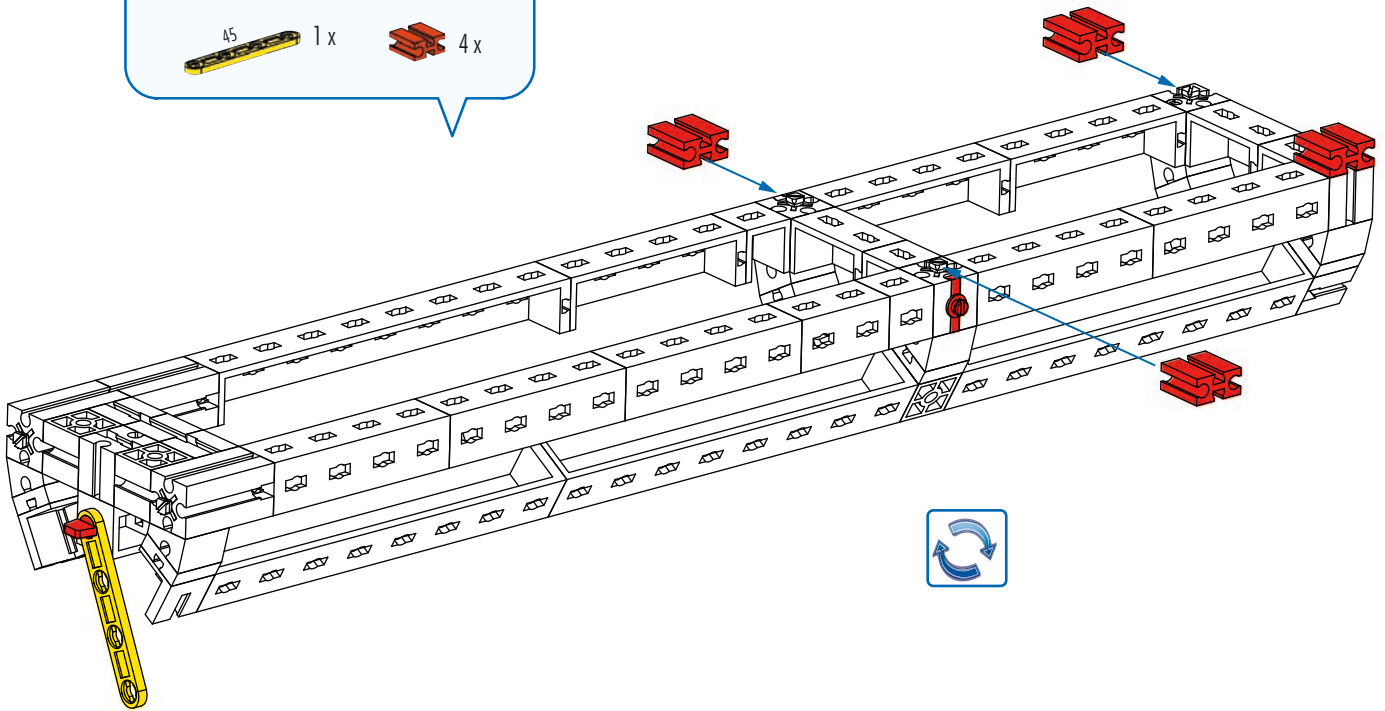

**8**

-  1 x
-  1 x
-  1 x
-  4 x





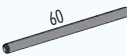

**9**

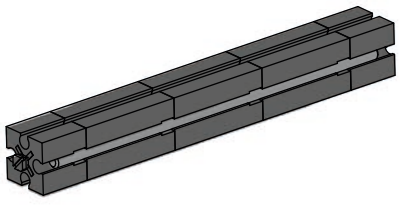
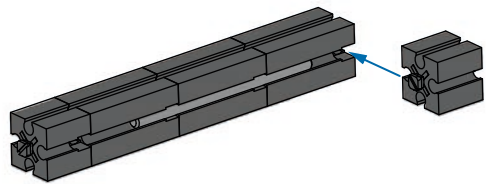
-  1 x
-  1 x
-  3 x
-  1 x

60 mm



**10**

-  1 x
-  1 x
-  3 x
-  1 x

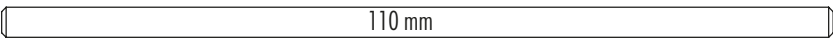

**11**

- 2 x
- 2 x
- 4 x

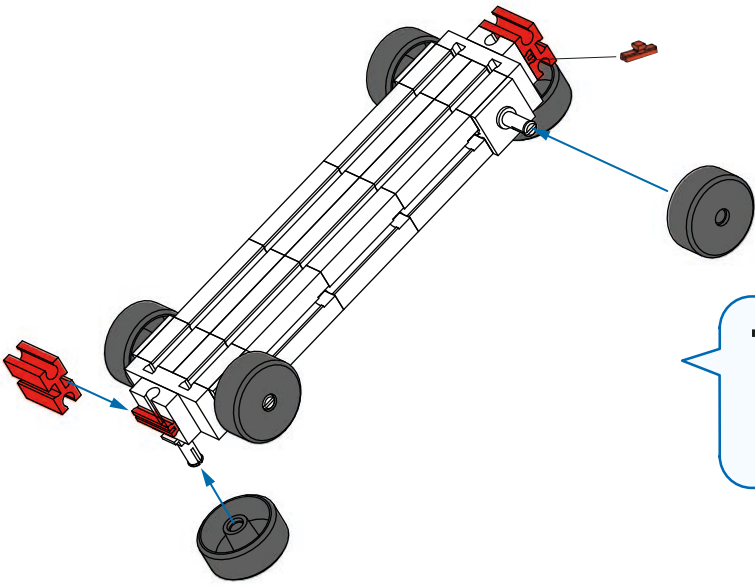
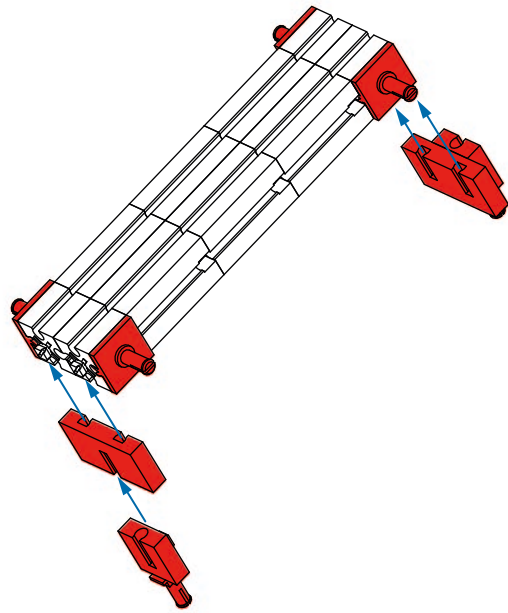

**12**

- 2 x
- 6 x
- 2 x

**13**

- 2 x
- 2 x
- 1 x
- 2 x

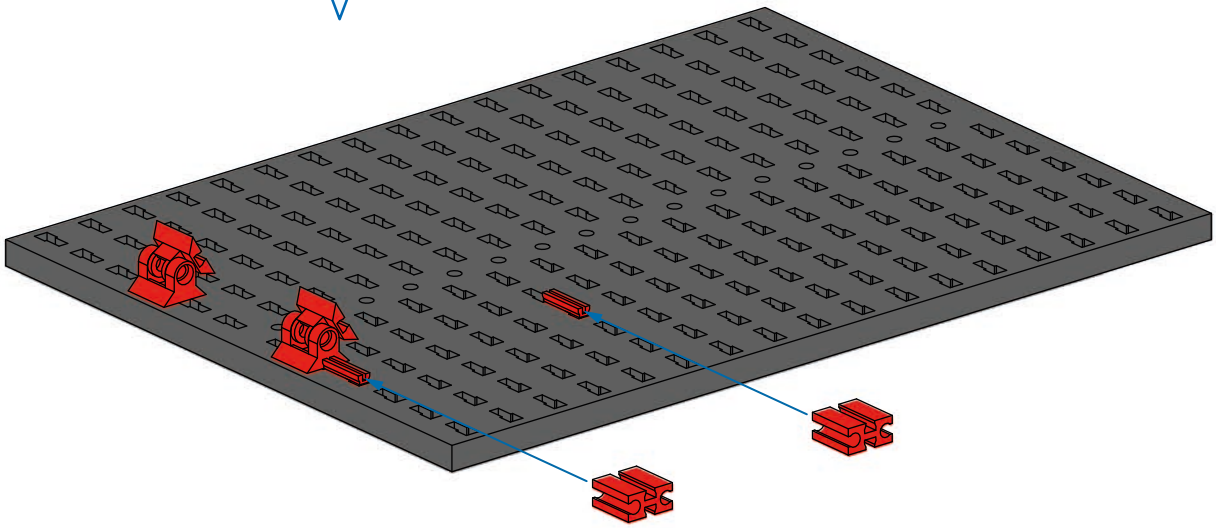

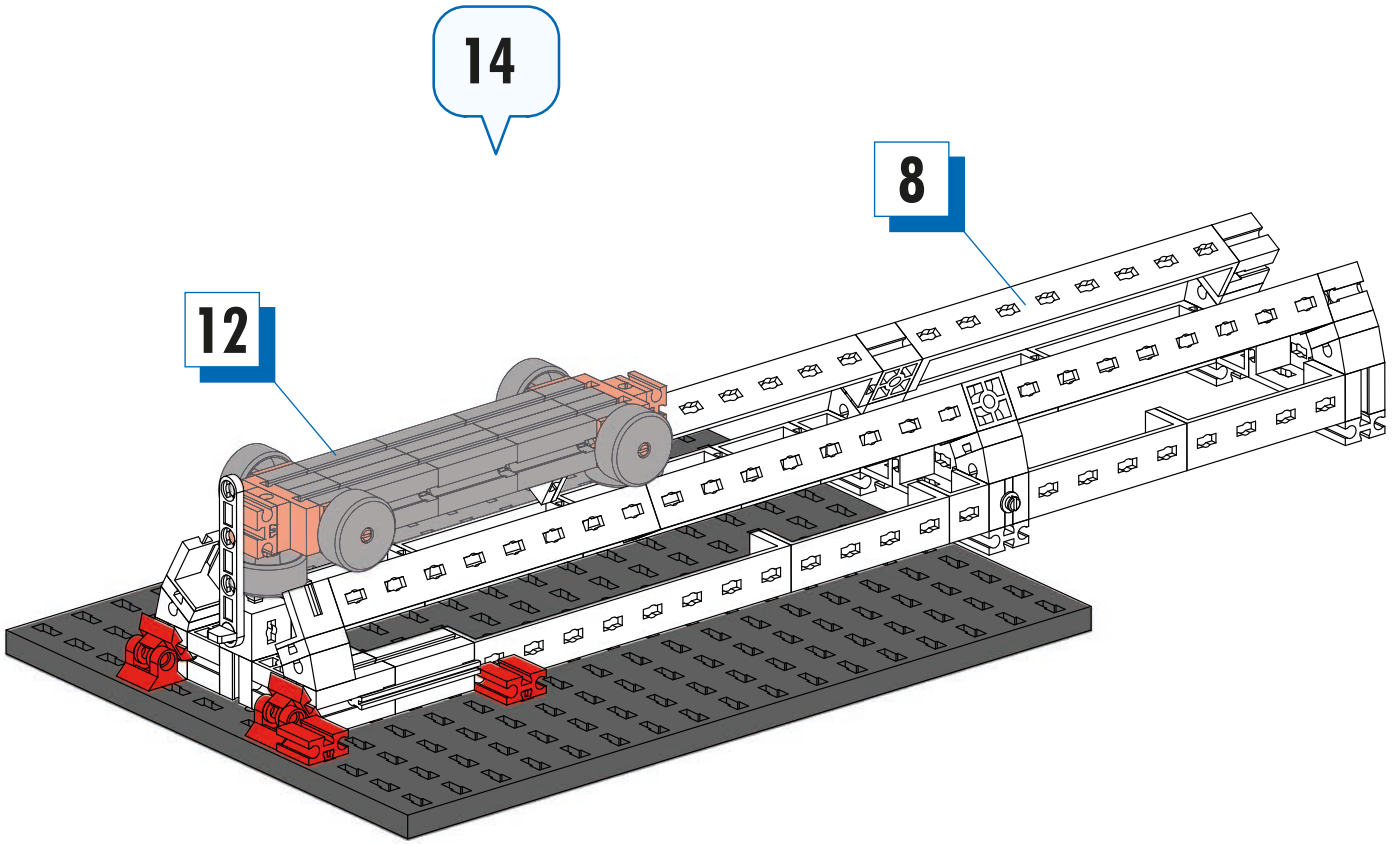

**15**

1x 1x 1x 1x

1x 1x 1x 1x

N	gf
0	0
0.5	50
1.0	100
1.5	150
2.0	200
2.5	250
3.0	300
3.5	350
4.0	400
4.5	450
5.0	500
5.5	550
6.0	600
6.5	650
7.0	700
7.5	750
8.0	800
8.5	850
9.0	900
9.5	950
10.0	1000
10.5	1050
11.0	1100
11.5	1150
12.0	1200
12.5	1250
13.0	1300
13.5	1350
14.0	1400
14.5	1450
15.0	1500
15.5	1550
16.0	1600
16.5	1650
17.0	1700
17.5	1750
18.0	1800
18.5	1850
19.0	1900
19.5	1950
20.0	2000
20.5	2050
21.0	2100
21.5	2150
22.0	2200
22.5	2250
23.0	2300
23.5	2350
24.0	2400
24.5	2450
25.0	2500
25.5	2550
26.0	2600
26.5	2650
27.0	2700
27.5	2750
28.0	2800
28.5	2850
29.0	2900
29.5	2950
30.0	3000
30.5	3050
31.0	3100
31.5	3150
32.0	3200
32.5	3250
33.0	3300
33.5	3350
34.0	3400
34.5	3450
35.0	3500
35.5	3550
36.0	3600
36.5	3650
37.0	3700
37.5	3750
38.0	3800
38.5	3850
39.0	3900
39.5	3950
40.0	4000
40.5	4050
41.0	4100
41.5	4150
42.0	4200
42.5	4250
43.0	4300
43.5	4350
44.0	4400
44.5	4450
45.0	4500
45.5	4550
46.0	4600
46.5	4650
47.0	4700
47.5	4750
48.0	4800
48.5	4850
49.0	4900
49.5	4950
50.0	5000
50.5	5050
51.0	5100
51.5	5150
52.0	5200
52.5	5250
53.0	5300
53.5	5350
54.0	5400
54.5	5450
55.0	5500
55.5	5550
56.0	5600
56.5	5650
57.0	5700
57.5	5750
58.0	5800
58.5	5850
59.0	5900
59.5	5950
60.0	6000
60.5	6050
61.0	6100
61.5	6150
62.0	6200
62.5	6250
63.0	6300
63.5	6350
64.0	6400
64.5	6450
65.0	6500
65.5	6550
66.0	6600
66.5	6650
67.0	6700
67.5	6750
68.0	6800
68.5	6850
69.0	6900
69.5	6950
70.0	7000
70.5	7050
71.0	7100
71.5	7150
72.0	7200
72.5	7250
73.0	7300
73.5	7350
74.0	7400
74.5	7450
75.0	7500
75.5	7550
76.0	7600
76.5	7650
77.0	7700
77.5	7750
78.0	7800
78.5	7850
79.0	7900
79.5	7950
80.0	8000
80.5	8050
81.0	8100
81.5	8150
82.0	8200
82.5	8250
83.0	8300
83.5	8350
84.0	8400
84.5	8450
85.0	8500
85.5	8550
86.0	8600
86.5	8650
87.0	8700
87.5	8750
88.0	8800
88.5	8850
89.0	8900
89.5	8950
90.0	9000
90.5	9050
91.0	9100
91.5	9150
92.0	9200
92.5	9250
93.0	9300
93.5	9350
94.0	9400
94.5	9450
95.0	9500
95.5	9550
96.0	9600
96.5	9650
97.0	9700
97.5	9750
98.0	9800
98.5	9850
99.0	9900
99.5	9950
100.0	10000

1x

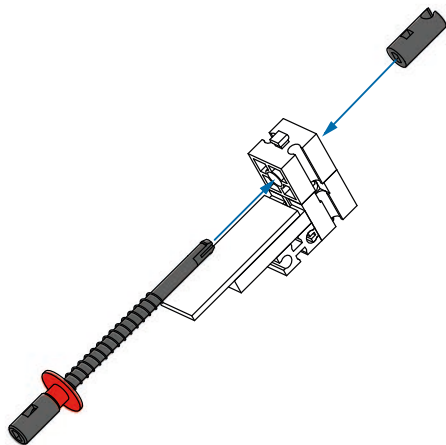
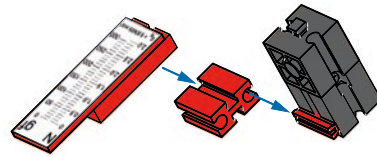

**16**

1x 1x 1x 1x

75

75 mm



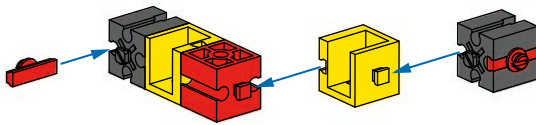



**17**

- 2x [Grey Technic Axle Connector]
- 2x [Red Technic Axle Connector]
- 2x [Yellow Technic 1x2 Brick]
- 1x [Red Technic 1x2 Brick]

**18**

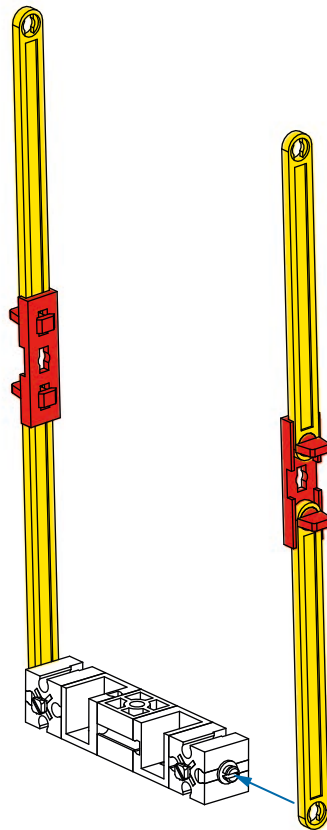
- 2x [Red Technic Axle Connector]
- 4x [Yellow Technic Axle, 64,8]
- 4x [Red Technic Pin, A]



**19**  1x  1x

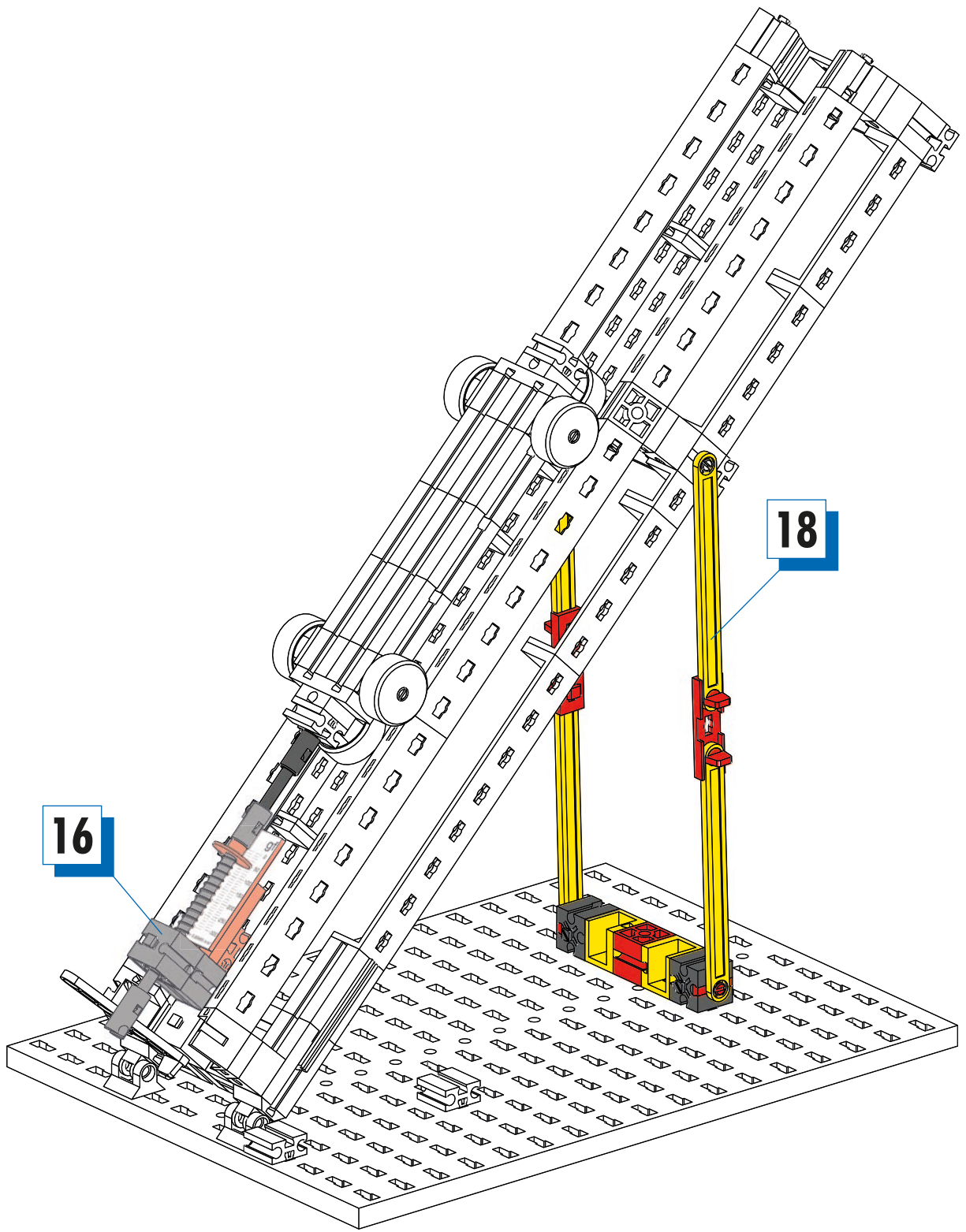

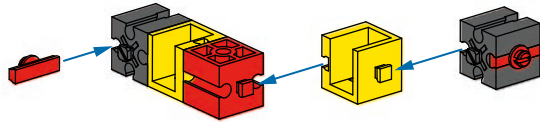

**20**

- 2 x
- 2 x
- 2 x
- 1 x

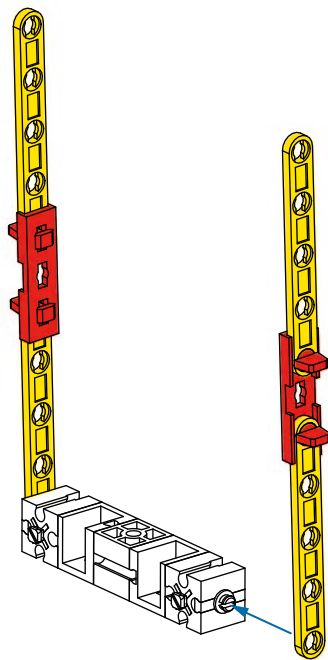

**21**

- 2 x
- 4 x
- 4 x

22

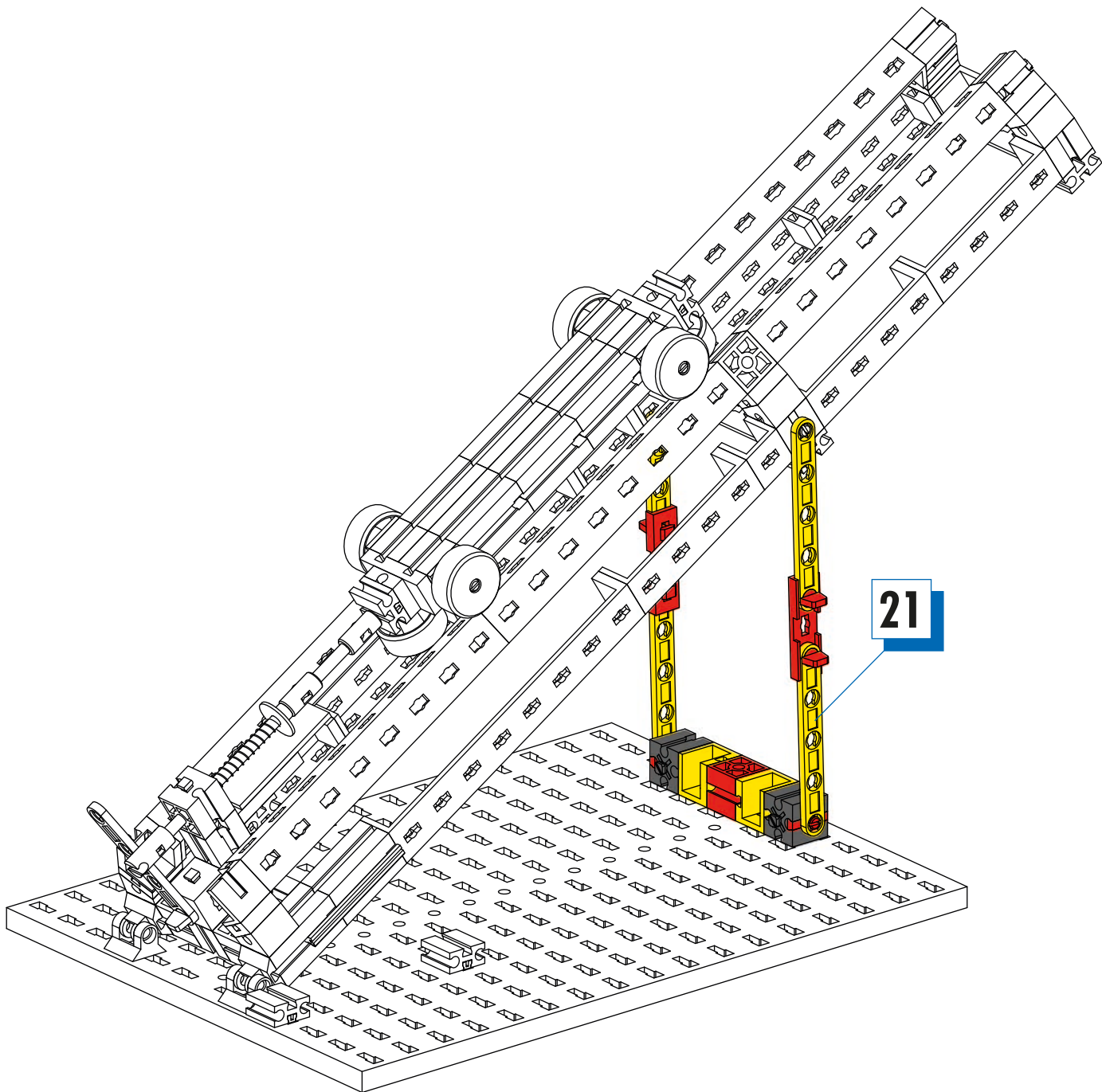

21

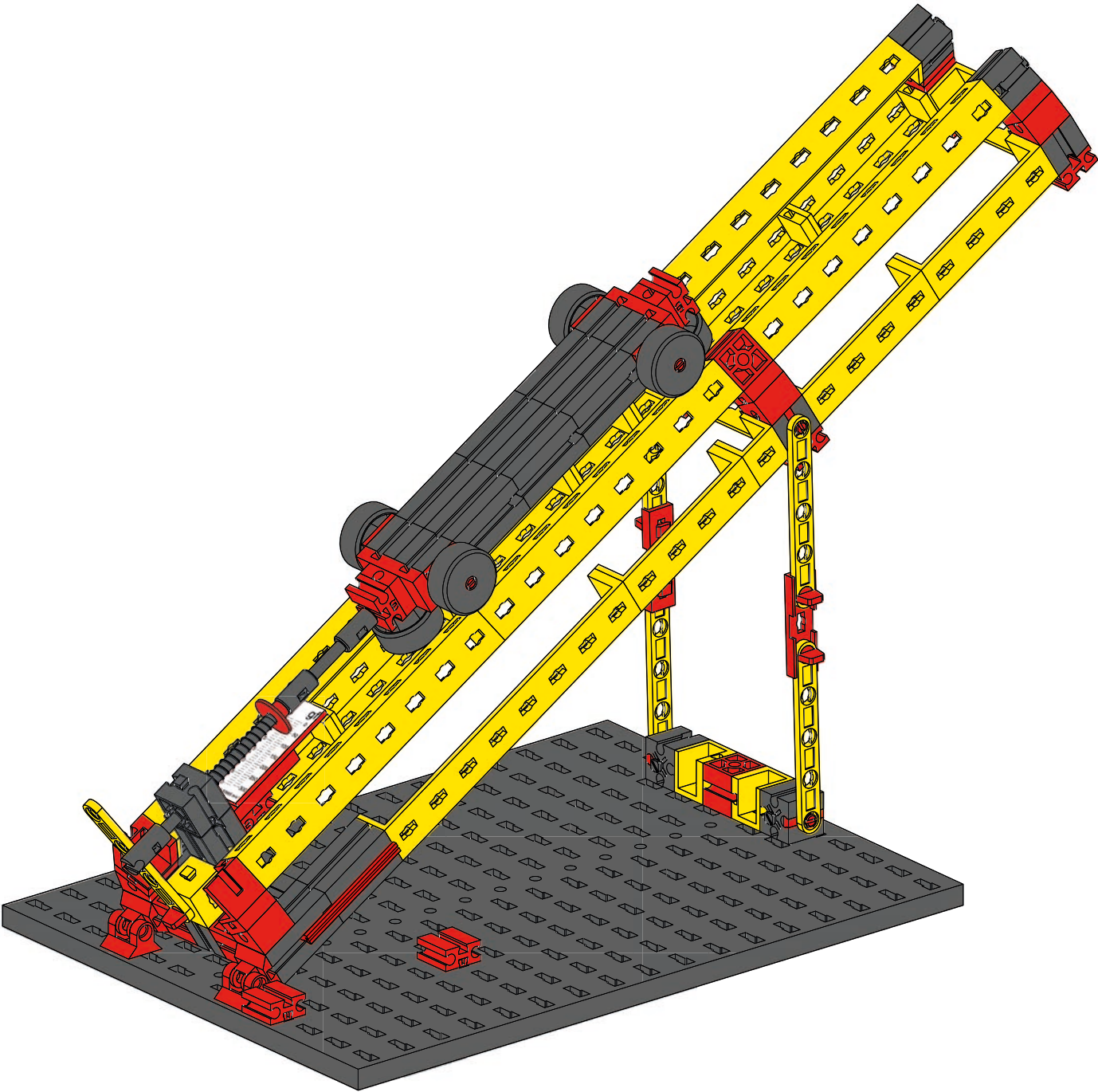

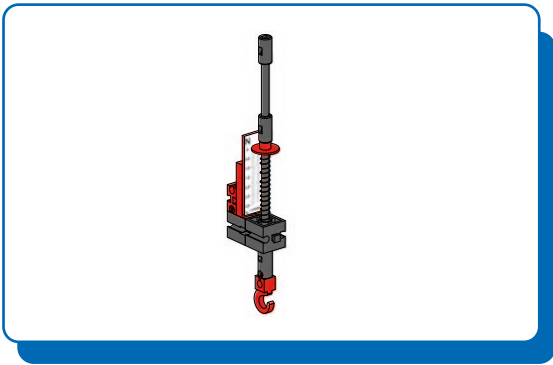







Federwaage  
Spring scale  
Balance à ressort

Lente schaal  
Báscula de resorte  
Escala de mola

Scala a molla  
пружинные весы  
春天的尺度





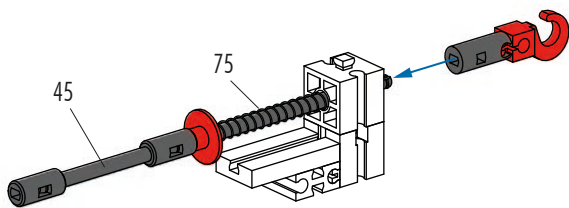
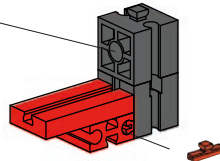

**1**

 1x
  1x
  1x
  1x
  1x

  
Große Bohrung  
Large drilling  
Alésage large  
Grote boring  
Perforación grande  
Orificio grande  
Grande foro  
Большое отверстие  
大孔



**2**

 1x
  1x
  2x
  1x
  1x
  1x
  1x

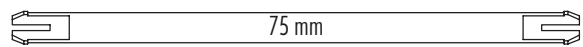
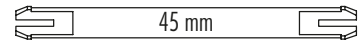

**3**



1 x

1 x

fiischertechnik

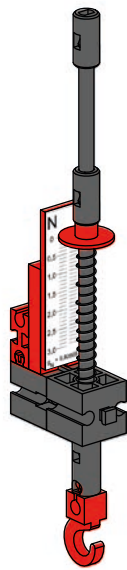
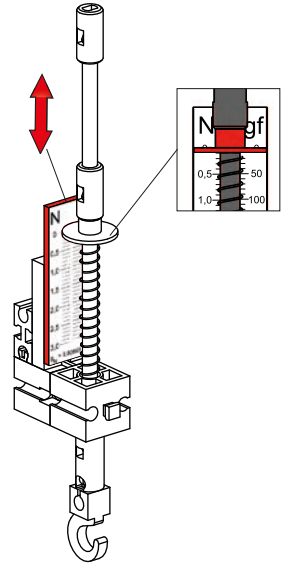

# STEM Simple Machines

fischertechnik GmbH  
Klaus-Fischer-Str. 1  
72178 Waldachtal  
Germany  
Phone: +49 74 43/12-43 69  
Fax: +49 74 43/12-45 91  
info@fischertechnik.de  
www.fischertechnik.de



190 834 · 07/22 · Co · Printed in Germany · Technische Änderungen vorbehalten · Subject to technical modifications

**S T E M** M A T H E M A T I K  
I N F O R M A T I K  
N A T U R W I S S E N S C H A F T  
T E C H N I K

 SCIENCE  TECHNOLOGY  ENGINEERING  MATHEMATICS

# 14 Models