

B A U A N L E I T U N G

FAN-CLUB

Nr. 5
ZUM SAMMELN

Bauvoraussetzung für den Radar-Truck sind ein CARTECH- und ein MASTER-Baukasten.













































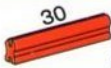













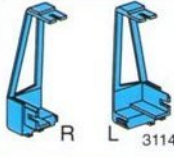













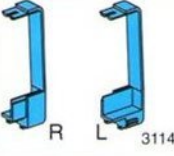



























CLUBMODELL: RADAR-TRUCK

Die Modellidee könnt Ihr bestimmt auch verwirklichen, wenn Ihr nicht alle angegebenen Baukästen habt. Seht einfach in die Stückliste - und wenn Euch ein paar Teile fehlen, dann baut Ihr Euren eigenen Radar-Truck. Wenn's gar nicht ohne Zusatzteile geht, gibt's die SUPER-SERVICE-Stationen oder den fischertechnik Einzelteil-Service, Tel. 0 74 43/12-490, Fax 0 74 43/12-591



fischertechnik® 

Einzelteilübersicht

	Master/ Master Discovery	Cartech		Master/ Master Discovery	Cartech		Master/ Master Discovery	Cartech		Master/ Master Discovery	Cartech		Master/ Master Discovery	Cartech
	31010	2x		31764	2x		32856	2x		35064	1x		37238	5x
	31011	8x		31766	2x		32858	4x		35065	1x		37384	1x
	31019	1x		31843	2x		32859	2x		35066	1x		37468	4x
	31031	2x		31888	2x		32860	2x		35073	2x		37636	7x
	31032	1x		31894	2x		32861	2x		35414	2x		37679	5x
	31058	1x		31915	1x		32869	1x		35797	1x		38225	1x
	31060	2x		31916	1x		32870	2x		35971	2x		38240	4x
	31061	5x		31981	4x		32879	4x		35972	1x		38242	1x
	31078	1x		31982	6x		32881	8x		35979	2x		38260	2x
	31082	1x		31997	2x		32882	3x		35998	2x		38267	1x
	31140	1x		31998	2x		32883	4x		36026	1x		38277	2x
	31140	1x		31999	2x		32884	1x		36210	1x		38324	4x
	31142	1x		32064	3x		32885	1x		36294	8x		38416	2x
	31144	1x		32071	1x		32886	1x		36297	8x		38423	2x
	31144	1x		32233	1x		32887	2x		36298	2x		38428	2x
	31426	2x		32263	1x		32913	4x		36299	4x		38541	1x
	31436	2x		32293	1x		32958	1x		36323	42x		38542	14x
	31614	1x		32627	4x		35031	1x		36334	6x		38544	1x
	31667	2x		32850	6x		35049	3x		36708	1x		38545	2x
	31674	2x		32852	1x		35061	1x		37232	4x			
	31690	1x		32854	2x		35062	1x		37237	14x			

5

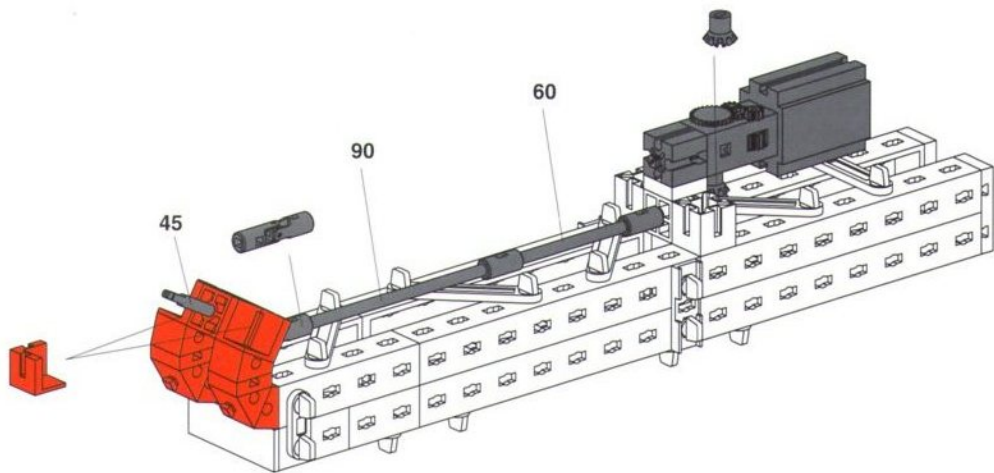

6

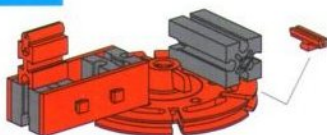

7

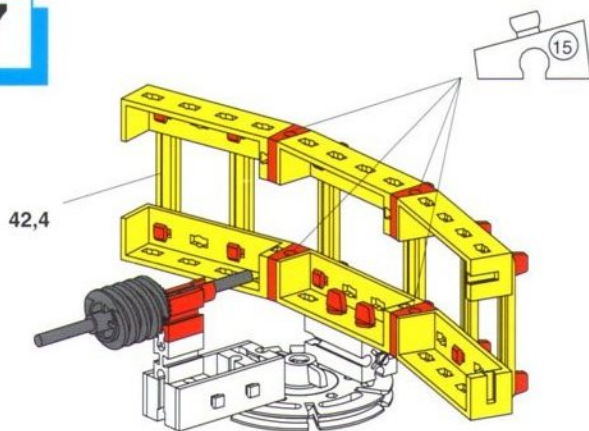

8

