

B A U A N L E I T U N G

# FAN-CLUB

**Nr. 6**  
ZUM SAMMELN

## CLUBMODELL: SPACE-GLIDER

Bauvoraussetzung für unseren „Space-Glider“ sind ein MASTER- und ein GALAXY-Baukasten.



































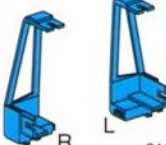























































Die Modellidee könnt Ihr bestimmt auch verwirklichen, wenn Ihr nicht alle angegebenen Baukästen habt. Seht einfach in die Stückliste – und wenn Euch ein paar Teile fehlen, dann baut Ihr Euren eigenen Space-Glider. Wenn's gar nicht ohne Zusatztteile geht, gibt's die SUPER-SERVICE-Stationen oder den fischertechnik Einzelteil-Service, Tel. 0 74 43/12-490, Fax 0 74 43/12-591

**fischertechnik**®





# Einzelteilübersicht

	Master/ Master Discovery	Master Plus Galaxy		Master/ Master Discovery	Master Plus Galaxy		Master/ Master Discovery	Master Plus Galaxy		Master/ Master Discovery	Master Plus Galaxy
 31010	2x	4x	 32316	2x	 35064	1x	 36324	4x	 38267	3x	
 31011	8x	6x	 32850	6x	8x  35065	2x	 36334	6x	 38277	2x	
 31023	1x		 32854	2x	 35066	2x	 36701	4x	 38324	2x	
 31060	2x		 32856	2x	 35071	2x	 36702	2x	 38416	2x	
 31061	1x		 32860	2x	 35073	3x	 36817	3x	 38423	2x	2x
 31140	1x		 32861	3x	 35076	4x	 36818	2x	 38422	2x	9x
 31142	1x		 32870	2x	2x  35087	2x	 36819	11x	 38531	4x	
 31426	2x	2x	 32871	1x	 35112	1x	 37237	14x	2x  38538	2x	
 31436	2x	13x	 32879	4x	 35945	5x	 37468	4x	2x  38541	2x	
 31667	2x		 32880	2x	 35973	2x	 37527	2x	 38544	1x	1x
 31766	2x		 32881	8x	6x  35977	2x	 37679	8x	 38545	1x	
 31843	2x		 32882	4x	3x  35979	2x	 37858	1x			
 31848	2x		 32883	4x	 35998	2x	 37925	1x			
 31905	1x		 35049	2x	 36227	2x	 37926	3x			
 31909	1x		 35050	3x	 36248	24x	 38240	4x	8x		
 31981	2x		 35053	18x	 36294	8x	 38242	1x			
 13982	4x		 35060	2x	 36297	8x	3x  38244	2x			
 31983	2x		 35061	2x	 36298	2x	1x  38245	2x			
 31994	2x		 35062	3x	 36299	4x	 38251	4x			
 32064	3x	12x	 35063	3x	 36323	42x	 38253	2x			

# Space – Glider

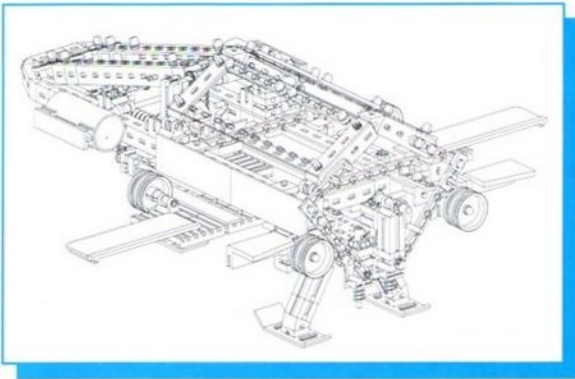

1

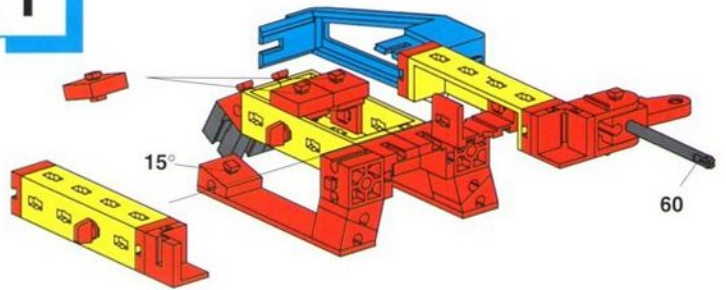

2

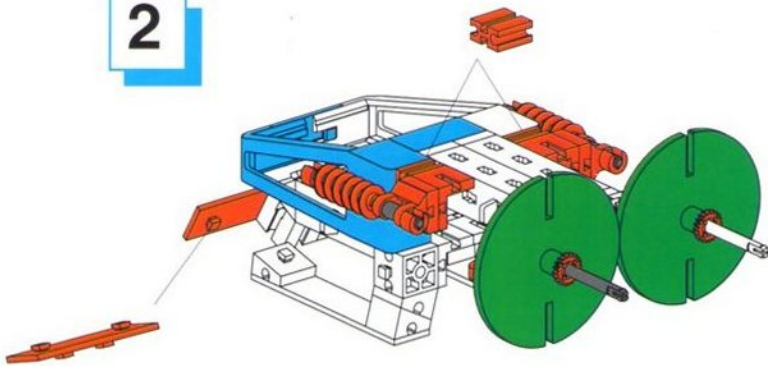

3

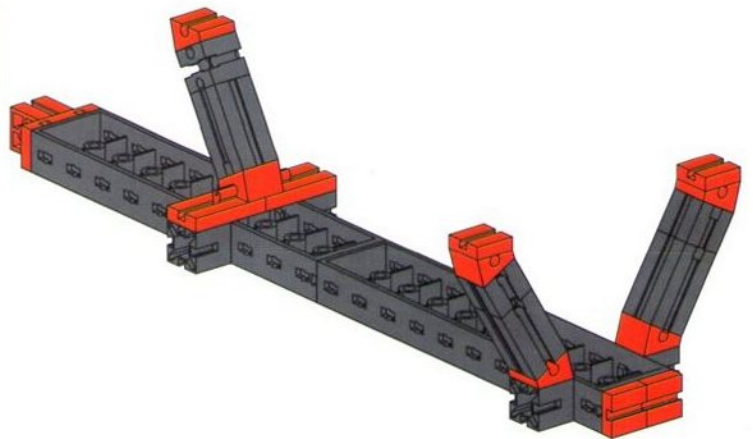

4

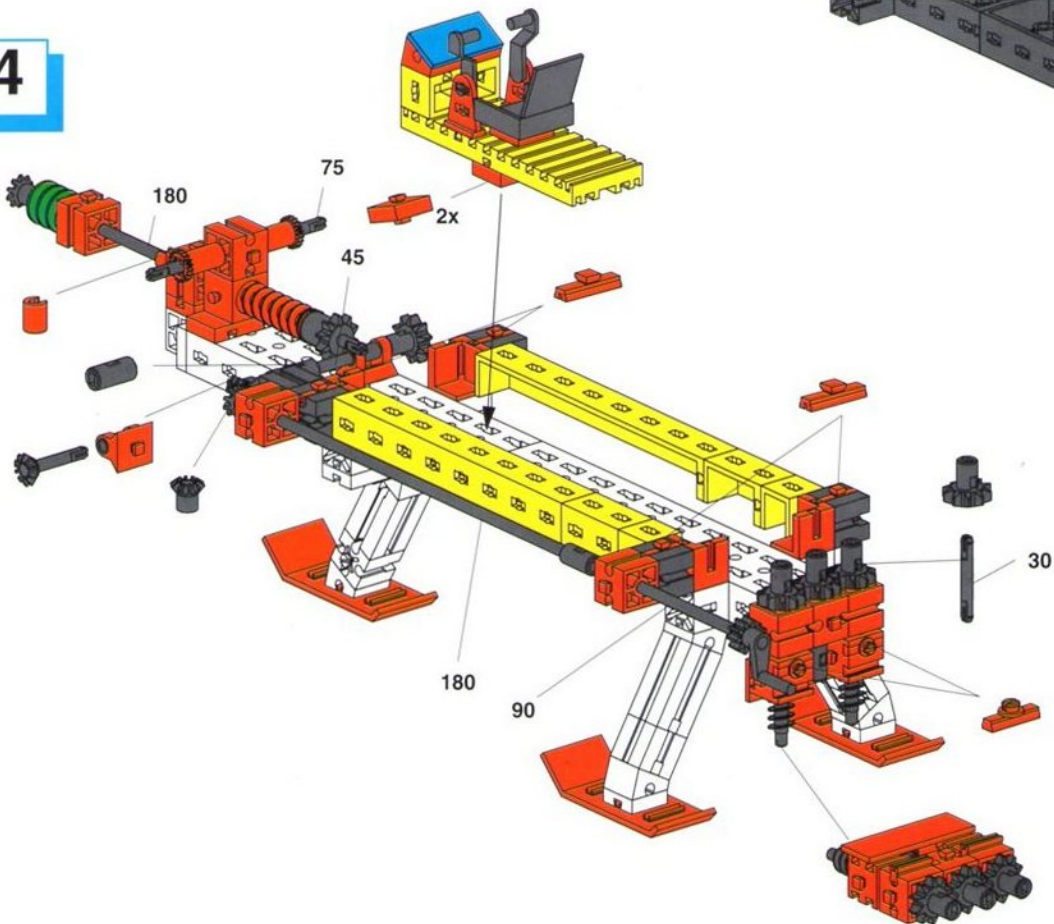



5

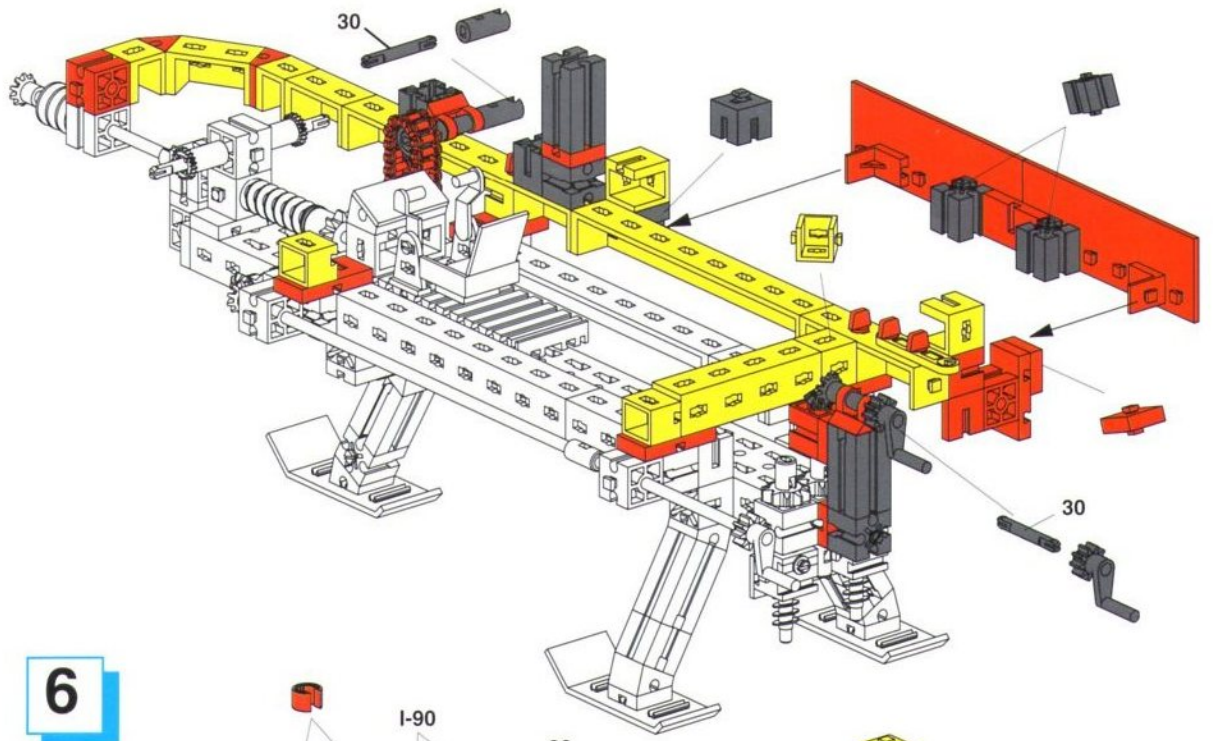

6

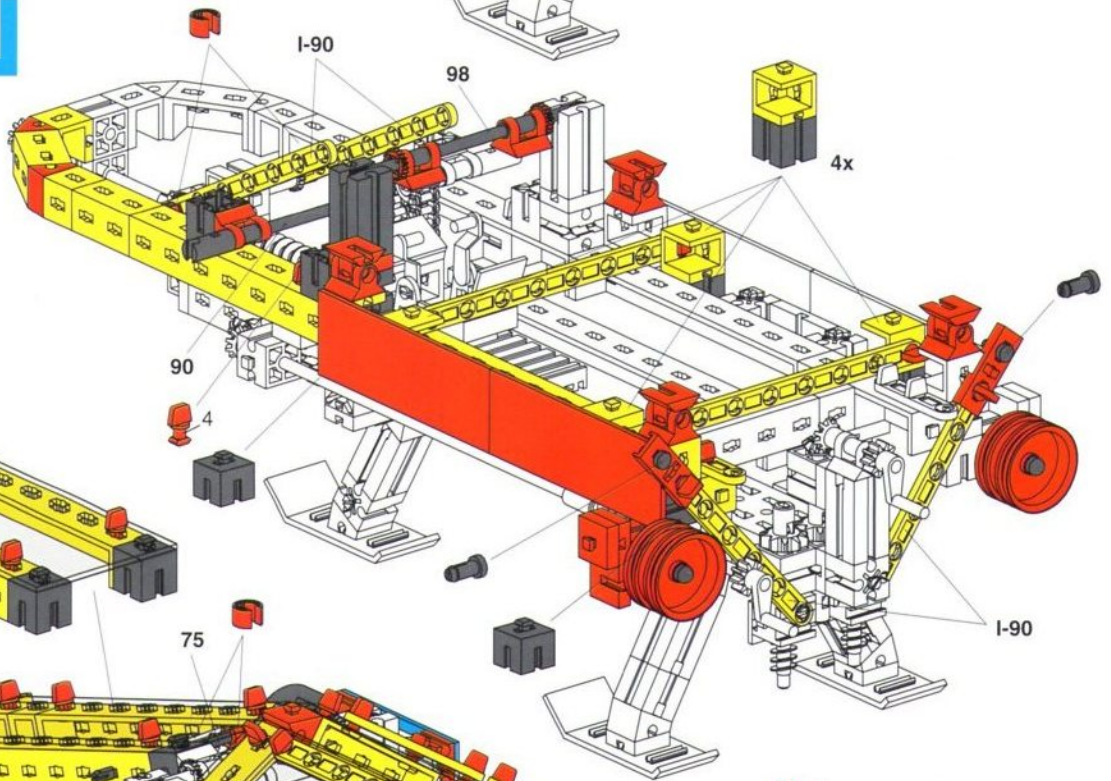

7

