

# Little Starter

fischertechnik 

Junior

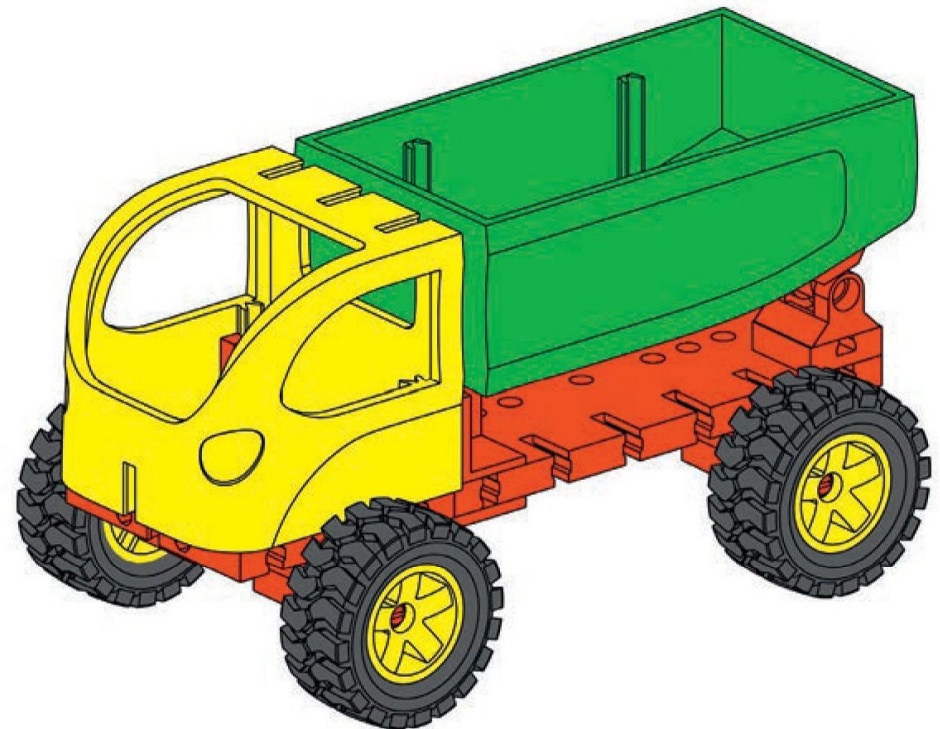

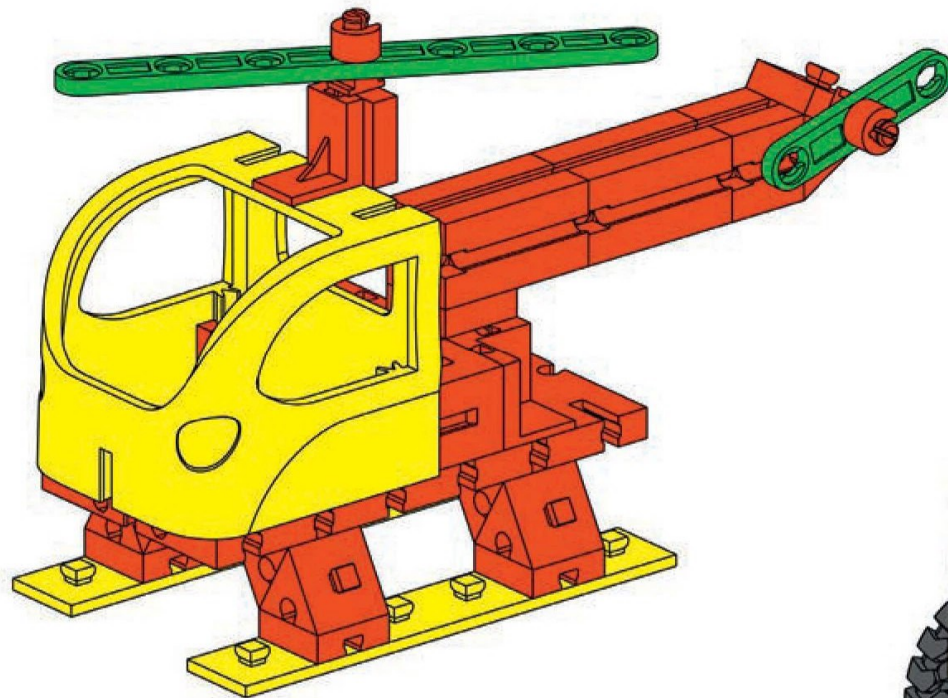
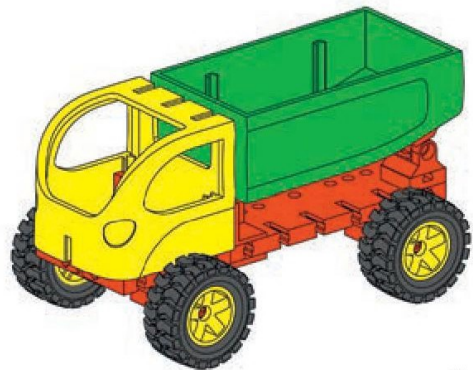

.....2

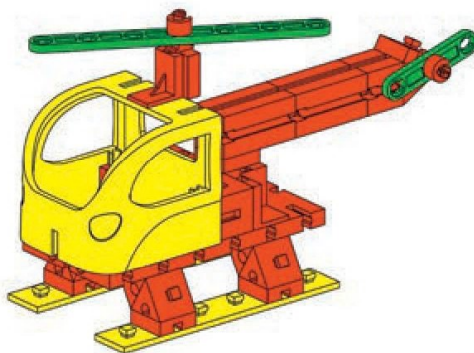

.....6

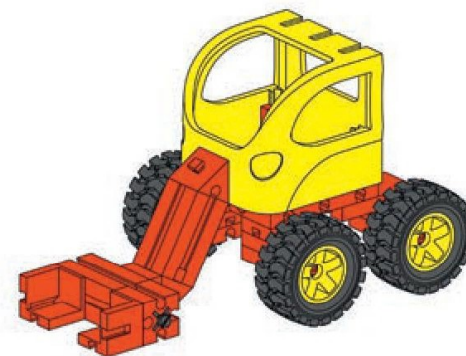

.....10

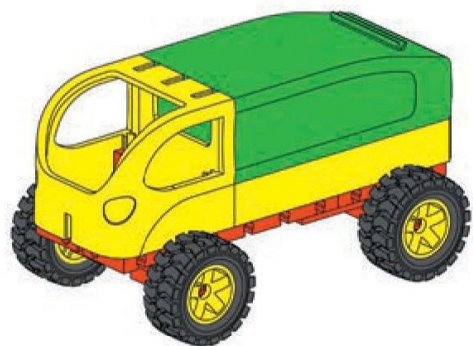



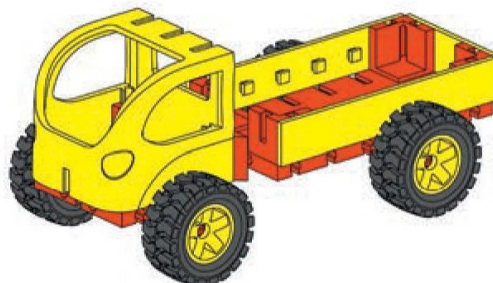



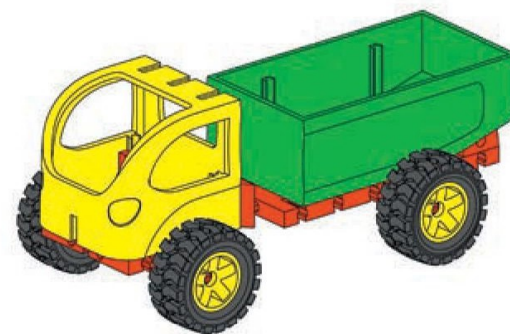







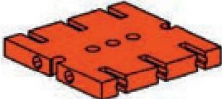

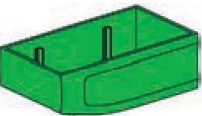

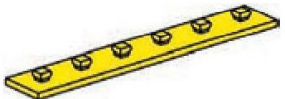

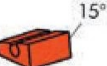

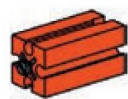
.....14



.....18

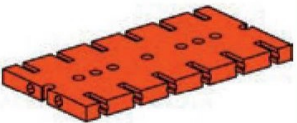

.....22

	31 010 9 x		36 586 4 x		38 243 1 x		142 253 1 x
	31 426 2 x		36 593 1 x		38 423 3 x		142 297 1 x
	31 436 2 x		37 237 6 x		38 486 2 x		143 235 1 x
	31 981 2 x		37 238 1 x		116 251 2 x		143 236 1 x
	32 064 1 x		37 679 2 x		116 252 1 x		
	35 049 2 x		38 240 4 x		142 251 4 x		
	36 576 1 x		38 241 2 x		142 252 4 x		

- Alle Einzelteile, insbesondere bewegliche Teile sind falls notwendig zu warten und zu reinigen.
- All components, especially moving parts, should be maintained and cleaned as necessary.
- Toutes les pièces détachées et en particulier les pièces mobiles, sont, si nécessaire, à entretenir et à nettoyer.
- Alle onderdelen, vooral de bewegende delen, kunnen, indien noodzakelijk, onderhouden en gereinigd worden.
- Es necesario limpiar y mantener en buen estado todas las diferentes piezas - especialmente las piezas móviles.

- Caso necessário, todas as peças individuais, especialmente peças móveis, tem que ser submetidas à manutenção e ser limpadas.
- Se necessario, tutti i singoli componenti, soprattutto le parti mobili, si devono eventualmente sottoporre a manutenzione e pulizia.
- Все детали, особенно подвижные, требуют ухода и чистки.
- 必要时应保养和清洁所有零件，尤指运动部件。



fischertechnik GmbH  
Klaus-Fischer-Straße 1  
72178 Waldachtal  
Germany

Phone +49 74 43/12-43 69  
Fax +49 74 43/12-45 91  
info@fischertechnik.de  
www.fischertechnik.de

**fischertechnik** 

