

fischertechnik 



fischertechnik GmbH  
Klaus-Fischer-Str. 1  
72178 Waldachtal  
Germany

Phone: +4974 43/12-43 69  
Fax: +4974 43/12-45 91

info@fischertechnik.de  
www.fischertechnik.de

# JUNIOR Constructor

www.fischertechnik.de

190837 · 03/22 · Co · Printed in Germany · Technische Änderungen vorbehalten · Subject to technical modifications

fischertechnik 



# JUNIOR Constructor



Bauanleitung  
Assembly instruction  
Instructions de montage  
Bouwhandleiding  
Instrucciones de construcción  
Manual de montagem

Istruzioni di montaggio  
Инструкция по сборке  
安装说明书

MODELS

8



3

---



7

---



13

---



21

---



30













37



44



49

	31 011 1 x		37 238 3 x		78 728 1 x		144 446 1 x
	32 064 3 x		37 468 2 x		122 649 1 x		172 804 6 x
	35 053 2 x		38 225 1 x		127 471 2 x		172 805 6 x
	35 073 2 x		38 253 1 x		127 472 3 x		191 509 1 x
	36 576 1 x		38 411 2 x		130 593 2 x		
	36 586 4 x		38 423 10 x		142 251 4 x		
	37 237 1 x		38 486 4 x		142 252 4 x		

- Alle Einzelteile, insbesondere bewegliche Teile sind falls notwendig zu warten und zu reinigen.
- All components, especially moving parts, should be maintained and cleaned as necessary.
- Toutes les pièces détachées et en particulier les pièces mobiles, sont, si nécessaire, à entretenir et à nettoyer.
- Alle onderdelen, vooral de bewegende delen, kunnen, indien noodzakelijk, onderhouden en gereinigd worden.
- Es necesario mantener limpio y en buen estado cada una de las piezas. Particularmente las piezas móviles.

- Todas as peças individuais, especialmente peças móveis, devem ser submetidas à manutenção e limpas se necessário.”
- Se necessario, tutti i singoli componenti, soprattutto le parti mobili, si devono eventualmente sottoporre a manutenzione e pulizia.
- Все детали, особенно подвижные, требуют ухода и чистки.
- 必要时应保养和清洁所有零件，尤指运动部件。





**1**

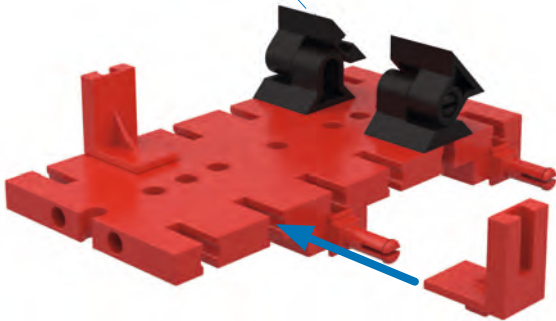
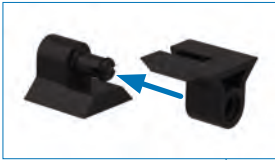
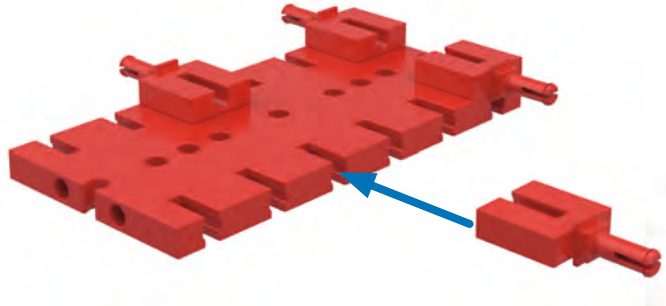

**2**



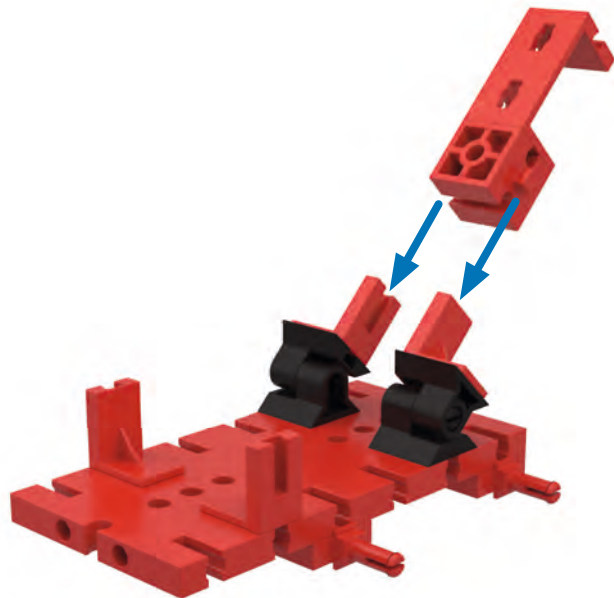

**3**

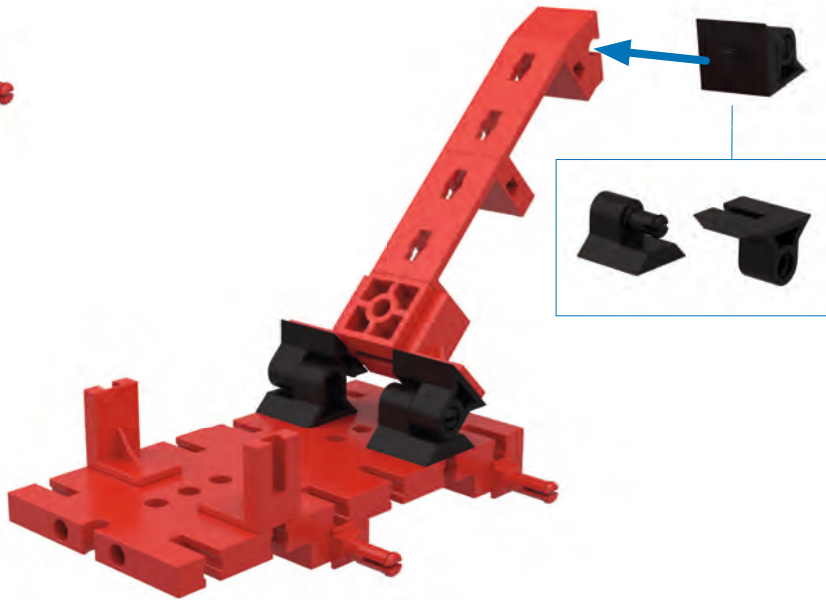
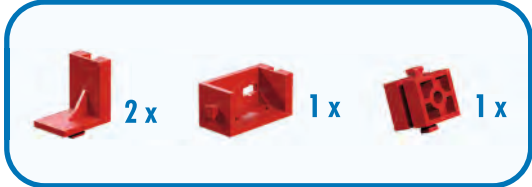

**4**



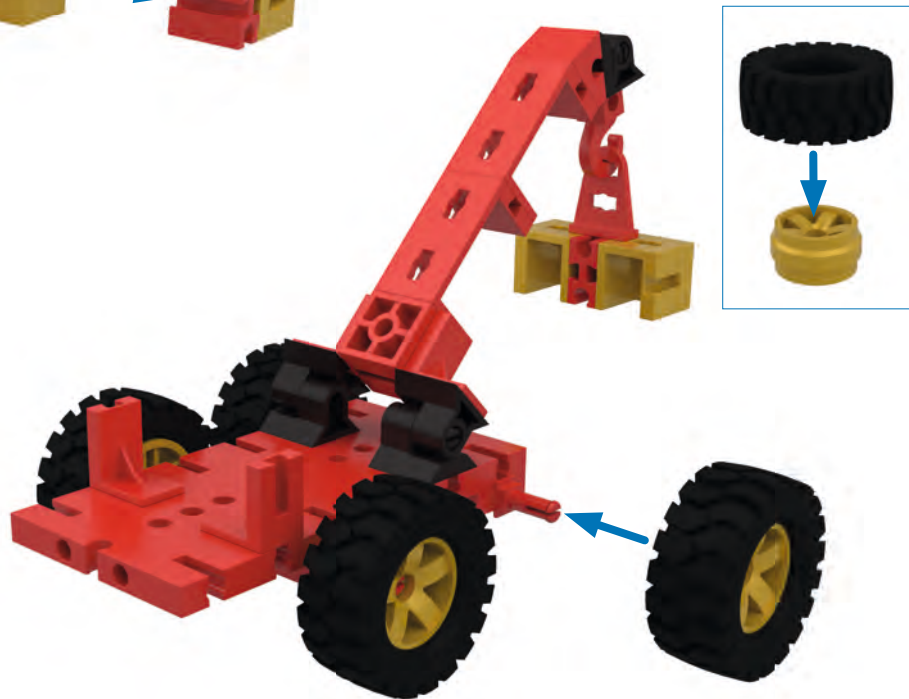
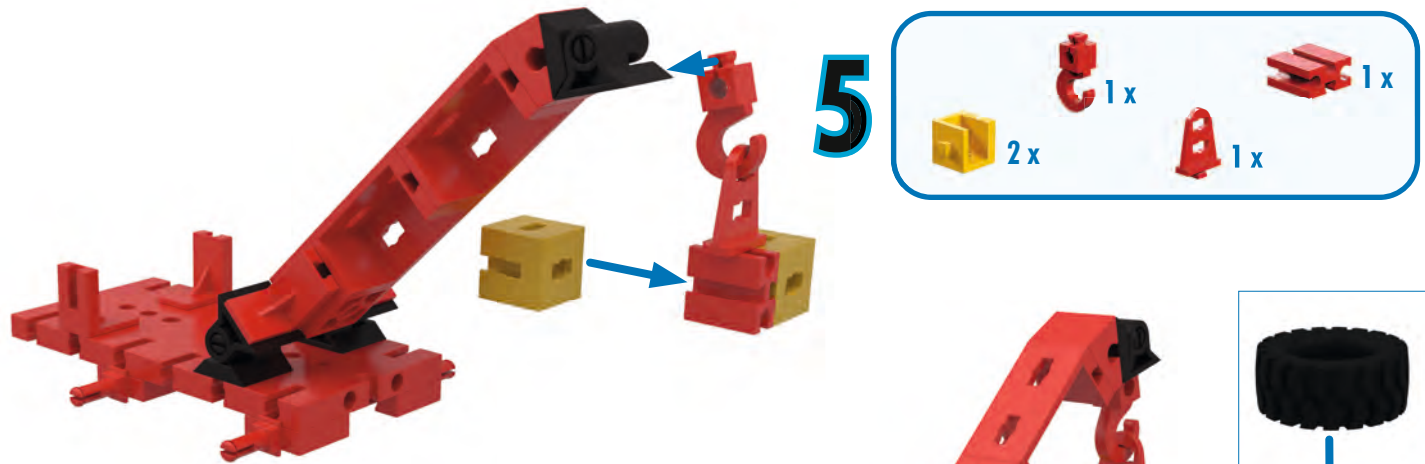



7







**1**

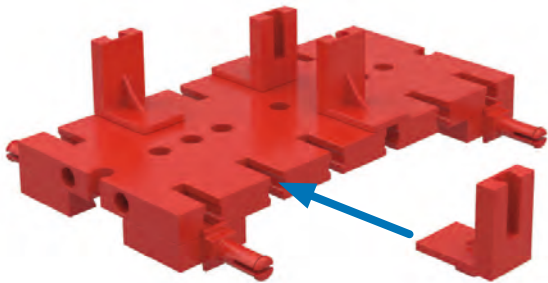
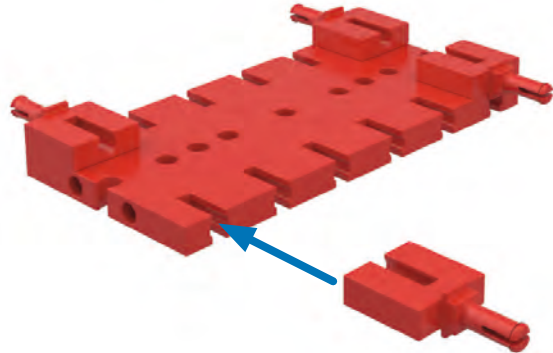

**2**

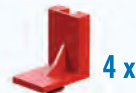

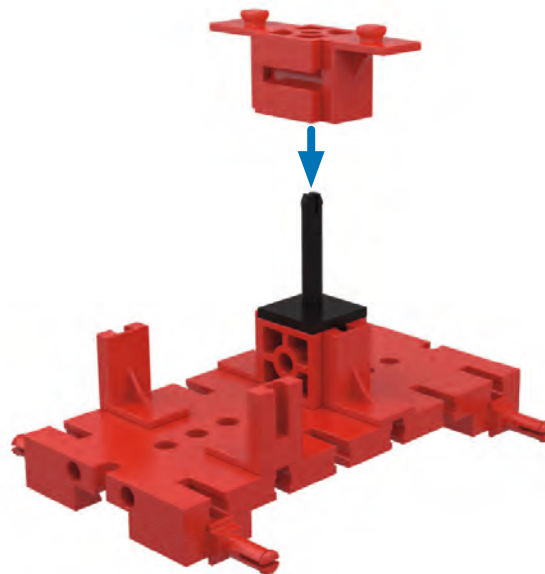
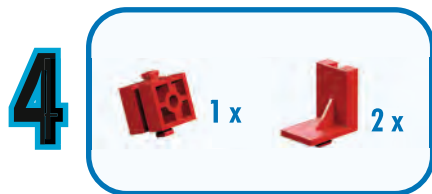
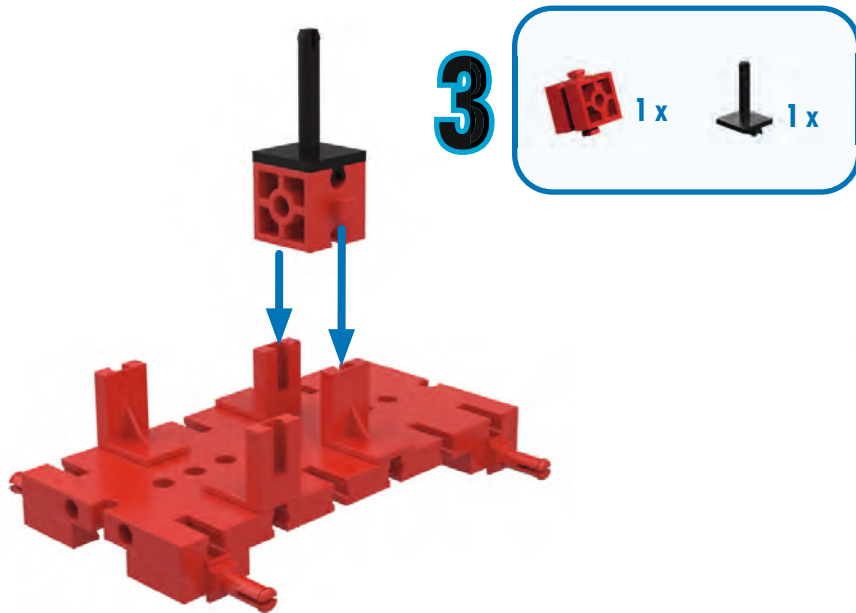



5

2x 2x 1x

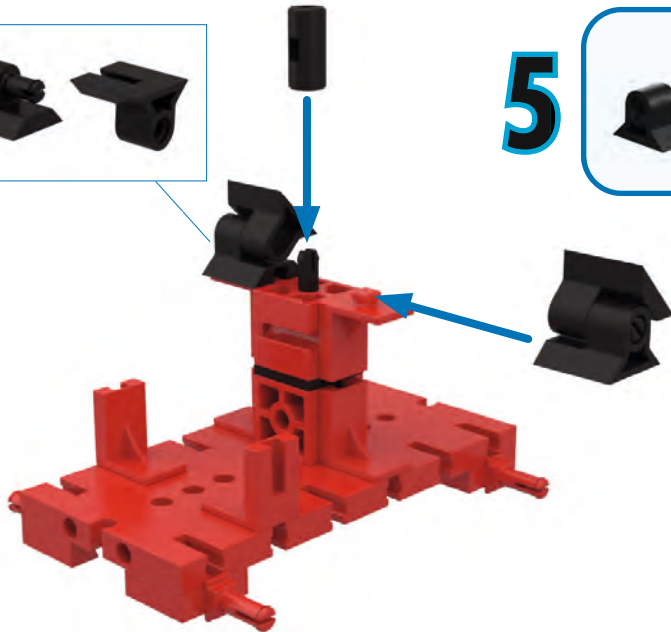

6

2x 1x

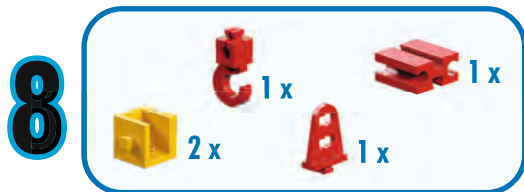
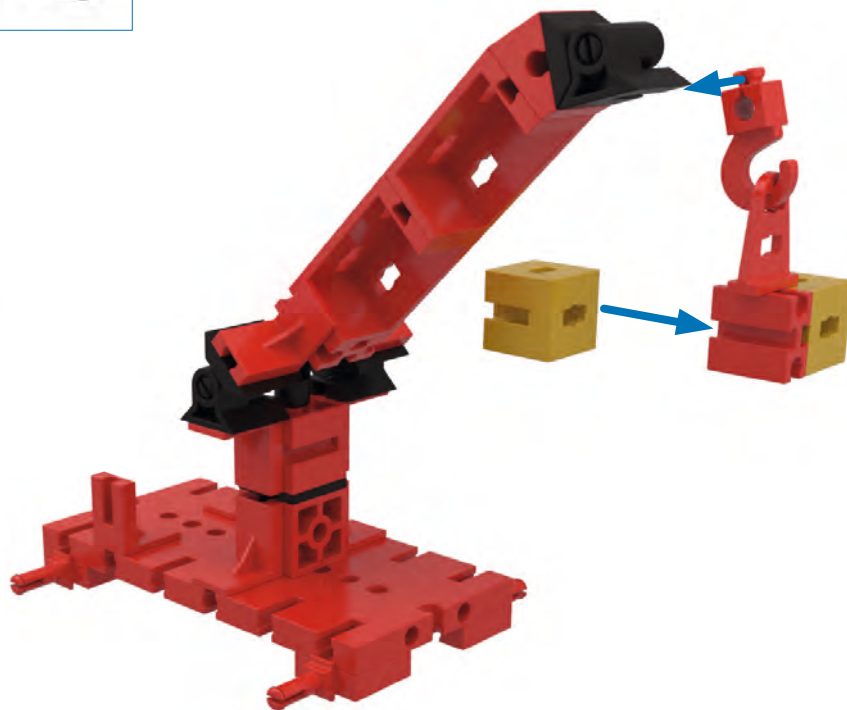
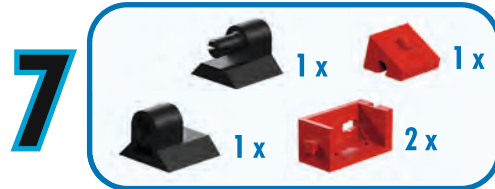
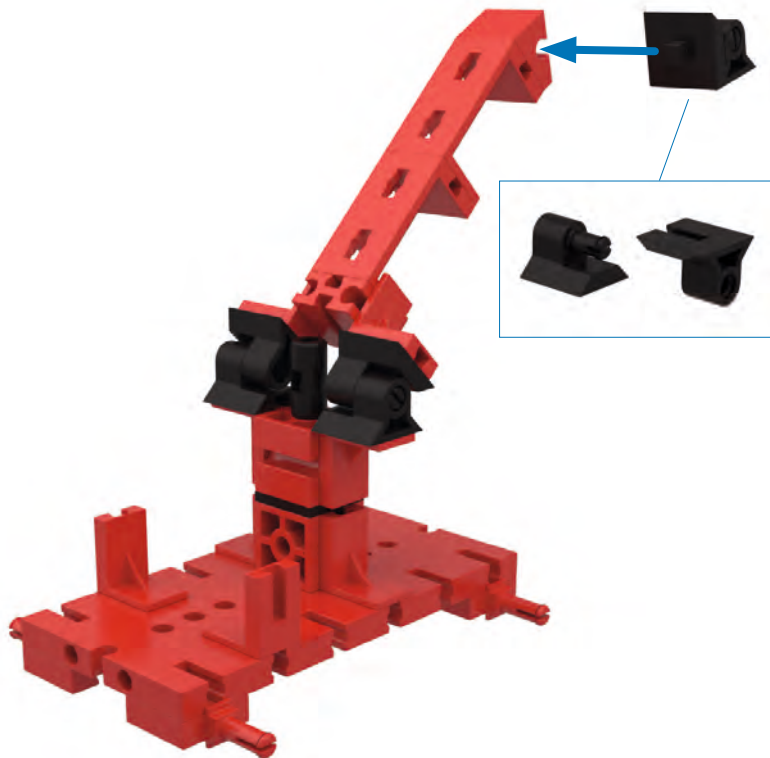

9



4 x



4 x







**10**





**1**

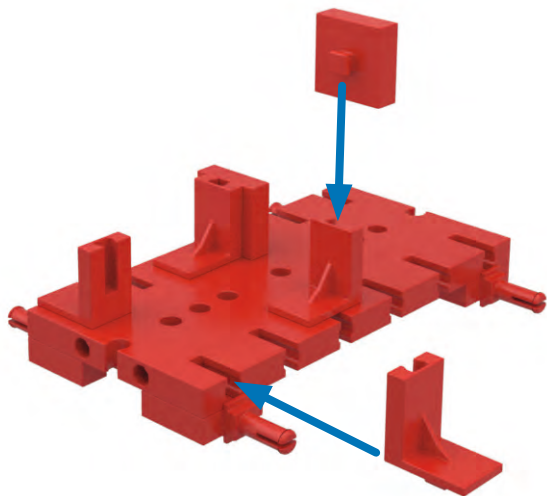
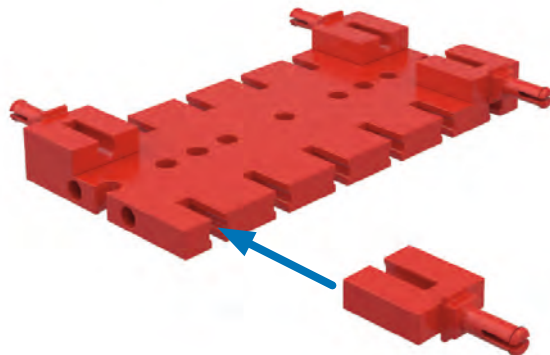

**2**



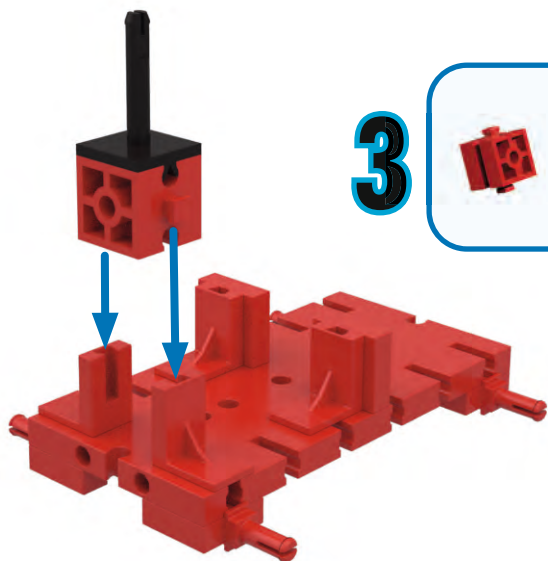

3

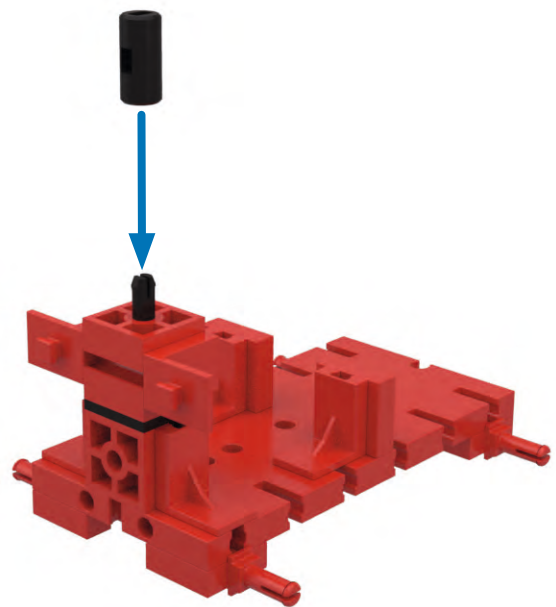

4



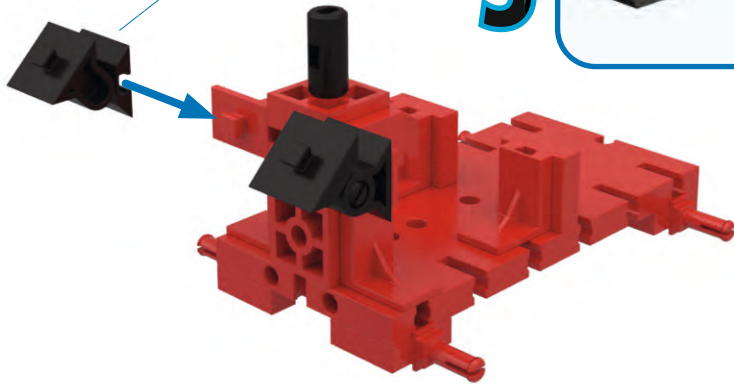

5

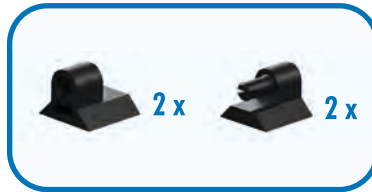

6

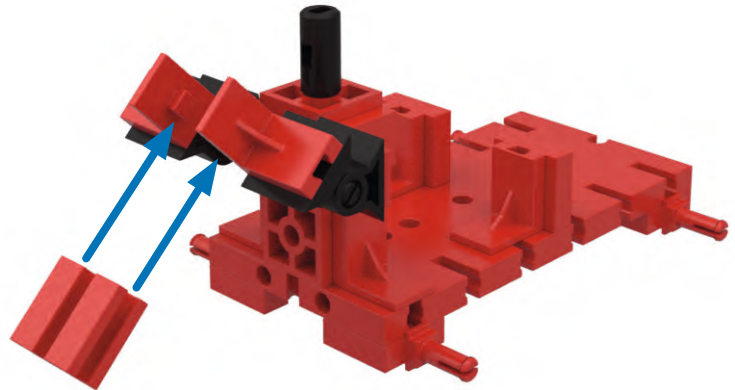
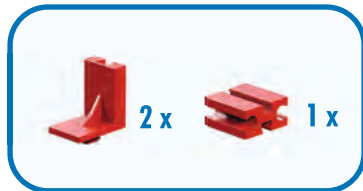

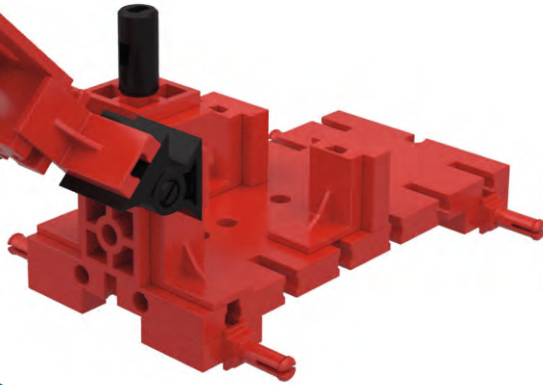

**7**



1x



1x



2x



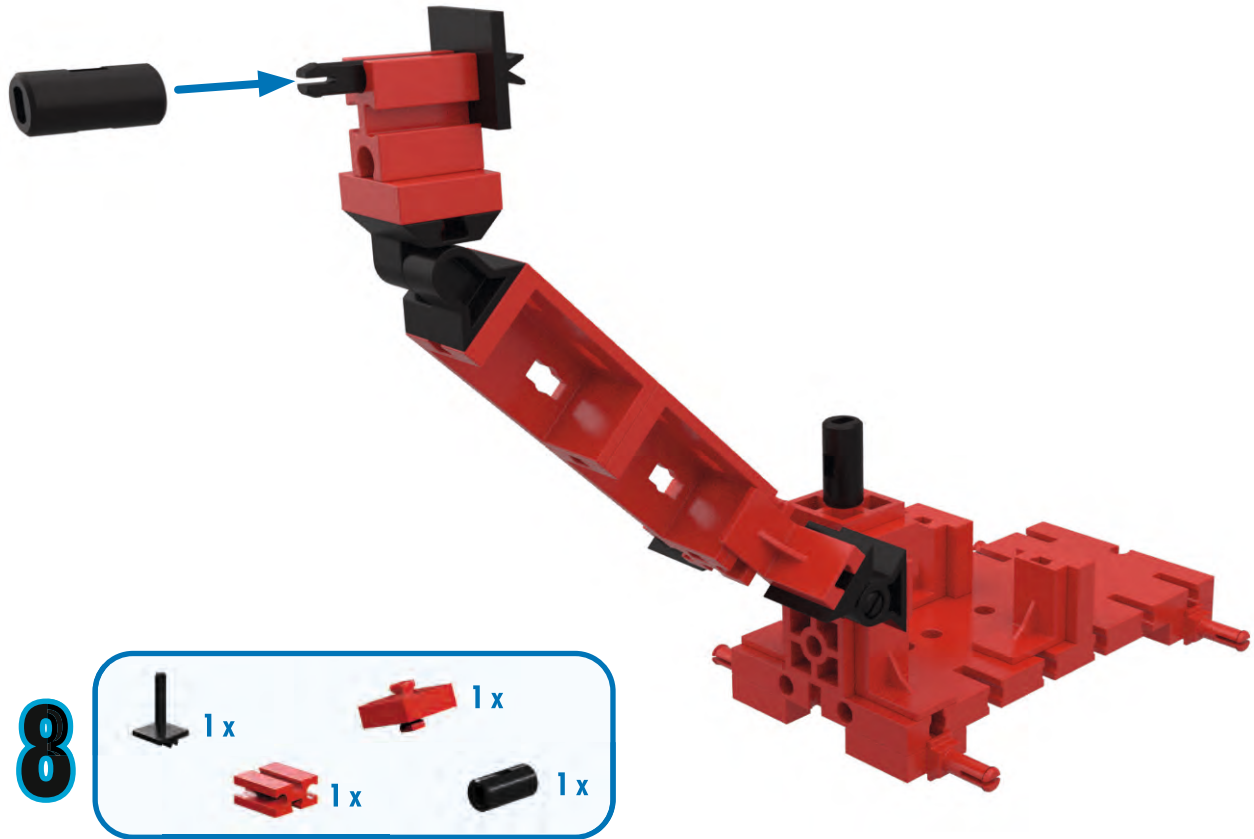

9

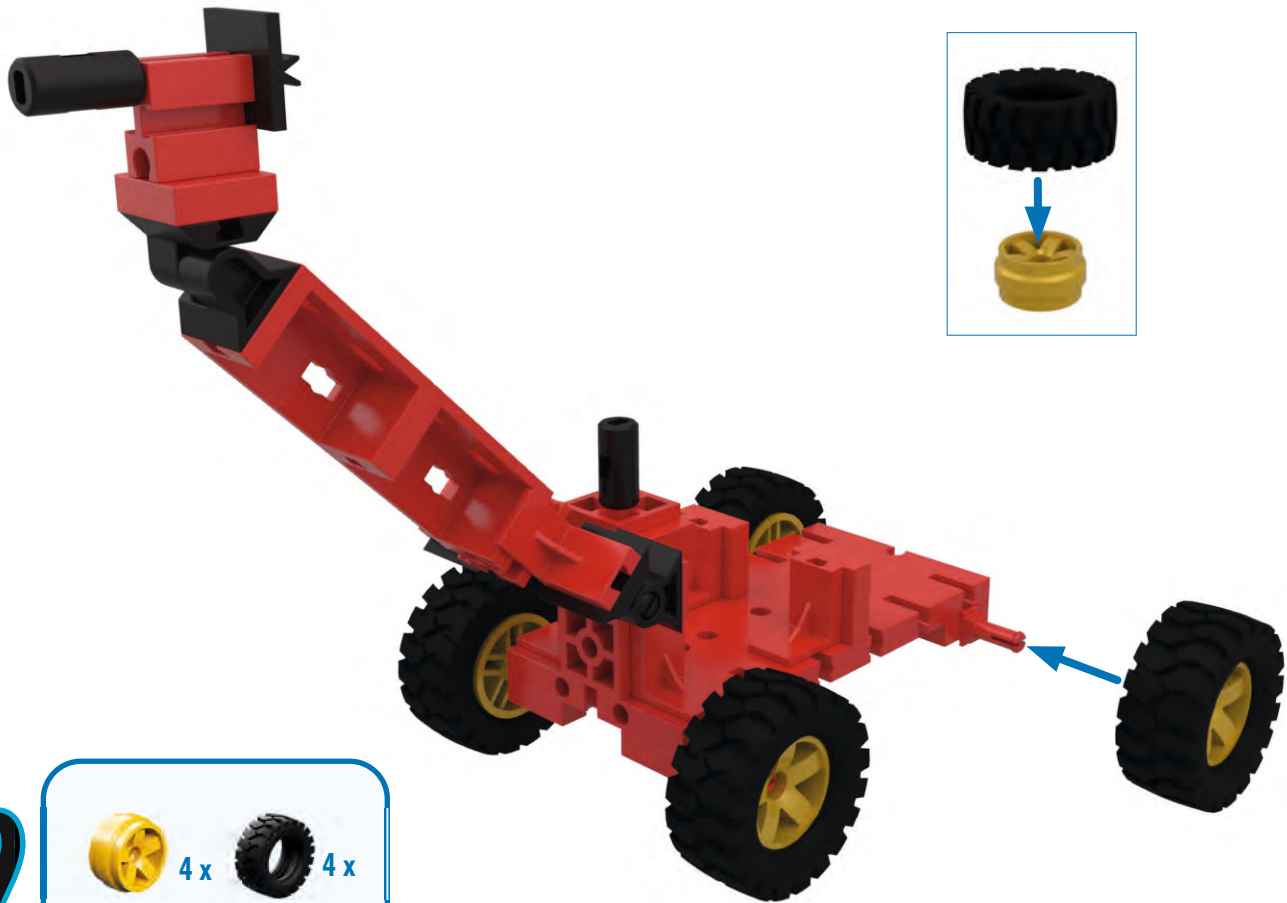

10







**1**

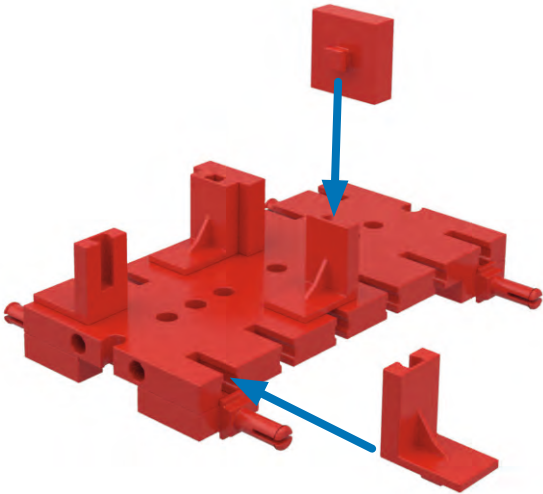
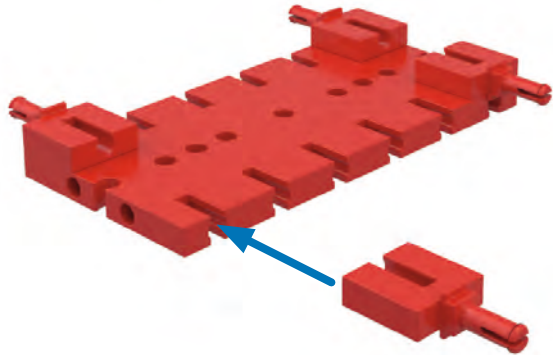
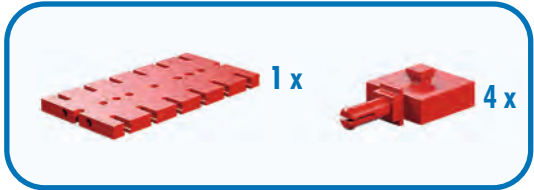

**2**

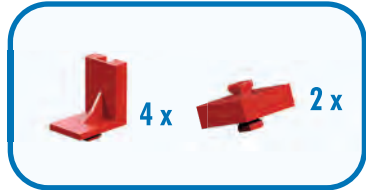



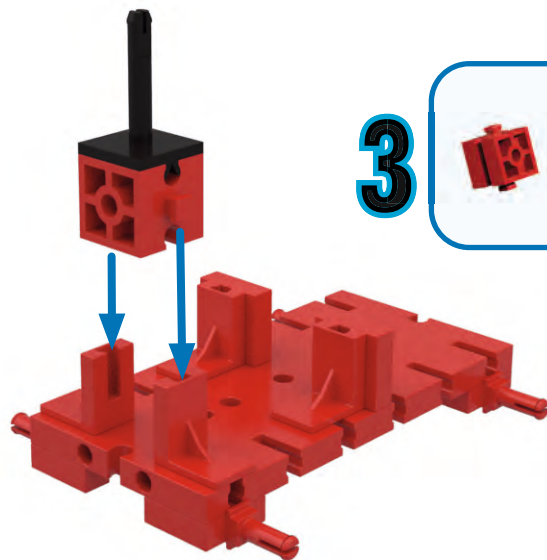

3



1x



1x

4



1x



2x



1x

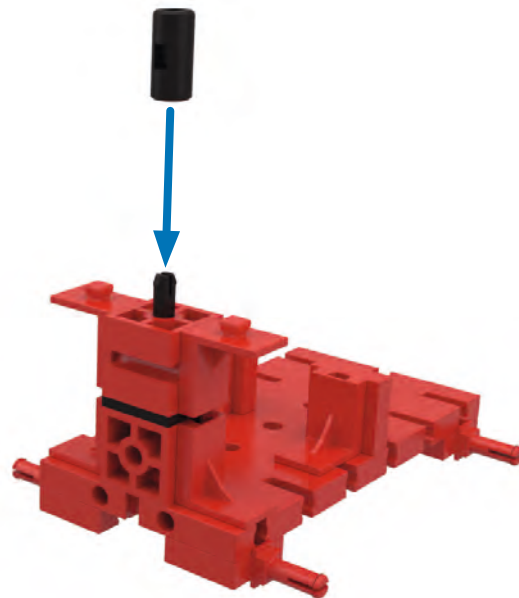



5

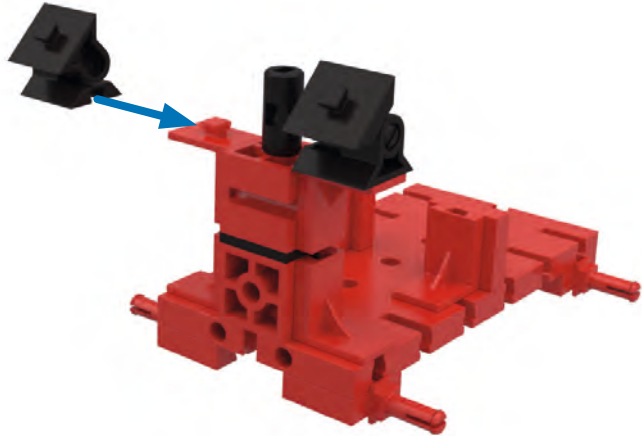
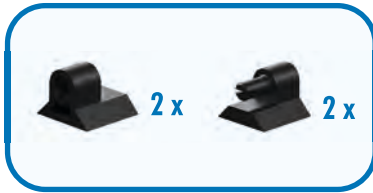

6

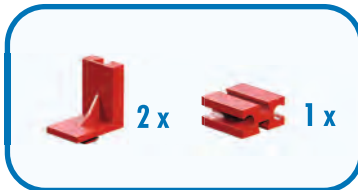

7

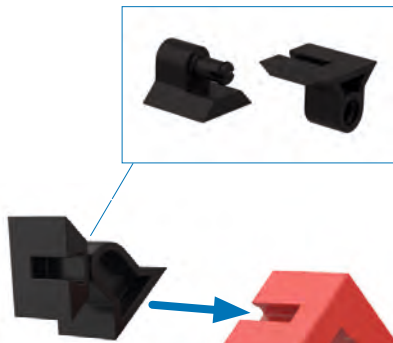

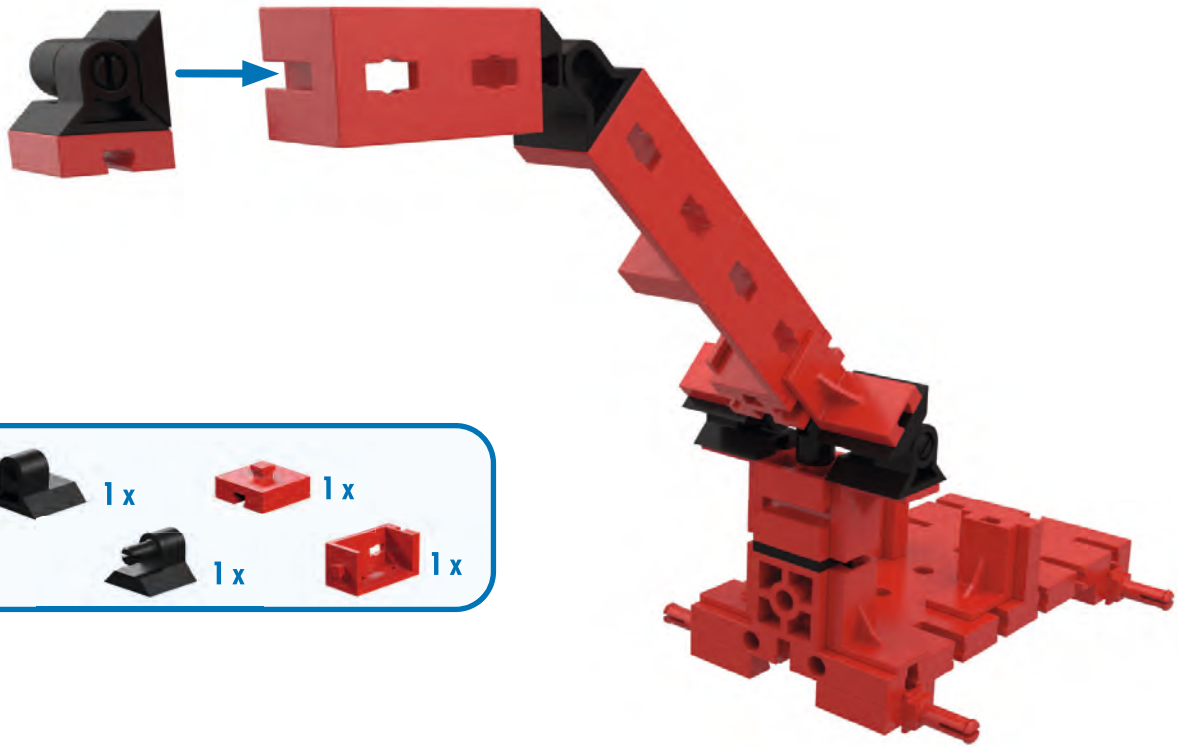

8



1x



1x



1x



1x

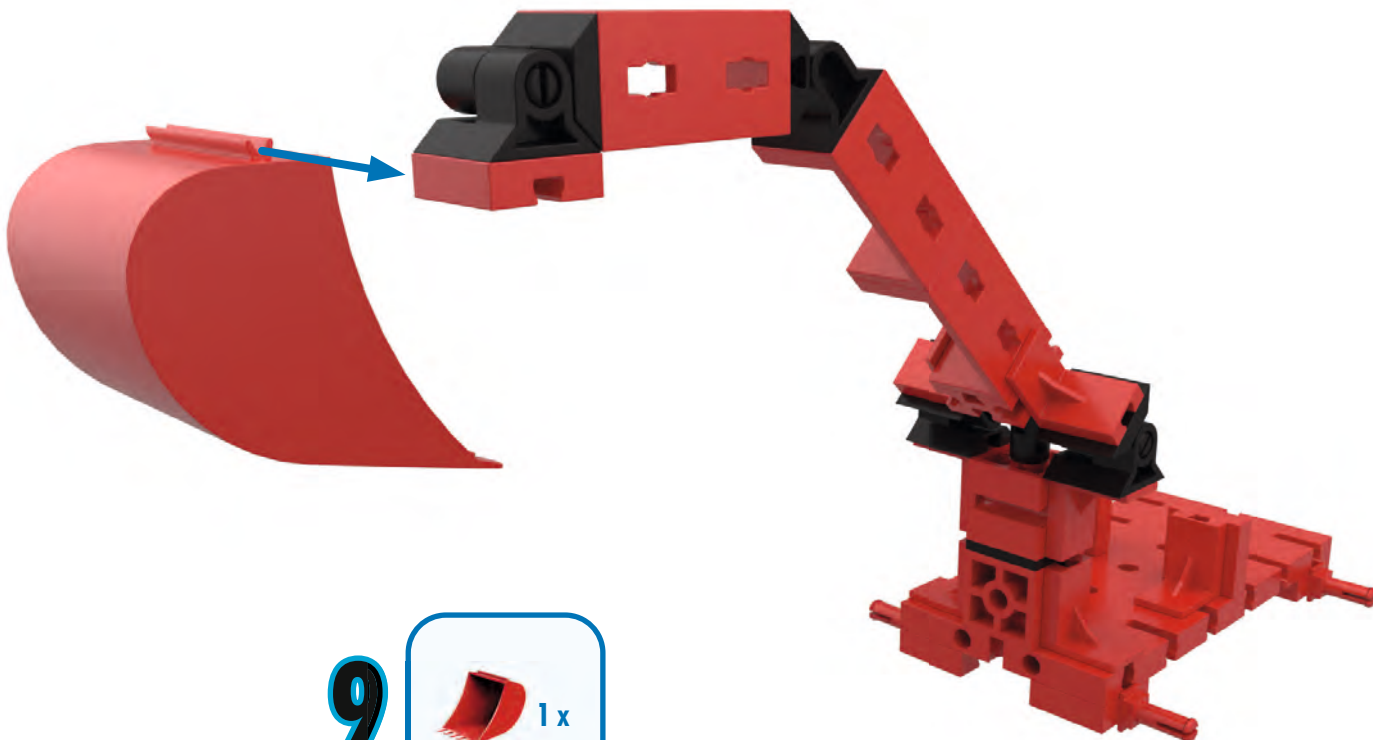

**9**  1x





**10**



4 x



4 x

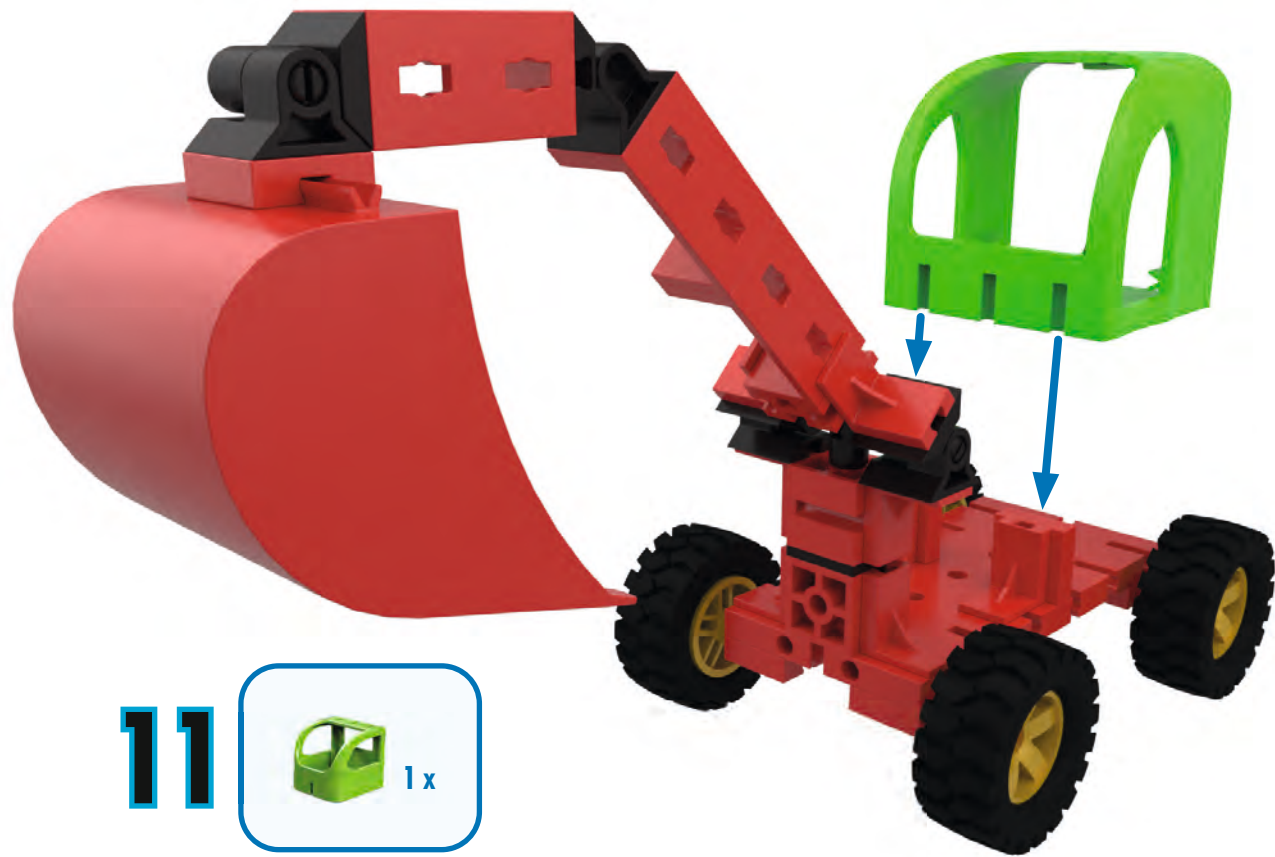

**11**







**1**

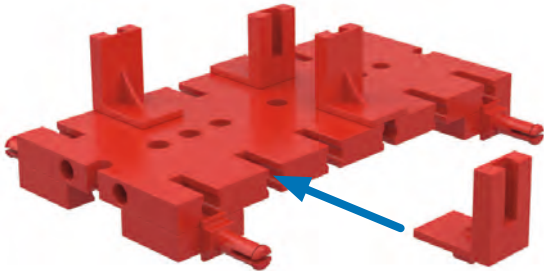
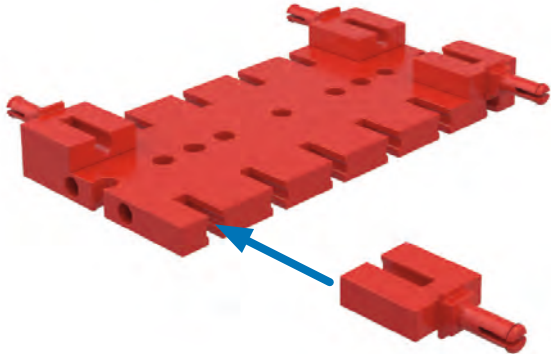
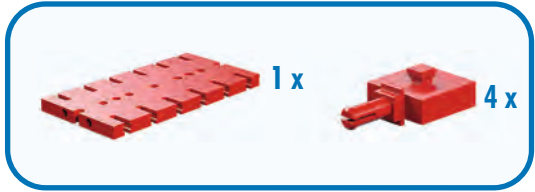

**2**



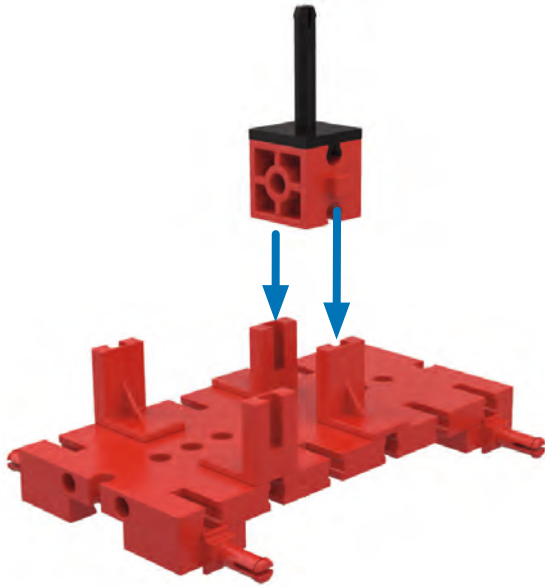

3



1x



1x

4



1x



2x



1x

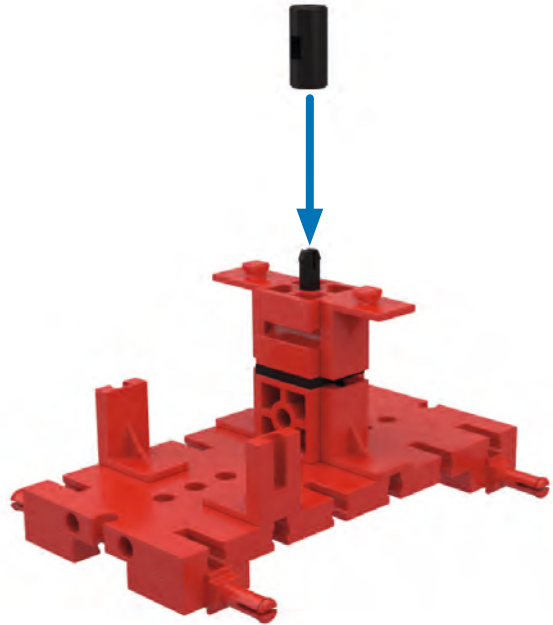

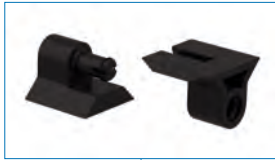
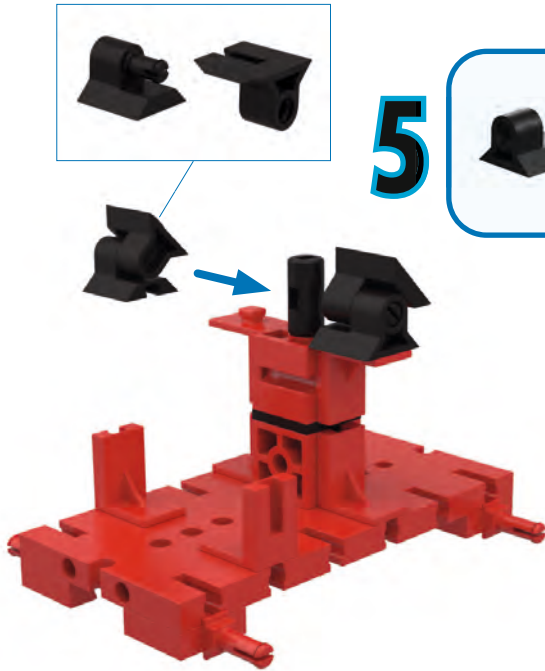

5

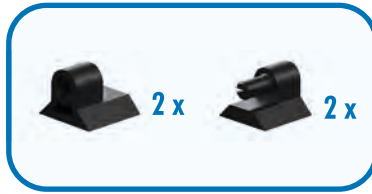

6

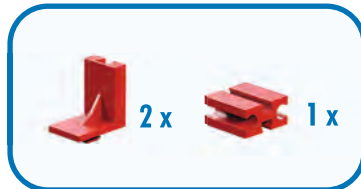



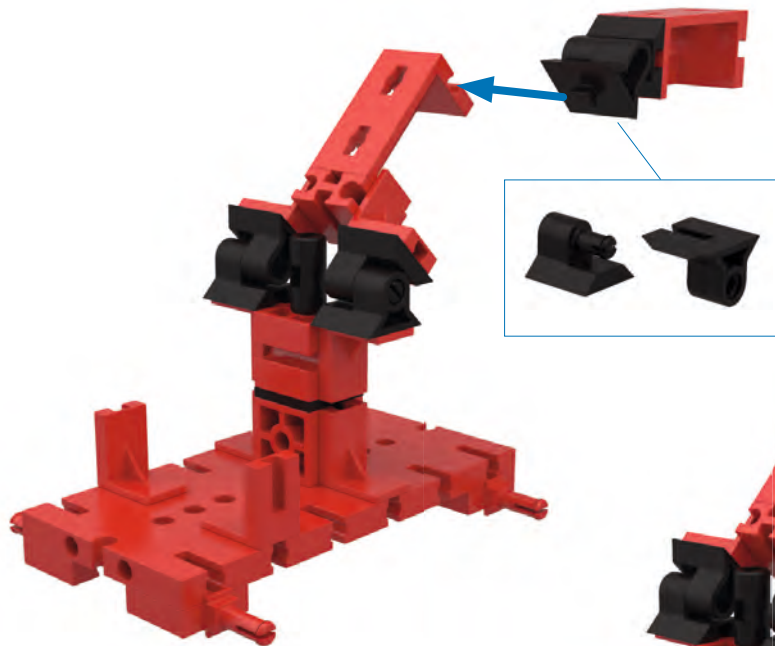

7

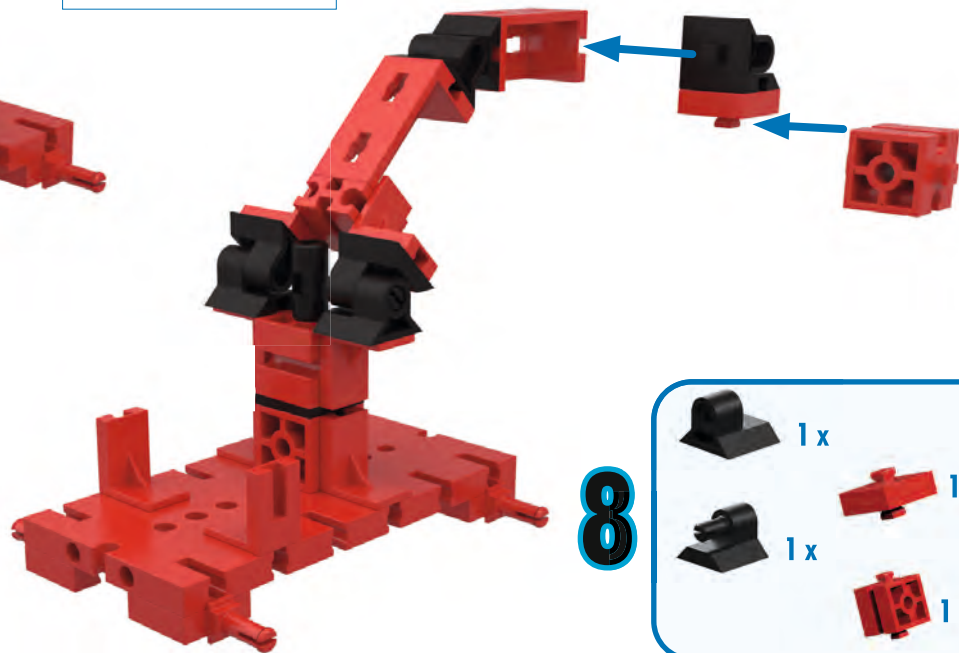

8

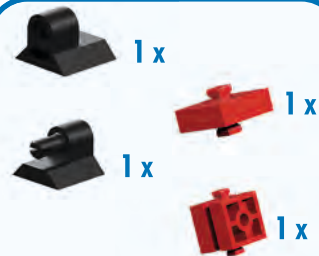

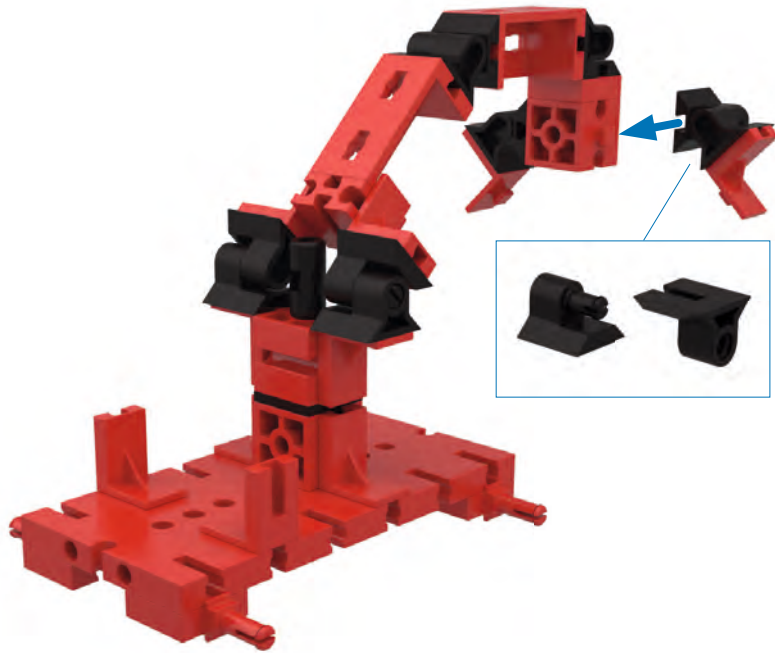

9



10

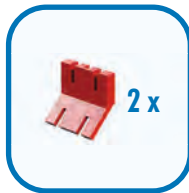

# 11

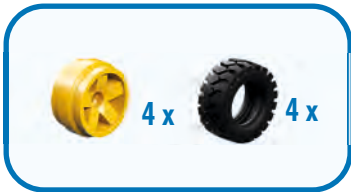

12





1

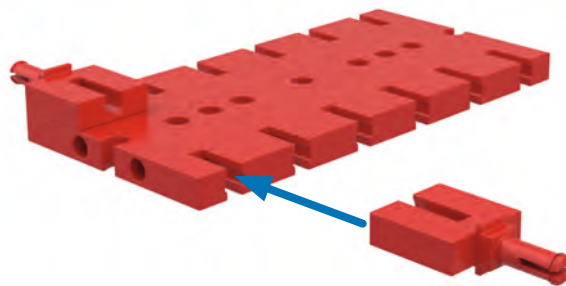

2

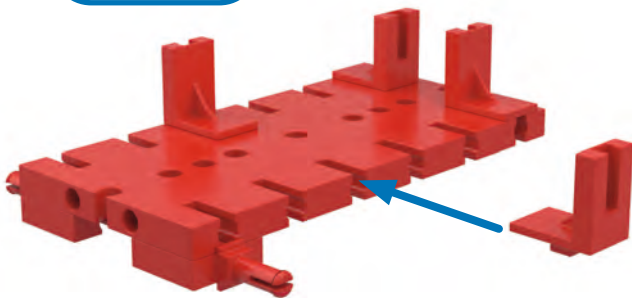

3

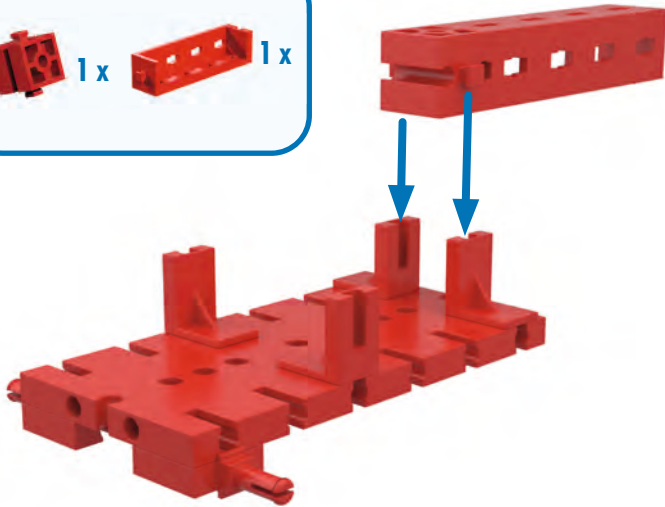
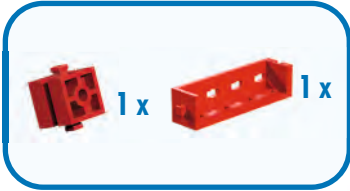

4

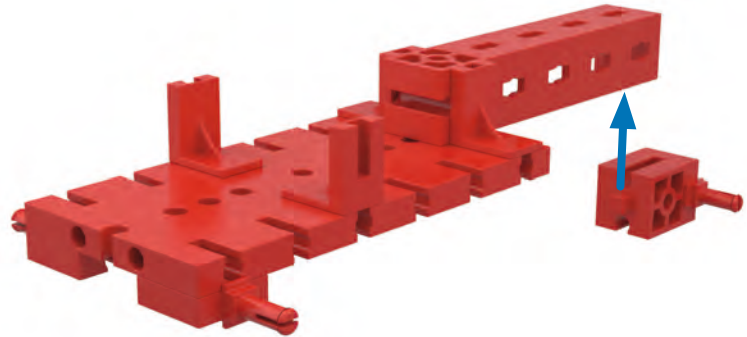
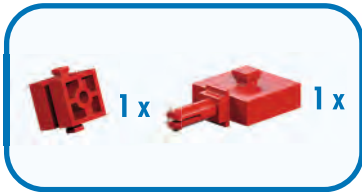



5

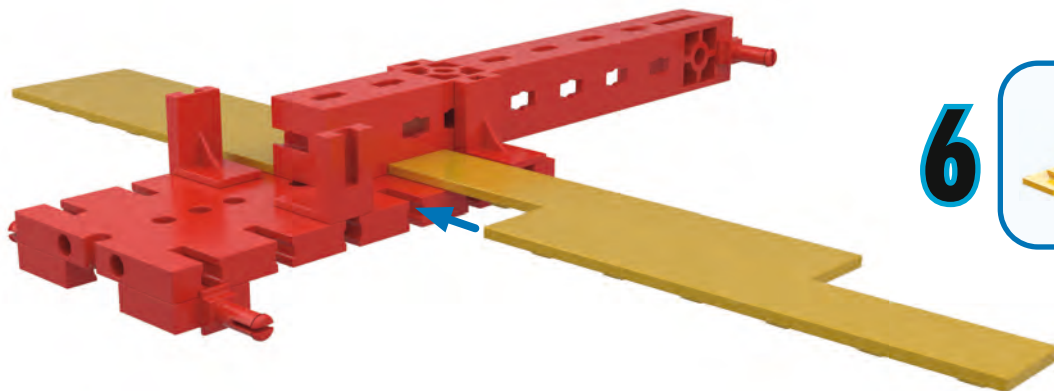
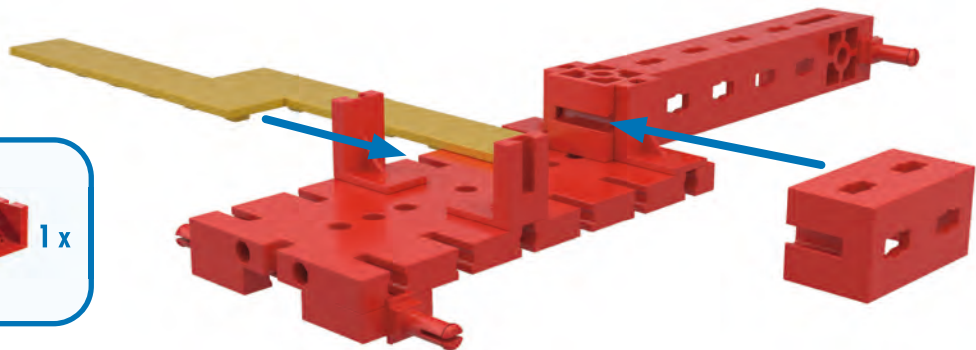
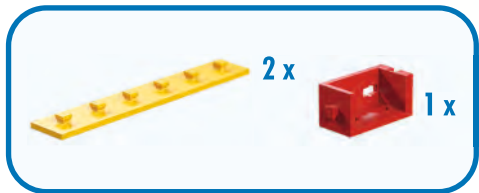

6





7



8





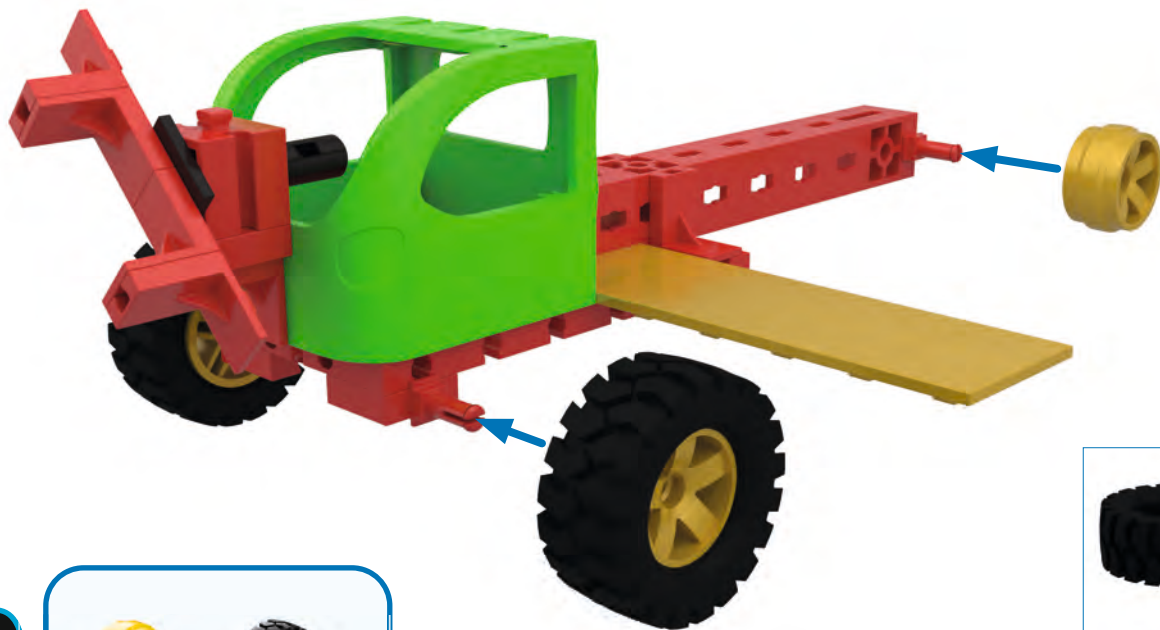

10

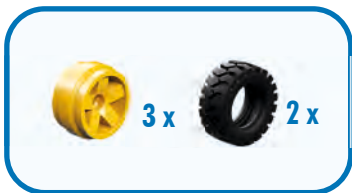





**1**

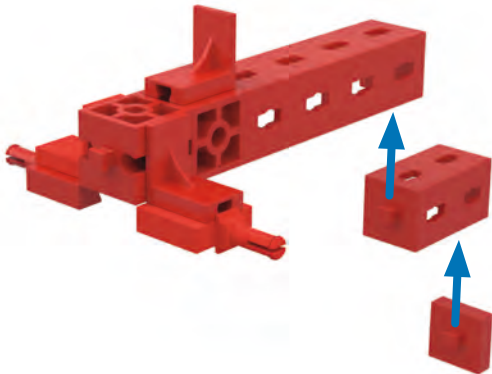
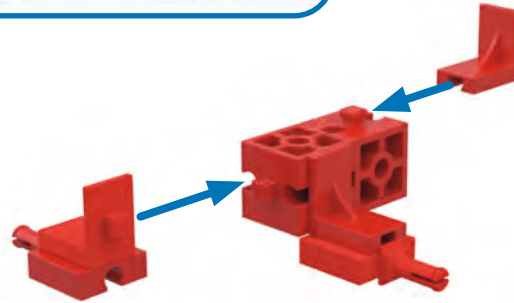
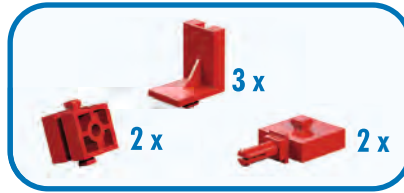

**2**

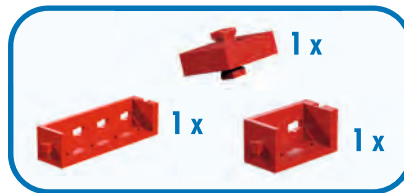



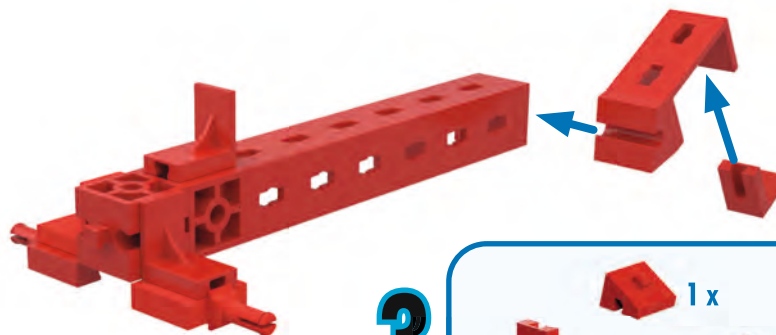

**3**

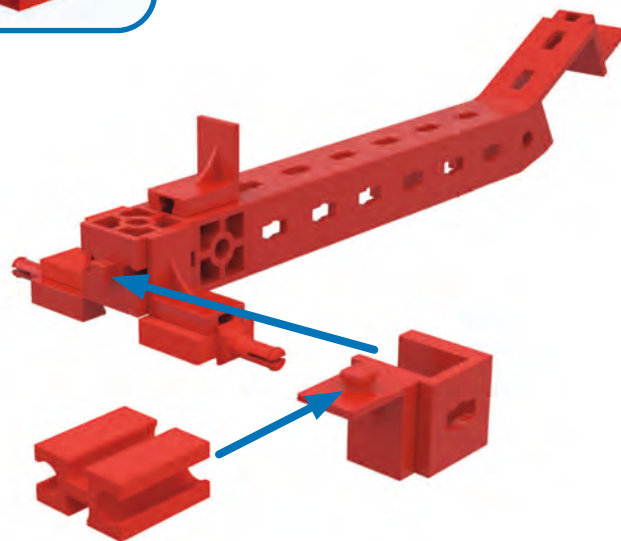
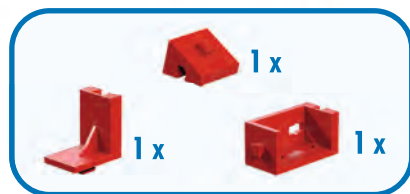

**4**

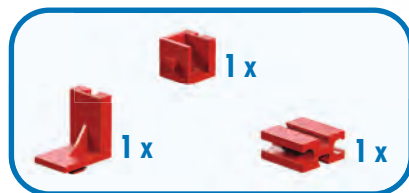

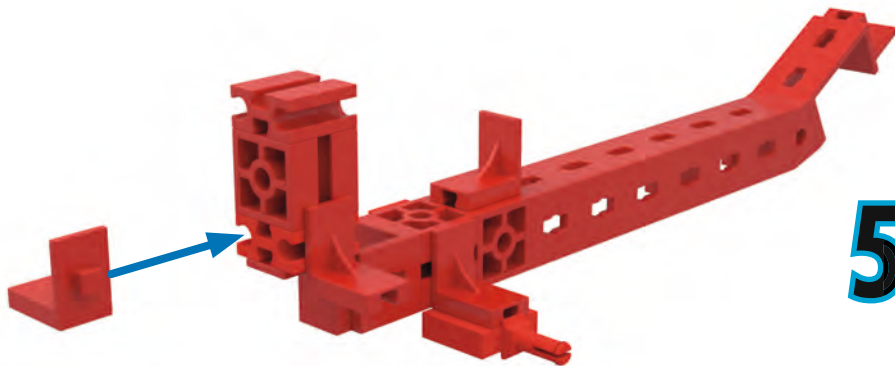

5

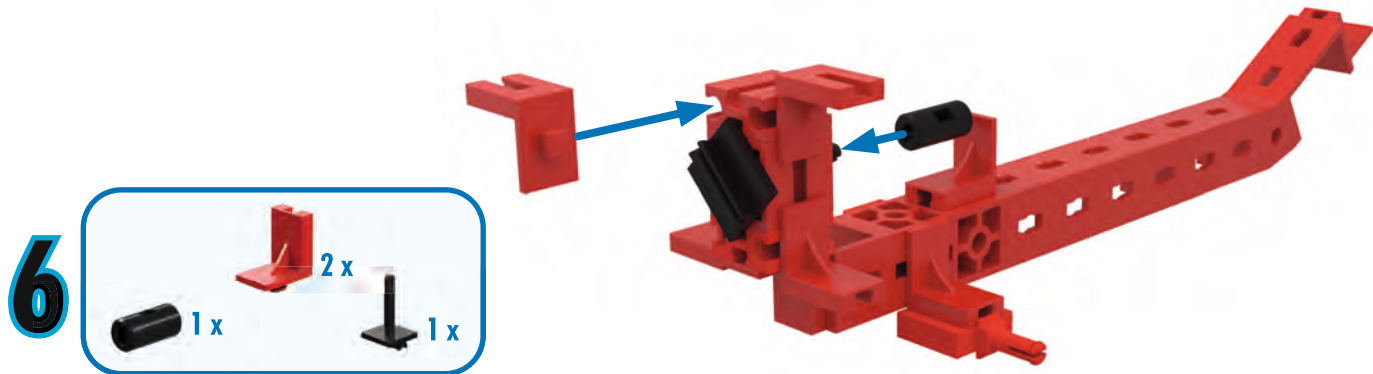
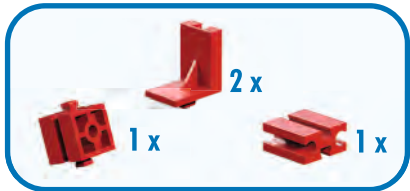

6



7



8

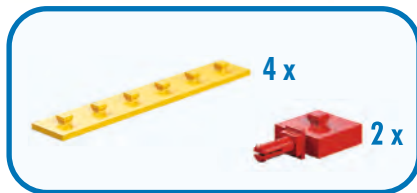





**1**

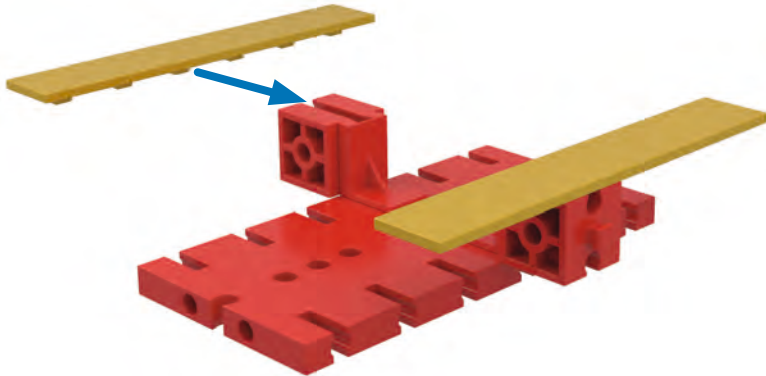
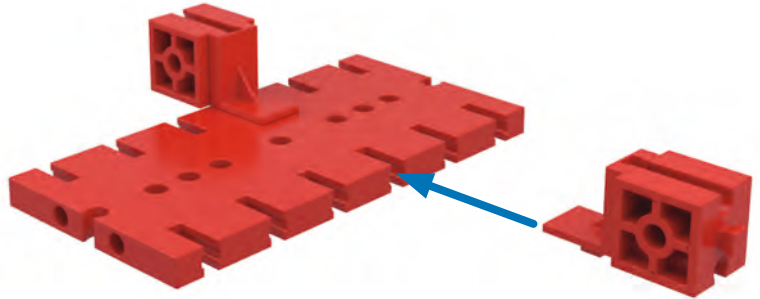
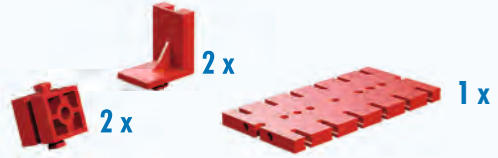

**2**



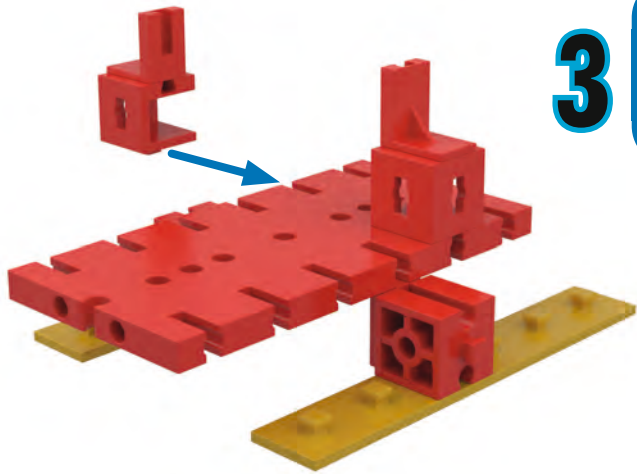

3

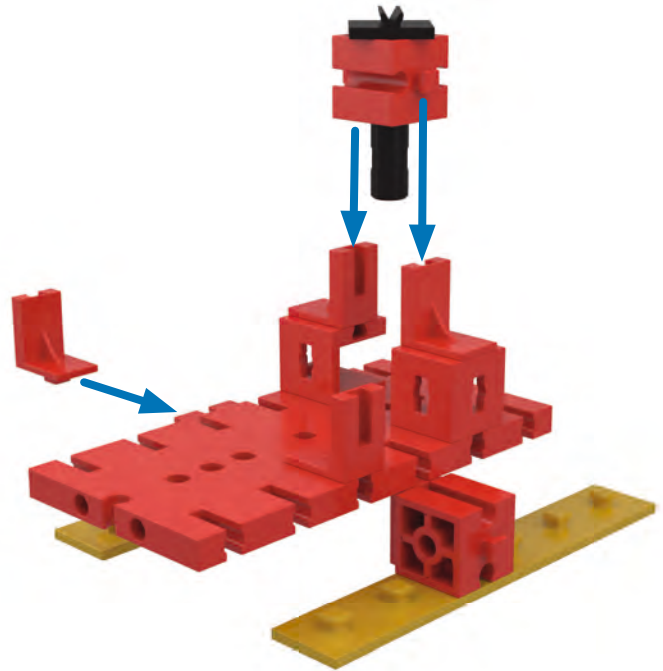
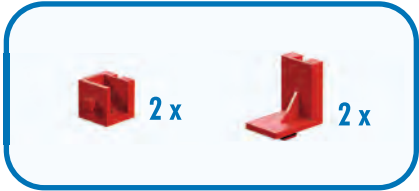

4



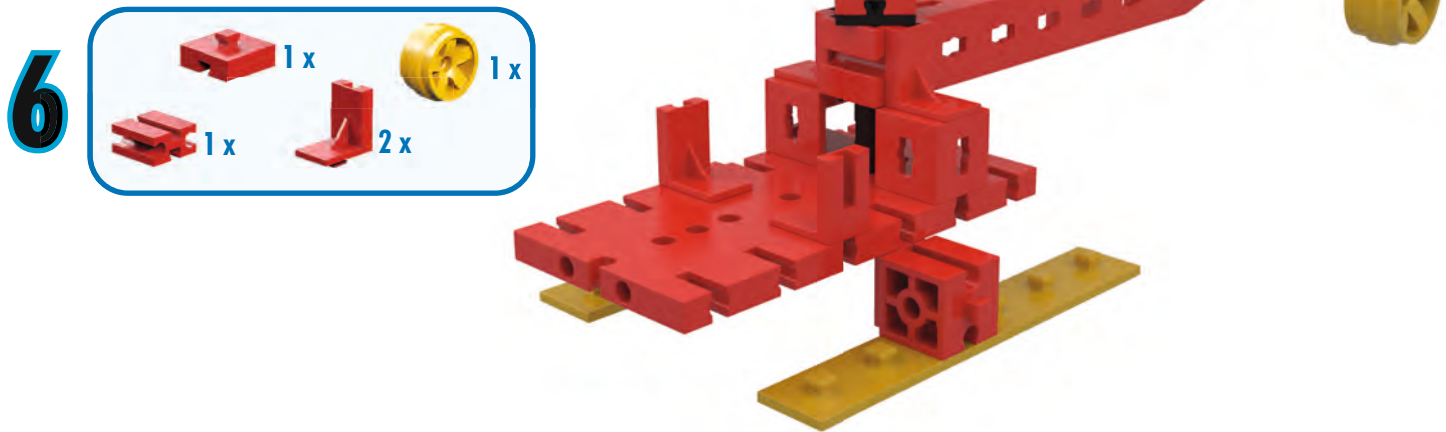
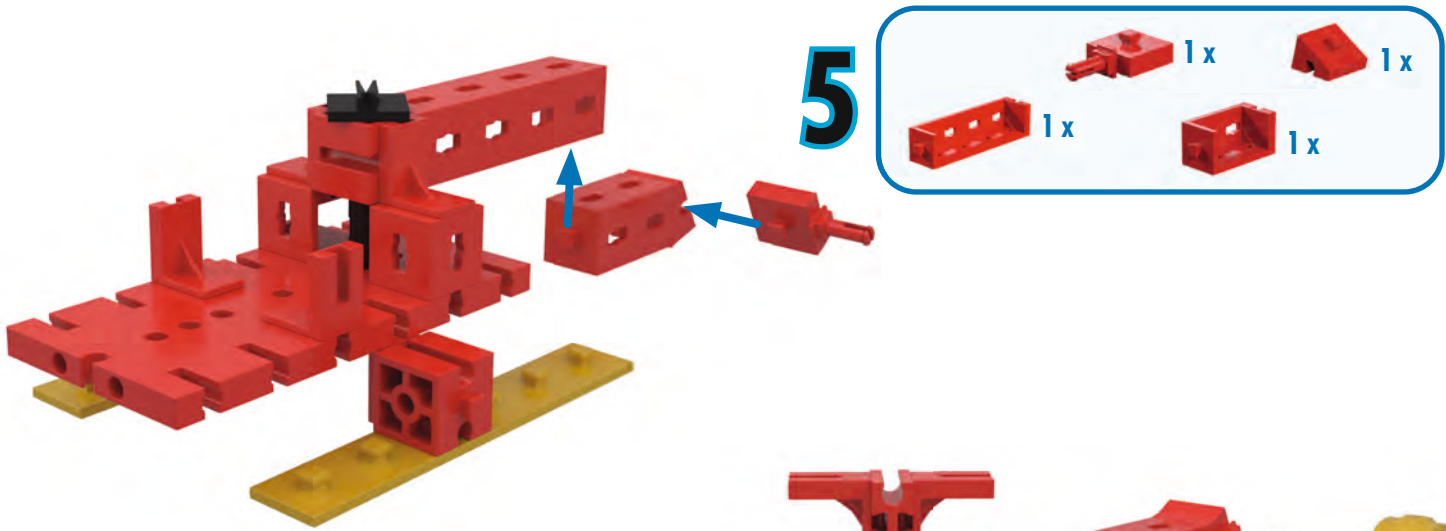



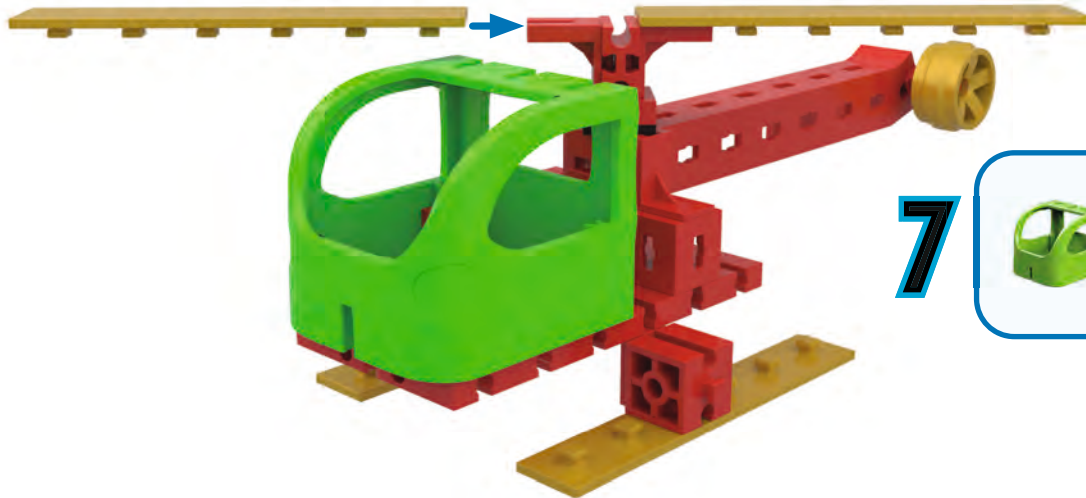

7

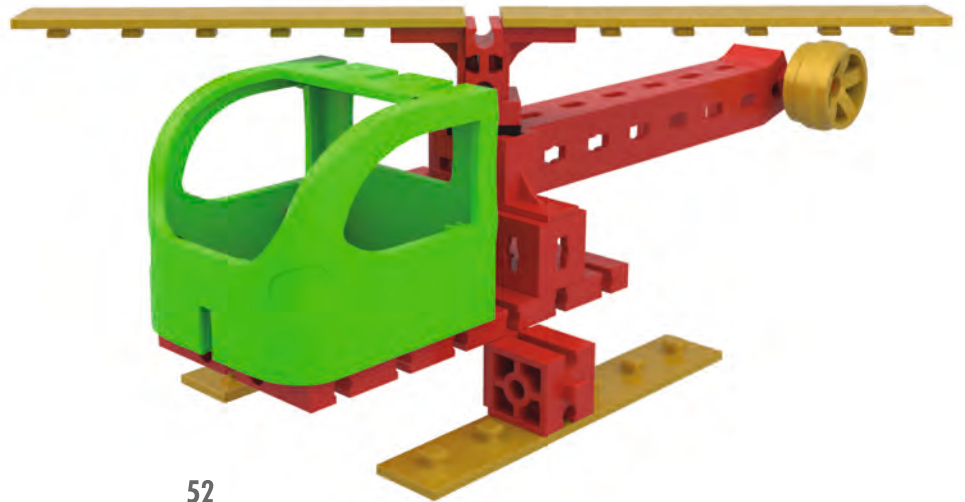
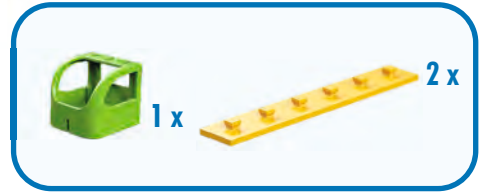



- Werde Mitglied im kostenlosen fischertechnik Fan Club und nutze die Vorteile. Melde dich hierzu einfach unter **[www.fischertechnik.de/FanClub](http://www.fischertechnik.de/FanClub)** an.
- Become a member of the free fischertechnik fan club and take advantage of the benefits. Simply register at **[www.fischertechnik.de/FanClub](http://www.fischertechnik.de/FanClub)**
- Deviens membre du Fan club fischertechnik gratuit et profite de nombreux avantages. Il suffit de t'inscrire sur **[www.fischertechnik.de/FanClub](http://www.fischertechnik.de/FanClub)**.
- Word lid van de gratis fischertechnik Fan Club en maak gebruik van de voordelen. Meldt u hiervoor aan op **[www.fischertechnik.de/FanClub](http://www.fischertechnik.de/FanClub)**.
- Hazte miembro del club de aficionados gratuito de fischertechnik y disfruta de todas las ventajas. Regístrate en **[www.fischertechnik.de/FanClub](http://www.fischertechnik.de/FanClub)**.
- Torne-se um membro do fã-club gratuito da Fischertechnike aproveite-a. Basta registrar-se em **[www.fischertechnik.de/FanClub](http://www.fischertechnik.de/FanClub)**.
- Diventa membro del fan club gratuito di fischertechnik e sfrutta tutti i vantaggi. Basta registrarsi a **[www.fischertechnik.de/FanClub](http://www.fischertechnik.de/FanClub)**.
- Стань членом бесплатного фан-клуба fischertechnik и пользуйся преимуществами. Для этого просто зарегистрируйся по адресу **[www.fischertechnik.de/FanClub](http://www.fischertechnik.de/FanClub)**.
- 免费加入慧鱼粉丝俱乐部 (fischertechnik Fan Club) 会员，即刻享受会员福利。只需前往 **[www.fischertechnik.de/FanClub](http://www.fischertechnik.de/FanClub)** 完成注册即可。