

EINZELTEILÜBERSICHT
SPARE PARTS LIST
LISTE DES PIÈCES DÉTACHÉE

ONDERDELENOVERZICHT
LISTA DE PIEZAS
LISTA DEI PEZZI

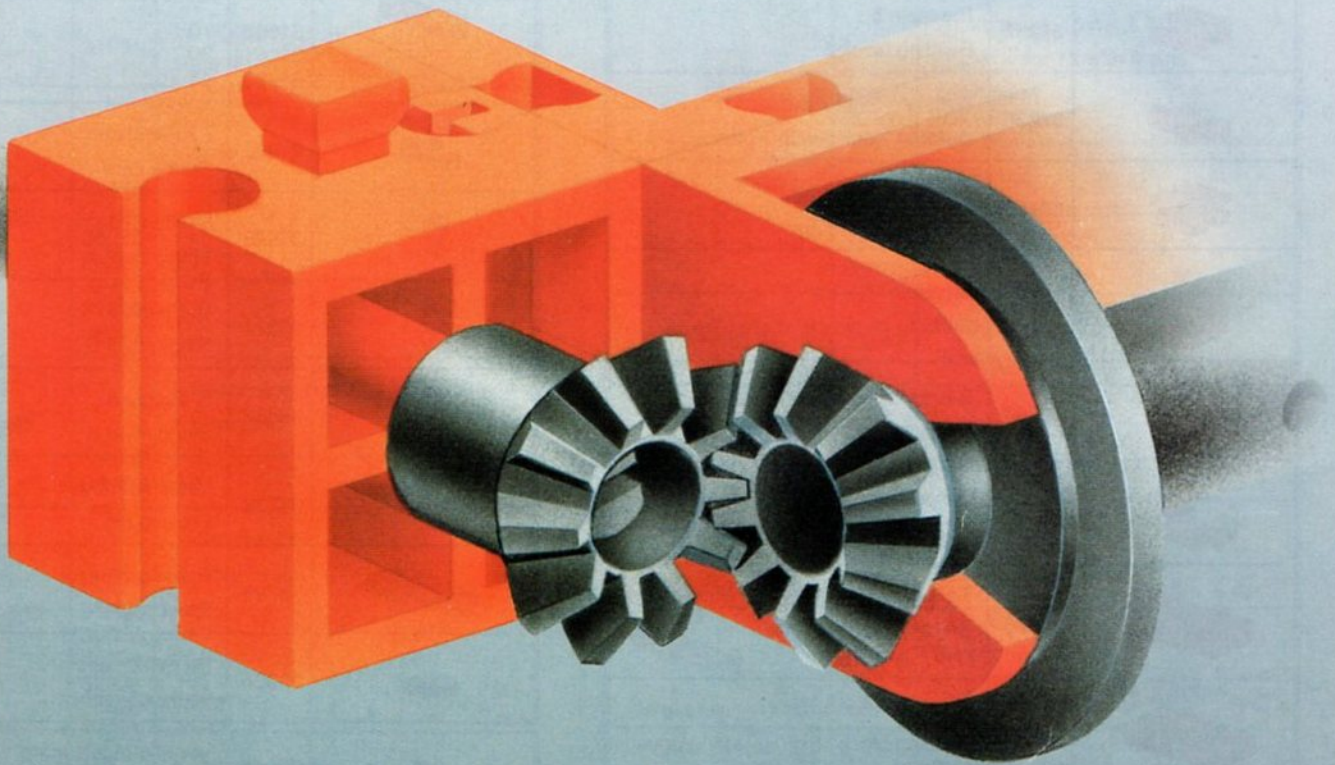

fischertechnik[®] [®]















Einzelteile Spare parts Pièces détachées

	32879	Baustein 30 Building block 30
	32880	Baustein 30 mit Bohrung Building block 30 with bore
	32881	Baustein 15 Building block 15
	32882	Baustein 15 mit 2 Zapfen Building block 15 with 2 pins
	31010	Winkelstein 60° Angular block 60°
	31011	Winkelstein 30° Angular block 30°
	31981	Winkelstein 15° Angular block 15°
	32071	Winkelstein 7,5° Angular block 7,5°
	37237	Baustein 5 Building block 5
	37238	Baustein 5 mit 2 Zapfen Building block 5 with 2 pins
	37468	Baustein 7,5 Building block 7,5
	38240	Baustein V15 Eck Building block V15 corner
	32064	Baustein 15 mit Bohrung Building block 15 with bore
	38423	Winkelstein 10x15x15 Angular block 10x15x15
	38428	Bauplatte 15x30x5 mit 3 Nuten Building plate 15x30x5 with 3 grooves
	35049	Baustein 15x30x5 mit Nut und Zapfen Building block 15x30x5 with groove and pin
	38277	Bauplatte 15x45 mit 2x2 Zapfen Building plate 15x45 with 2x2 pins
	31918	Winkelstein 60° mit 3 Nuten Angular block 60° with 3 grooves
	32321	Baustein 15 mit Ansenkung Building block 15 with counterbore

Onderdelen Piezas Pezzi













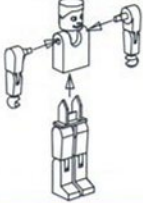

	32330	Bauplatte 15x30x3,75 mit Nut Building plate 15x30x3,75 with groove
	31426	Gelenkwürfel-Zunge Hinged block tab
	31436	Gelenkwürfel-Klaue Hinged block claw
	36819	Lagerhülse Axle sleeve
	36223	Feder-Gelenkstein Spring hinged block
	35019	Gelenkmutter Nut for hinged block
	35018	Gelenkschraube Screw for hinged block
	36050	Gelenksteinfeder Hinged block spring
	31060 31061 31330	Verbindungsstück Link 15 30 45
	31982	Federnocken Spring cam
	36323	S-Riegel 4 Single rivet 4
	36324	S-Riegel 6 Single rivet 6
	36457	S-Riegel 8 Single rivet 8
	37232	Verschlussriegel Locking pin
	35799	Riegelschlüssel Rivet holder
	36334	Riegelscheibe Locking washer
	32316	Verbindungsstopfen Connecting plug
	35975	Statikadapter Statics adapter
	31848	Strebenadapter Strut adapter
	31667	Lasche 15 Connecting strip 15















	31668	Lasche 21,2 Connecting strip 21,2
	31671	L-Lasche L-shaped lug
	31672	T-Lasche T-shaped lug
	31675	Kreuzlasche Cross-shaped lug
	31673	Sternlasche Star-shaped lug
	31674	Adapterlasche Adapter-girth
	31670	Winkellasche Angle-girth
	38253	Kupplungsstück Coupling
	38260	Kupplungsstück 30 Coupling 30
	31994	Schalthebel Gear lever
	38544 31764 36328 36322 32200 31765 36335	I-Strebe gelb I-Strut yellow 15 30 45 60 75 90 120
	36914 36924	I-Strebe schwarz I-Strut black 15 120
	38542 36326 35058 35059 36336	X-Strebe gelb X-Strut yellow 42,4 63,6 84,8 106 169,6
	36370 35057	X-Strebe schwarz X-Strut black 63,6 106
	38538 38541 38540 38545 38531 35060	I-Strebe mit Loch, gelb I-Strut with bore, yellow 30 45 60 75 90 120



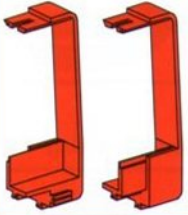

	36912 36913 36952 36923 38543 38546	I-Strebe mit Loch, schwarz I-Strut with bore, black 30 45 60 75 90 120
	36294 36293	Winkelträger 120 Angle girder 120 gelb/yellow schwarz/black
	36297 36921	Winkelträger 60 Angle girder 60 gelb/yellow schwarz/black
	36299 36920	Winkelträger 30 Angle girder 30 gelb/yellow schwarz/black
	35053 36922	Winkelträger 15 Angle girder 15 gelb/yellow schwarz/black
	36298 36950	Winkelträger 15 mit 2 Zapfen Angle girder 15 with 2 pins gelb/yellow schwarz/black
	35076 36973	Statikstein Statics building block gelb/yellow rot/red
	32850	Riegelstein 15x15 Building block 15x15
	35054	Flachträger 120 Flat girder 120
	35055	Bogenstück 60° Bow-shaped beam 60°
	36330	Bogenstück 30° Bow-shaped beam 30°
	36327	Flachstück 120 Beam 120
	35052	Winkelträger 7,5° Angle girder 7,5°
	36333	Laufschiene 240mm Guide rail 240mm

	35431	Platte 90x90 Plate 90x90
	36321	Platte 180x90 Plate 180x90
	36338	Platte 60x180 Plate 60x180
	32854 32968 36821	U-Träger 150 U-girder 150 schwarz / black rot / red blau / blue
	35979	U-Träger Adapter U-girder adapter
	32615	Anbauwinkel Building angle
	31013 36341	Flachstein 30 Flatblock 30 rot / red blau / blue
	31555 36342	Flachstein 60 Flatblock 60 rot / red blau / blue
	36596 36593	Grundplatte 45x45 Base plate 45x45 schwarz/black rot/red
	36576	Grundplatte 90x45 Base plate 90x45
	35129	Grundplatte 120x60 Base plate 120x60
	38236 38246 38263	Bauplatte 15x15 Mounting plate 15x15 gelb / yellow rot / red weiß / white
	38241 38267 38268	Bauplatte 15x30 Mounting plate 15x30 rot / red blau / blue gelb / yellow
	38242 38243 38261	Bauplatte 15x45 Mounting plate 15x45 rot / red gelb / yellow schwarz / black
	38324 38464 38474	Bauplatte 15x60 Mounting plate 15x60 blau / blue rot / red gelb / yellow

















	38244	Bauplatte 15x75 Mounting plate 15x75
	38245	Bauplatte 15x90 Mounting plate 15x90
	38259	Bauplatte 30x30 Mounting plate 30x30
	38237 38248	Bauplatte 30x45 Mounting plate 30x45 schwarz / black rot / red
	38249 38432	Bauplatte 30x60 Mounting plate 30x60 rot / red gelb / yellow
	38251 38485	Bauplatte 30x90 Mounting plate 30x90 rot / red gelb / yellow
	31124	Aufnahmeachse Holding axle
	36586	Radachse Wheel axle
	35405	V-Achse 4x80 V-Axle 4x80
	36574 36581 34994	Rad 23 Wheel 23 schwarz / black rot / red weiß / white
	34995	Reifen 32,5 Tyre 32,5
	31987 31986	Speichenfelge 23 Spoke rim 23 weiß / white gelb / yellow
	31237	Rennreifen 35 Racing tyre 35
	32228	Achsschenkel Steering knuckle
	32229	Spurstange R 30 Tie rods R 30
	32230	Lenkradhalter R 30 Steering wheel holder R 30
	31978	Sitzbaustein Seat building block

	35037	Kippmulde Dump body
	35038	Lager für Kippmulde Dump body bearing
	38443	Führerhaus 45 Cab 45
	32853 35806 36824	Teilebeutel ft-Männchen Bag with figure blau / blue blau/weiß / blue/white blau/weiß/blau / blue/white/blue
	31850 31854	Kappe Cap weiß / white gelb / yellow
	31909	Integral-Helm, weiß Integral helmet, white
	36825	Integral-Helm weiß, bedruckt Integral helmet white, printed
	31905	Visier Visor
	35998	Lenkklaue Steering claw
	31843	Lenkwürfel Steering block
	31894	Anlenkhebel Wrist pin
	38473	Lenkhebel Steering lever
	31614	Spurstange Track rod
	32884	Gelenkstange Hinged rod
	31888	Gelenkstück Articulated piece
	35068	Spurstangengelenk Track rod hinged

	32852	Lenkstock Steering column base
	32851	Lenksäule 34 Steering column 34
	32885	Lenksäule 78 Steering column 78
	35067	Lenksäule 65 Steering column 65
	31916	Lenkrad Steering wheel
	38472	Zahnspurstange Cogged track rod
	31141	Führerhaus Vorderteil Cab front section rot / red
	31143	Führerhaus Zwischenteil Cab middle section rot / red
	31145	Führerhaus Hinterteil Cab rear section rot / red
	32859 32860 32861	Bodenplatte 30x90 Bottom plate 30x90 rot / red blau / blue gelb / yellow
	32857 32858	Muldenseitenteil Trailer side section rot / red gelb / yellow
	32856 32855	Muldenklappe Trailer flap gelb / yellow rot / red
	31766 35051	Sitz Seat schwarz / black blau / blue
	31984	Schalensitz Bucket seat

	32870	Clipsachse Axle with clip
	35414	V-Achse 4x98 V-Axle 4x98
	32913	Reifen 50 Tyre 50
	32627 32883 36700	Felge Wheel rim gelb / yellow rot / red grün transparent / green transparent
	31913 35033	Nabenmutter Hub nut gelb / yellow rot / red
	35050 36820	Kotflügel Mudguard rot / red blau / blue
	31263	Aufliegerkupplung Unterteil Trailer coupling, bottom part
	31264	Aufliegerkupplung Oberteil Trailer coupling, upper part rot / red
	38446	Gelenkklau Articulated jaw for trailer coupling
	31081	Achshalter Axle mount
	31892 31760	Kunststoff-Feder 26 / Plastic spring 26 blau / blue schwarz / black
	31891	Federboden schwarz Spring base plate
	31997	Seilwindengestell Cable winch frame
	31998	Seilwindentrommel Cable winch drum
	31999	Seilwindenbremse Cable winch brake
	32973	Seiltrommelhalbschale Half shell of cable drum















	31016	Seiltrommel Winch drum
	31020	Klemmring für Seiltrommel Clamping ring for rope drum
	37636	Rollenlager Roller bearing
	35797	Seilrolle Ø21 Rope pulley Ø21
	38258	Seilrolle Ø12 Rope pulley Ø12
	31690	Rastachse 20 Clip axle 20
	32085	Rollenbock Roller block
	35668	Radhalter Wheel support
	36573	Rad 14 Wheel 14
	35404	V-Achse 4x17 rot V-Axle 4x17 red
	31390	Drehkranz-Oberteil Turntable top
	31391	Drehkranz-Unterteil Turntable case
	32886	Schneckenantrieb Worm drive
	35039 32869 31027	Seil Cable 600 mm 1200 mm 2000 mm
	38225	Seilhacken Hook
	31597	Abstandsring Spacer ring
	31983	Hülse 15 Sleeve 15
	37679	Klemmbuchse 5 Clip 5
	31023	Klemmbuchse 10 Clip 10
	31024	Klemmkupplung Axle coupling clip

	31058	Nabenmutter mit Scheibe Hub nut
	35031	Flachnabenzange Flat hub collet
	31017	Reifen 30 Tyre 30
	31018	Reifen 45 Tyre 45
	31026	Handkurbel Hand crank
	31019	Drehscheibe 60 Large pulley 60
	36331	Spurkranz Wheel flange
	36332	Gummiring für Spurkranz Rubber ring
	38413 38414 38415 38416	Kunststoffachse Plastic axle 30 40 50 60
	31034 31033 31032 37384 31040 31031 31036 31030 35696 35697	Metallachse Metal axle 30 50 60 80 90 110 125 150 170 200
	35112	Ritzel Z10, M1,5 Cog wheel T10, M1,5
	35146	Kegelrad Z12 Bevel gear T12
	35113	Spannzange Collet chuck
	31915	Zangenmutter Hub nut
	31054 31053	Zahnstange M1,5 Rack M1,5 30 60
	35694	Innenzahnrad Z30 Intertoothed gear T30



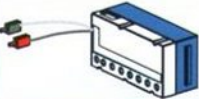











	35695	Zahnrad Z15 Gear wheel T15
	31021	Zahnrad Z20 Gear wheel T20
	36264	Zahnrad Z30 Gear wheel T30
	31022	Zahnrad Z40/32 Gear wheel T40/32
	31779	Kettenrad Z20 Chain wheel T20
	36248	Rastkettenglied Chain link
	32649	Beutel mit Rastkettenglied 152 Stück Bag with 152 chain links
	31762 31790	Rastraupenbelag Track link hart / hard weich / soft
	32656 36510	Beutel mit Rastraupenbelag, 76 Stück Bag with 76 chain links hart / hard weich / soft
	35466	Nockenscheibe schwarz Cam plate black
	35115	Getriebewürfel Gear cube
	35467	Getriebeklaue Gear claw
	35481	Power Motor 9V ∴ 1 A max Power Motor 9V ∴ 1 A max
	35090	Anbauplatte Power Motor Attachment plate, Power Motor
	35214	Zyl. – Schraube DIN 84 M 3 x 6 Cheese-head screw DIN 84 M 3 x 6
	35142	Abtriebshülse Power Motor Output sleeve, Power Motor
	35143	Differentialrad Power Motor Differential gear, Power Motor
	37858	Klemmbare Schnecke m=1,5 Locking worm m=1,5
	37926	Schneckenenteil m=1,5 Worm m=1,5

	37925	Schneckenmutter m=1,5 Worm nut m=1,5
	31711	Kontermutter m=1,5 Locknut m=1,5
	32293	S-Motor 6-9V ... S-Motor 6-9V ...
	31075	Getriebehalter mit Schnecke m=1,5 Gear support with worm m=1,5
	31078	U-Getriebe Motor reducing gearbox
	31063	U-Achse 60 mit Zahnrad Z28 Mini mot axle 60 with gear wheel T28
	31064	U-Achse 40 mit Zahnrad Z28 Mini mot axle 40 with gear wheel T28
	31082	Rastachse mit Zahnrad Z28, m=0,5 Clip axle with gear wheel T28, m=0,5
	37272	Zahnstangengetriebe m=0,5 Motor rack gearbox
	37457 37351	Zahnstange m=0,5 Rack & pinion 30 60
	35088	Gelenkkurbel Crank shaft
	35071	Rastkurbel Crank
	35063 35064 35065 35087 35066 37527	Rastachse Clip axle 30 45 60 75 90 180
	35061	Rastachse mit Kegelzahnrad Wheel axle with bevel gear
	35062	Kegelzahnrad mit Hülse Bevel gear with sleeve
	36227	Rastadapter Clip adapter















	35073	Rastkupplung Axle coupling
	35945	Rast-Ritzel Z10, m=1,5 Cog wheel T10, m=1,5
	37157	Impulsrad 4 Impuls wheel 4
	35072	Rastschnecke Worm
	35069	Seilwinden-Gestell 30 Cable winch frame 30
	35070	Seiltrommel für Rastachsen Cable winch drum
	35971	Kardangabel für Rastachsen Cardan yoke for wheel axles
	35972	Kardanwürfel Cardan cube
	35977	Rastachse mit Schnecke m=1 Clip axle with worm m=1
	35973	Schneckenmutter m=1 Worm nut M1,5
	31411	Differential Käfig Z26 Differential gear, cage Z26
	31414	Differential Antriebsrad Z14, m=1 Differential gear, driving wheel T14, m=1
	31412	Differential Planetenrad Z10 Differential gear, planet wheel T10
	31413	Differential Abtriebsrad Z10 Differential gear, driving wheel T10
	35982	Deckel für Differential Käfig Cover for differential cage
	35983	Zahnrad Z20 für Differential Käfig Gear wheel Z20 for differential cage
	30263	Akku/Batteriehalter Rechargeable battery holder Power-Block 7,2V... / 9V... für / for: 6 x 1,2V Mignon KR 15 / 51 AA oder / or 6 x 1,5V Mignon LR 06 (R6)
	35537	Akkupack NiCd 8,4 V 940 mA Rechargeable Battery Pack NiCd 8,4 V 940 mA

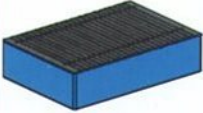

	32263 32252	Batteriegehäuse für 9V-Block Battery holder (9V) rot / red gelb / yellow
	32958 32253	Batteriegehäuse Deckel Cover for battery holder rot / red gelb / yellow
	32233	Batterieanschlußkontakt 9V ... Battery clip
	31253 31254	Flachbuchse montiert / Casing for flat plug grün / green rot / red
	31337 31336	Flachstecker montiert Flat plug rot / red grün / green
	36443	Schraubendreher Screwdriver
	36229 36210 36977 36382 31360 36035	Litze 2-adrig rot/grün Lead red/green 120 mm 250 mm 300 mm 1000 mm 2000 mm 7000 mm
	36983 35645	Litze 1-adrig schwarz Lead black 80 mm 2000 mm
	32404	Litze 1-adrig rot, 2000 mm Lead red, 2000 mm
	36121	Flip-Flop 9V ...
	30183	IR-Empfänger II 9V ... IR receiver II 9V ...
	35077 35078 35079 35084 35085 35086	Rastleuchtkappe Light cap blau / blue orange / orange rot / red grün / green gelb / yellow klarsichtig / transparent
	37869	Kugelstecklampe 9V ... 0,1 A Bulb lamp 9V ... 0,1 A
	37875	Linsenstecklampe 9V ... 0,15 A Lens tip lamp 9V ... 0,15 A

	38216	Leuchtstein mit Steckfassung Plug in light holder
	35604	Blinkelektronik 9V ... 0,8 A Electronic indicator 9V ... 0,8 A
	37783	Mini-Taster Mini switch
	36708	Polwendeschalter Reversing switch
	36134	Fototransistor montiert Photo transistor assembled
	36532	Störlichtkappe, Öffnung 6 Masking light cap, hole 6,0
	36119	Summer 6-9V ... Buzzer 6-9 V ...
	36120	Reedkontakt Reed contact
	35969	Reedkontakt und Kabelhalter Reed contact and cable clamp
	31323	Dauermagnet rot Permanent magnet
	37727	Schaltscheibe Index cam
	36437 36438	NTC-Widerstand NTC resistor 1,5 kΩ 68 kΩ 0,7 W
	35796 36147	Druckfeder Pressure spring 30x5x0,3 15x5x0,4
	32121	Faserstift Fiber pen insert
	31602	Kufe Skid
	31771	Lagerstück 1 Bearing unit 1
	31772	Lagerstück 2 Bearing unit 2
	35980	Klemmhülse Clip

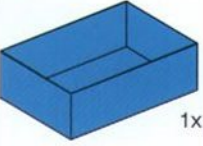
	35981	Hülse mit Scheibe Sleeve with nut
	35970	Schiebeteil Slide part
	35978	Roboterzange-Teil Gripper part
	36132	Achskappe Hub cap
	36906	Zylinder 15x30 Cylinder 15x30
	35389	Rohrhülse 30x43 Tubular sleeve 30x43
	31707 36703	Deckel Lid gelb schwarz
	31663 36702	Rohrhülse 30x60 Tubular sleeve 30x60 transparent / transparent schwarz / black
	37036	Aufkleber Junior Starter Junior Starter sticker
	37007	Aufkleber Racing Car Racing Car sticker
	37033	Aufkleber King of the Road King of the Road sticker
	35264	Klebeetikett Trucks Trucks sticker
	36216	Zahlenaufkleber 1-10 Number stickers 1-10
	36822	Klebeetikett big Junior big Junior sticker
	33582	Klebepunkt Self-adhesive disc
	36010	Gummiring Rubber ring
	35678	O-Ring für Drehscheibe 31019 O-Ring 54x3
	31912	Planierschild 150 Earth levelling scoop 150

	36925	Schaufel rot Shovel red
	36337	Luftschraube mit 4 Flügeln 4-blade propeller
	36559	Luftschraube 100 Propeller 100
	37681	Adapterspitze für Luftschrauben Pointed adapter for propellers
	36938	Pneumatik – Zylinder 60 Pneumatic cylinder 60
	36937	Kompressor – Zylinder 45 Compressor – cylinder 45
	36934	Pneumatik – Handventil Pneumatic hand – valve
	36970	Rückschlagventil schwarz Nonreturn valve black
	37003	Pneumatikschlauch 3m Pneumatic hose 3m
	36915	Winkelanschluß Angle connector
	31708	P – Stopfen P – plug
	31642	T – Stück T – piece
	36949	Kompressorkurbel Compressor crank
	36981	O – Ring 54 x 1,5 Silicon
	31422	Achsadapter Adapter
	32455	Führungsplatte E-Magnet Solenoid Guide Plate

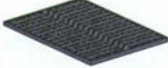
	36190	Luftspeicher Air accumulator
	35328	Schlauchanschluss Magnetventil Hose connection, solenoid valve
	35327	3/2-Wege Magnetventil 3/2-way solenoid valve
	37034	Doppelklebestreifen 14x60 Double adhesive strip 14x60
	37400	Solar modul 3 V, 240 mA Solar module 3 V, 240 mA
	37401	Goldcap 10F 2,3 V
	37403	Solar-Getriebemotor 2-3 V ... Solar geared motor 2-3 V ...
	37407	Solar Schalter Solar switch
	32076	Kassette 60x60 Bottom of cassette 60x60
	35360	Kassetten-Deckel Cassette cover
	30383	Box 1000 bestehend aus / consisting of:
	35937	Grundplatte 390x270 Base plate 390x270
	36497	Box 390x270
	36587	Sortierwanne 128x188 Innerbox 128x188
	36588	Zwischenwand Divider for innerbox

	30386	Box 500 bestehend aus / consisting of:
	32985	Grundplatte 258x186 Base plate 258x186
	36360	Box 258x186
	36356	Zwischensteg für Box 500, lang Divider for Box 500, long
	36357	Zwischensteg für Box 500, kurz Divider for Box 500, short

fischerwerke Artur Fischer GmbH & Co. KG
D-7 21 78 Waldachtal
Telefon 074 43/12 43 69 · Telefax 074 43/12 45 91
E-mail: fischertechnik-service@fischerwerke.de
<http://www.fischertechnik.de>

fischertechnik[®] [®]