



fischer **technik**® u-t 2

Handhabung der Bauelemente des Motors
und Getriebekastens



















Use of motor and gearbox kit parts

Manipulation des éléments de construction de la
boîte «moteur et engrenages»

Maneggio degli elementi della cassatta con motore
ed ingranaggi

Handleiding van de bouwelementen van de motor
en aandryngs doos

Stückliste u-t 2

	Artikel-Nr.	u-t 2 Stück	Bezeichnung		Artikel-Nr.	u-t 2 Stück	Bezeichnung
	331004 1	2	Baustein 30 mit Bohrung Building block 30 with bore Élément de 30 percé Elemento 30 con foro Bouwsteen 30 met boring		331015 1	1	Flachnabe Flat hub Moyeu plat Mozzo piatto Platte naaf
	431010 1	2	Winkelstein gleichseitig Angle block, equilateral Élément angulaire isocèle Elemento a triangolare equilatero Hoeksteen, gelijkzijdig		331308 1	1	Federgelenkstein Elbow-joint resilient Élément articulé à ressort Elemento snodata a molla Verende scharniersteen
	431011 1	4	Winkelstein gleichschenkelig Angle block, isosceles Élément angulaire équilatéral Elemento a triangolare Hoeksteen met gelijke benen		335756 1	4	Spurkranz mit Gummiring Flanged wheel with rubber ring Jante à boudin avec bandage caoutchouc Bordino con rivestimento di gomma Flenswiel met rubbering
	435697 3	1	Achse 200 · Axle 200 (8" approx.) Axe de 200 · Asse 200 · As 200		435694 1	1	Innenzahnrad Internal gearwheel Couronne dentée intérieure Ruota a dentatura interna Tandwiel met binnenvertanding
	435696 3	1	Achse 170 · Axle 170 (6 ⁵ / ₈ " approx.) Axe de 170 · Asse 170 · As 170		436264 1	2	Zahnrad Z 30 Gearwheel Z 30 Couronne à 30 dents Ruota dentata Z 30 Tandwiel Z 30
	431031 3	2	Achse 110 · Axle 110 (4 ¹ / ₄ " approx.) Axe de 110 · Asse 110 · As 110		431021 1	1	Zahnrad Z 20 Gearwheel Z 20 Couronne à 20 dents Ruota dentata Z 20 Tandwiel Z 20
	431032 3	2	Achse 60 · Axle 60 (2 ¹ / ₂ " approx.) Axe de 60 · Asse 60 · As 60		435695 1	2	Zahnrad Z 15 Gearwheel Z 15 Roue à 15 dents Ruota dentata Z 15 Tandwiel Z 15
	431034 3	2	Achse 30 · Axle 30 (1 ¹ / ₄ " approx.) Axe de 30 · Asse 30 · As 30		331047 1	1	Ritzel Z 10 mit Spannange Pinion with screw clamp Z 10 Roue à 10 dents m1,5 avec écrou de serrage Ingranaggio Z 10 Rondsel (klein tandwiel) met spantang Z 10
	431081 1	1	Achshalter · Axle holder · Support d'axe Supporto per assi · Ashouder		331051 1	2	Kegelzahnrad Bevel gearwheel Pignon conique à 12 dents m1,5 avec écrou de serrage Ruota dentata conica Kegeltandwiel
	331014 1	2	Nabe · Hub · Moyeu Mozzo · Naaf				

Stückliste u-t 2



















	Artikel-Nr.	u-t 2 Stück	Bezeichnung		Artikel-Nr.	u-t 2 Stück	Bezeichnung
	3310231	8	Klemmbuchse Spring clip Bague de serrage Bussola di fissaggio Klembus		3310491	1	Achse 110 mit Zahnrad Z 44 Axle 110 (4 1/2") with gearwheel Z 44 Axe de 110 avec roue à 44 dents Asse 110 con ruota dentata Z 44 As 110 mit tandwiel Z 44
	4310571	2	Raupenband Caterpillar track Chenille Cingolo Rupsband		3310501	1	Achse 50 mit Zahnrad Z 44 Axle 50 (2") with gearwheel Z 44 Axe de 50 avec roue à 44 dents Asse 50 con ruota dentata Z 44 As 40 met tandwiel Z 44
	4310371	1	Segmentscheibe Segment disc Came avec denture latérale Disco eccentrico den dater Segmentschijf		3310431	1	Differentialgetriebe Differential gearbox Différentiel Ingranaggio differenziale Differentieel
	3310441	1	Kardangelenk Universal joint Cardan Guinto cardanico Kardaandrijving		3313071	4	Federfuß · Spring leg · Jambe élastique Piedino a molla · Verende roct
	4310531	6	Zahnstange 60 Gear-rack 60 (2 1/2") Crémaillère de 60 Asta dentata 60 Tandstang 60		3365181	1	Kassette · Case · Coffret Cassetta · Cassette
	3310391	1	Motor 6 V Motor 6 V Moteur courant continue 6 V Motore 6 V Motor 6 V		3313381	4	Klemmkontakt · Clamping contact Contact à clip · Contatto a molletta Klemkontakt
	3310481	1	Stufengetriebe Reduction gearbox Réducteur de vitesse Ingranaggio progressivo Reductiekast		4357967	4	Druckfeder 30 · Pressure spring 30 Ressort à compression de 30 Molla a pressione 30 · Drukveer 30
	3310451	1	Getriebebock mit Schnecke Bracket with worm Réducteur à vis Supporto con vite senza fine Asdrager met worm		4362631	100	Kettenglied · Chain-link · Chaînon Anello dicatena · Kettingschakel
	3310461	1	Getriebebock ohne Schnecke Bracket without worm Réducteur Supporto con asse Asdrager zonder worm		4363341	8	Riegelscheibe · Blocking washer Disque d'arrêt · Disco a tacche Grendelschijf
					3354191	1	Kabel zweiadrig blau 1000 · Cable double blue 1000 · Câble double bleu 1000 Cava 2 fili blu 1000 · Kabel bl 1000

Abb. 1-2 Anschluß des Motors an eine Stromquelle
Abb. 3-5 Montage des Motors auf Grundplatte
Abb. 6 Anbau von Schnecke und Getriebeblock

Fig. 1-2 Connection of motor to a power source
Fig. 3-5 Mounting of motor on base plate
Fig. 6 Mounting of worm and gear stand

Fig. 1-2 Branchement du moteur à une source de courant
Fig. 3-5 Montage du moteur sur plaque de base
Fig. 6 Fixation de la vis sans fin et du réducteur

III. 1-2 Collegamento del motore con una fonte di energia
III. 3-5 Montaggio del motore sulla piastra fondamentale
III. 6 Innesto del supporto con ingranaggi e vite senza fine

Afb. 1-2 Aansluiting van de motor aan een stroombron
Afb. 3-5 Montage van de motor op de basisplaat
Afb. 6 Monteren van wormwiel en aandryfstuk

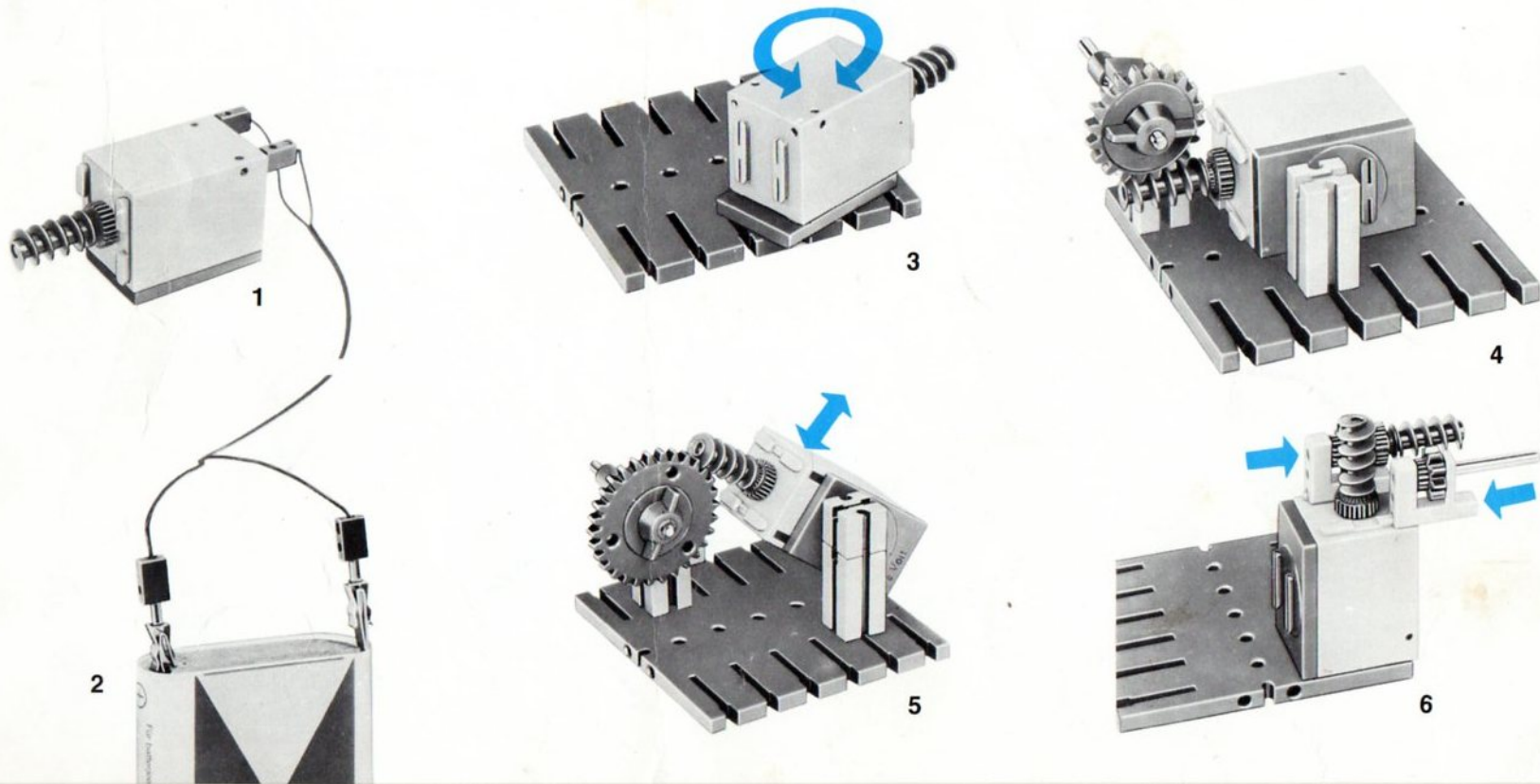

- Abb. 7 Motorwelle mit Schnecke, Schnurlaufscheibe und Zahnrad
 Abb. 8 Schneckengetriebe
 Abb. 9 Stirnräder; Zusammenstellung in verschiedenen Größen
 Abb. 10–13 Verschiedene Getriebeabstufungen durch Umstecken der Zahnräder

- Fig. 7 Motor shaft with worm, pulley and gear wheel
 Fig. 8 Worm gear
 Fig. 9 Spur gears; assembly in different sizes
 Fig. 10–13 Different gear reductions by changing gear wheels

- Fig. 7 Arbre de moteur avec vis sans fin, gorge de guidage pour câble et roue dentée
 Fig. 8 Renvoi d'angle avec vis sans fin
 Fig. 9 Différentes roues dentées.
 Fig. 10–13 Différentes graduations du réducteur par déplacement des roues dentées

- III. 7 Albero del motore con vite senza fine, disco per trasmissioni con funicella e ruota dentata
 III. 8 Ingranaggio a vite senza fine
 III. 9 Ruote dentate cilindriche, assortimento di varie dimensioni
 III. 10–13 Vari rapporti di trasmissione per mezzo di interscambio delle ruote dentate

- Afb. 7 Motorworm met aansluitstuk, kabelschijf en tandwiel
 Afb. 8 Aansluitstukaandrijving
 Afb. 9 Rechte tandwielen; samenstelling in verschillende groottes
 Afb. 10–13 Verschillende trapsgewysgemaakte aandrijvingen door middel van verplaatsen van de tandwielen

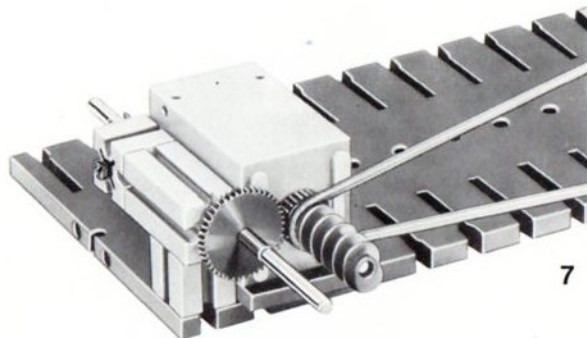

7

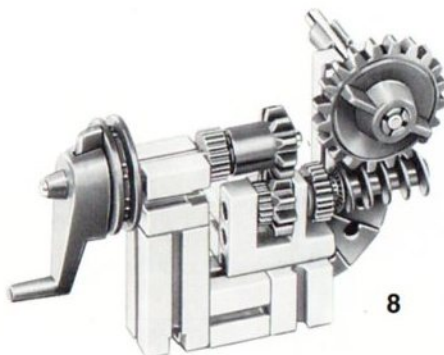

8

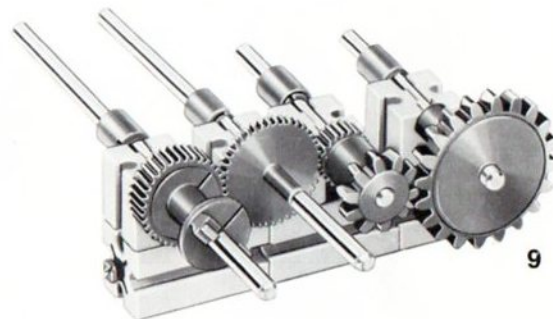

9

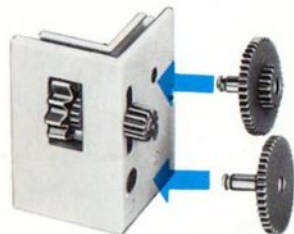

10



11

(32:1)



12

(77:1)

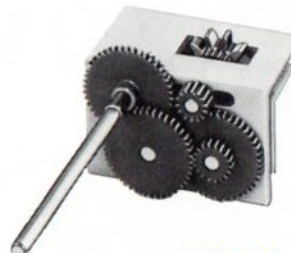

13

(240:1)

Abb. 14–15 Anbau des Getriebewinkels
 Abb. 16 Verschiedene Stirnradübersetzungen
 Abb. 17–18 Die Segmentscheibe mit Mitnehmerstift und Verzahnung
 Abb. 19–20 Zahnrad Z 30, Verbindung mit anderen Bauelementen

Fig. 14–15 Mounting of gear angle
 Fig. 16 Different spur gear ratios
 Fig. 17–18 The segmental wheel with drive pin and toothing
 Fig. 19–20 Gearwheel Z 30, connection with other components

Fig. 14–15 Fixation de réducteur
 Fig. 16 Différentes démultiplications
 Fig. 17–18 Came à segment avec broche d'entraînement et denture
 Fig. 19–20 Couronne Z 30 assemblée avec d'autres éléments de construction

III. 14–15 Innesto del supporto dell ingranaggio
 III. 16 Varie trasmissioni per mezzo di ruote dentate coniche
 III. 17–18 Il disco a segmenti con nottolino di trascinamento e dentatura
 III. 19–20 Ruota dentata Z 30, collegamento con altri elementi

Afb. 14–15 Montage van aandryfhoekstuk
 Afb. 16 Verschillende rechte tandwiel overbrengingen
 Afb. 17–18 De segmentschijf met meenemerstift en vertanding
 Afb. 19–20 Tandwiel Z 30, verbinding met andere bouwelementen

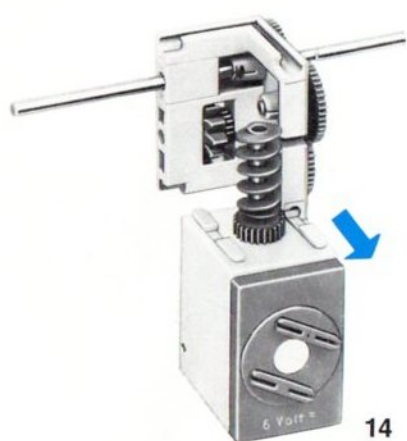

14

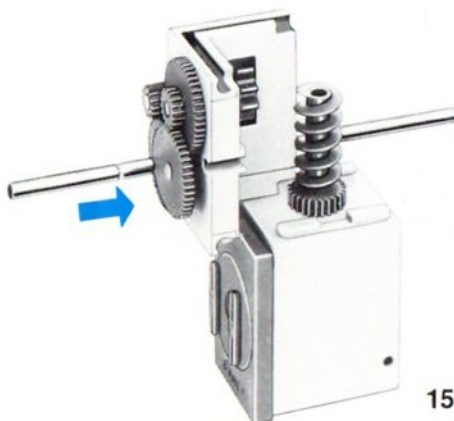

15



17



18



19



16



20

Abb. 21–23 Montage und Befestigung der Kette
 Zahnräder Z 40, Z 30, Z 20 und Drehscheibe als Laufräder
 Abb. 28–30 Montage des Zahnrades Z 15 in Verbindung mit Elementen mit Klemmverschraubung

Fig. 21–23 Mounting and fixing of chain
 Fig. 24–27 Gear wheel Z 40, Z 30, Z 20 and rotary disk as running wheels
 Fig. 28–30 Mounting of gear wheel Z 15 together with elements with clamping joints

Fig. 21–23 Montage et fixation de la chaîne
 Fig. 24–27 Couronnes Z 40, Z 30, Z 20 et plaque tournante utilisées comme roue de roulement
 Fig. 28–30 Couronne Z 15 avec des éléments de serrage

III. 21–23 Montaggio e fissaggio della catena
 III. 24–27 Ruote dentate Z 40, Z 30, Z 20 e disco girevole in funzione di ruote portanti
 III. 28–30 Montaggio della ruota dentata Z 15 in collegamento con altri elementi con avviteamento d'arresto

Afb. 21–23 Montage en bevestiging van de ketting
 Afb. 24–27 Tandwielen Z 40, Z 30, Z 20 en draaischijf als loopwielen
 Afb. 28–30 Montage van tandwiel Z 15 in verbinding met elementen met klemverschroefing

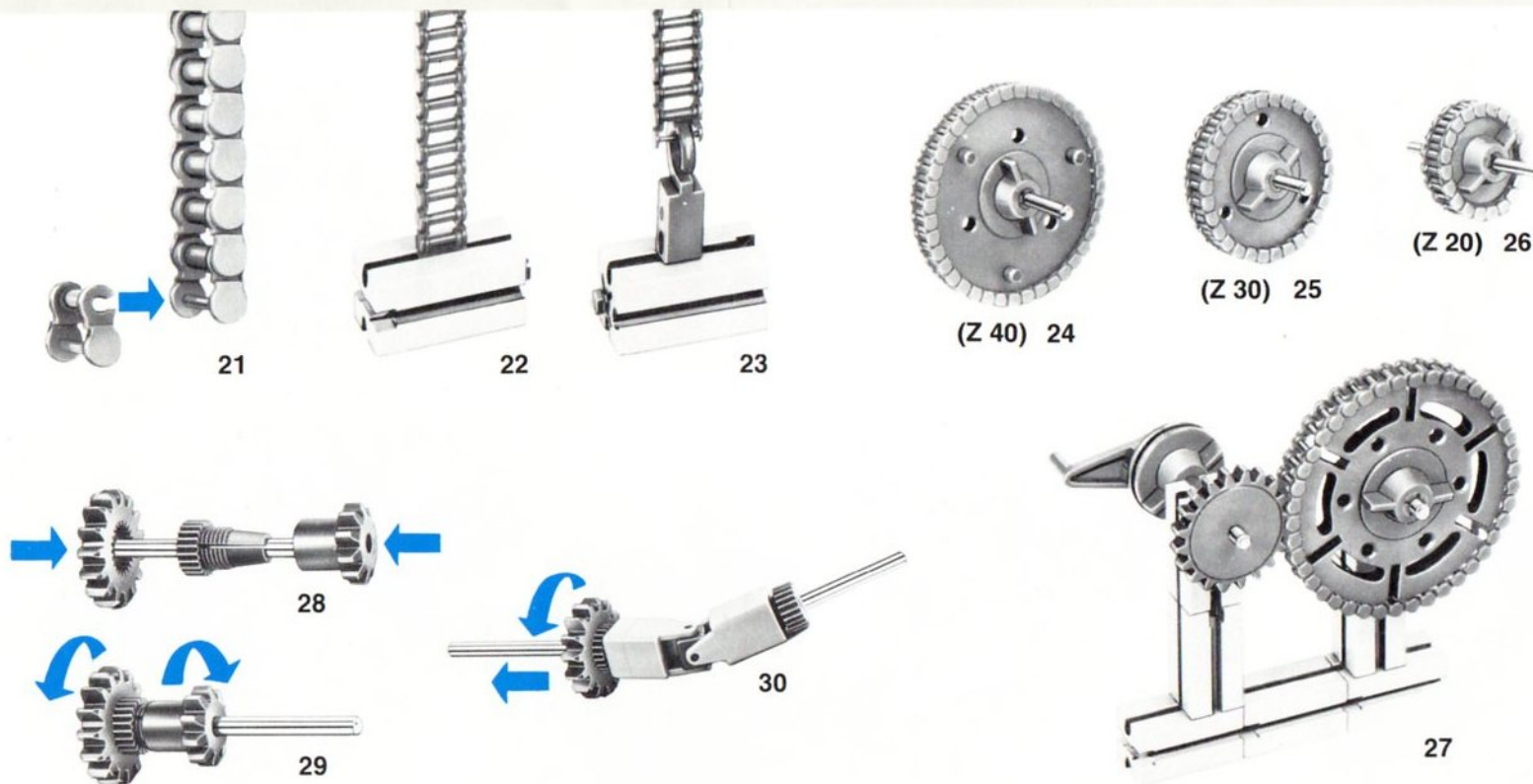

- Abb. 31 Kette als Zugmittel
 Abb. 32-33 Federgelenkstein; Anwendung als Sperrklinke und Kettenspanner
 Abb. 34.1 Differentialgetriebe
 Abb. 34.2 Schnitt durch das Differentialgetriebe
 Abb. 35 Anbau des Differentialgetriebes
- Fig. 31 Chain as traction element
 Fig. 32-33 Resilient joint; use as pawl and chain tensioning element
 Fig. 34.1 Differential gear
 Fig. 34.2 Cross section through differential gear
 Fig. 35 Mounting of differential gear
- Fig. 31 Chaîne comme moyen d'entraînement
 Fig. 32-33 Élément articulé à ressort utilisé comme cliquet anti-retour et tendeur de chaîne
 Fig. 34.1 Différentiel
 Fig. 34.2 Coupe du différentiel
 Fig. 35 Montage du différentiel

- III. 31 Catena in funzione di mezzo di trazione
 III. 32-33 Elemento snodato a molla, in funzione di nottolino d'arresto e tendicatena
 III. 34.1 Ingranaggio differenziale
 III. 34.2 Sezione dell'ingranaggio differenziale
 III. 35 Innesto dell'ingranaggio differenziale
- Afb. 31 Ketting als trekhulpmiddel
 Afb. 32-33 Veerscharniersteen; gebruik als remklink en kettingspanner
 Afb. 34.1 Differentieelaandrijving
 Afb. 34.2 Doorsnede van differentieelaandrijving
 Afb. 35 Monteren van de differentieelaandrijving

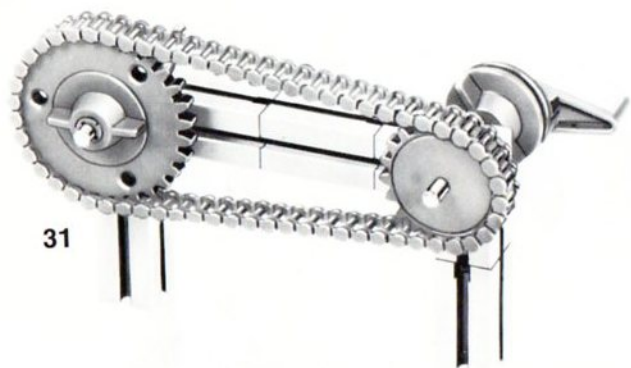

31



32



33

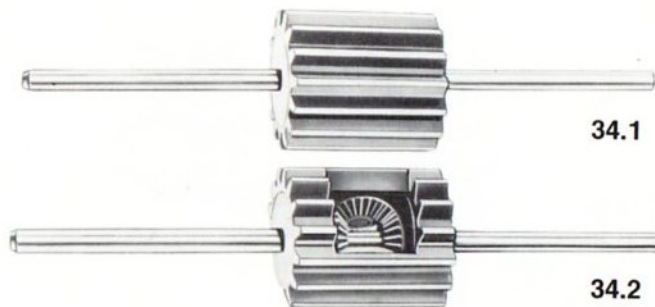

34.1

34.2

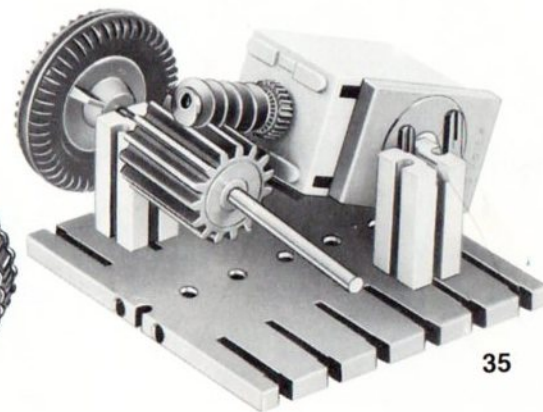

35

Abb. 36-38 Federfuß; Einbau und Anwendung als Radfeder
 Abb. 39 Gummiring zur Erhöhung der Reibung bzw. Bodenhaftung der Reifen
 Abb. 40 Raupenband als Zugmittel
 Abb. 41 Riegelscheiben als Distanzscheiben
 Abb. 42 Spurkranzrad und Laufschiene
 Abb. 43 Anwendung der Federfüße als Sperrklinke

Fig. 36-38 Spring leg; mounting and use as wheel spring
 Fig. 39 Rubber ring to increase friction or grip of tyres
 Fig. 40 Caterpillar track as traction element
 Fig. 41 Holding disks as spacer disks
 Fig. 42 Flange wheel and rail
 Fig. 43 Use of spring leg as pawl

Fig. 36-38 Jambe élastique utilisée comme suspension
 Fig. 39 Bandage caoutchouc pour augmenter l'adhérence des pneus
 Fig. 40 Chenillette comme moyen d'entraînement
 Fig. 41 Disque d'arrêt utilisé comme pièce d'écartement
 Fig. 42 Jante à boudin et rail plat
 Fig. 43 Utilisation de la jambe élastique comme cliquet anti-retour

III. 36-38 Piedino a molla, modo di montaggio ed applicazione in funzione di molleggio della ruota
 III. 39 Anello elastico per maggiore attrito opp. aderenza al terreno
 III. 40 Cingolo come mezzo di trazione
 III. 41 Rondelle di fissaggio in funzione di dischetti di spessore
 III. 42 Ruota a bordino e rotaia
 III. 43 Applicazione dei piedini a molla in funzione di nottolini d'arresto

Afb. 36-38 Verende roet; inbouw en gebruik als wielveer
 Afb. 39 Gummiring voor de verhoging van de wrijving zone als bodemhechting van de bandel
 Afb. 40 Rupsband als trekmiddel
 Afb. 41 Grendelschijf als afstandsschijf
 Afb. 42 Flenswiel en dubbelrail
 Afb. 43 Gebruik van de veervoet als remklink



Abb. 44-49 Innenzahnrad; Anbau und Lagerung
Abb. 50-51 Beispiele einfacher Planetengetriebe

Fig. 44-49 Internal gear wheel; mounting and bearing
Fig. 50-51 Examples of simple planetary gearing

Fig. 44-49 Roue à denture intérieure; assemblage et logement
Fig. 50-51 Exemples d'engrenages planétaires

III. 44-49 Ruota a dentatura interna, innesto e sistema di supporto
III. 50-51 Esempi di semplici ingranaggi planetari

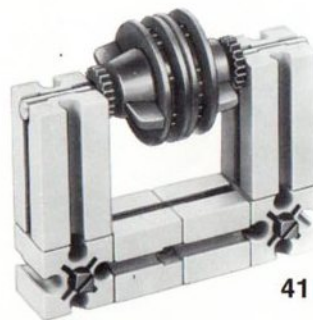
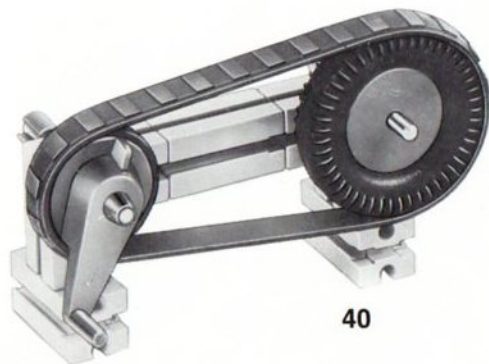
Afb. 44-49 Binnentandwiel; inbouw en ligging
Afb. 50-51 Voorbeelden van eenvoudige planetenaandrijving



44



45



46

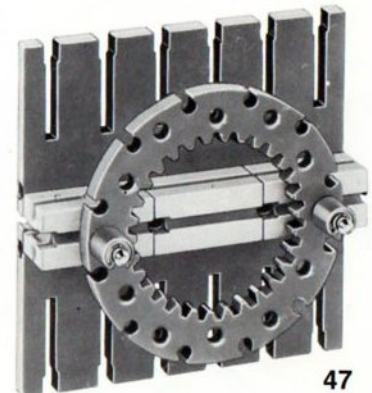

47



48



49

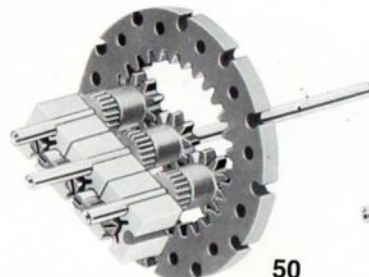

50

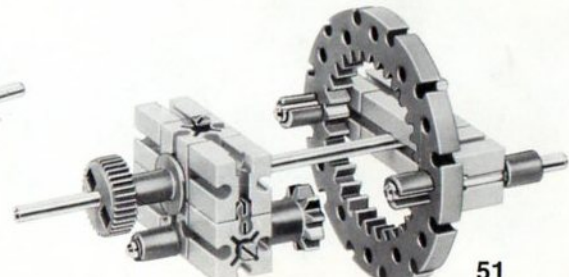

51