



## 50 S/1

Aufbau-Statikkasten  
structural  
extension kit  
boîte complémentaire  
«superstructure»  
cassetta statica  
d'integrazione  
aanbouw statikadoos



Art.-Nr. 6 39121 5

Aufbaustufen  
der fischertechnik-  
Statikkästen

extension packs for  
fischertechnik structural  
sets

possibilités d'extension  
des boîtes «superstructure»  
fischertechnik  
fasi d'ampliamento delle  
cassette fischertechnik  
statica

uitbreidingsfasen van  
de fischertechnik  
statikadozen

▶  $100\text{ S} = 50\text{ S} + 50\text{ S}/1$   
 $200\text{ S} = 50\text{ S} + 50\text{ S}/1 + 50\text{ S}/2$   
 $300\text{ S} = 50\text{ S} + 50\text{ S}/1 + 50\text{ S}/2 + 50\text{ S}/3$



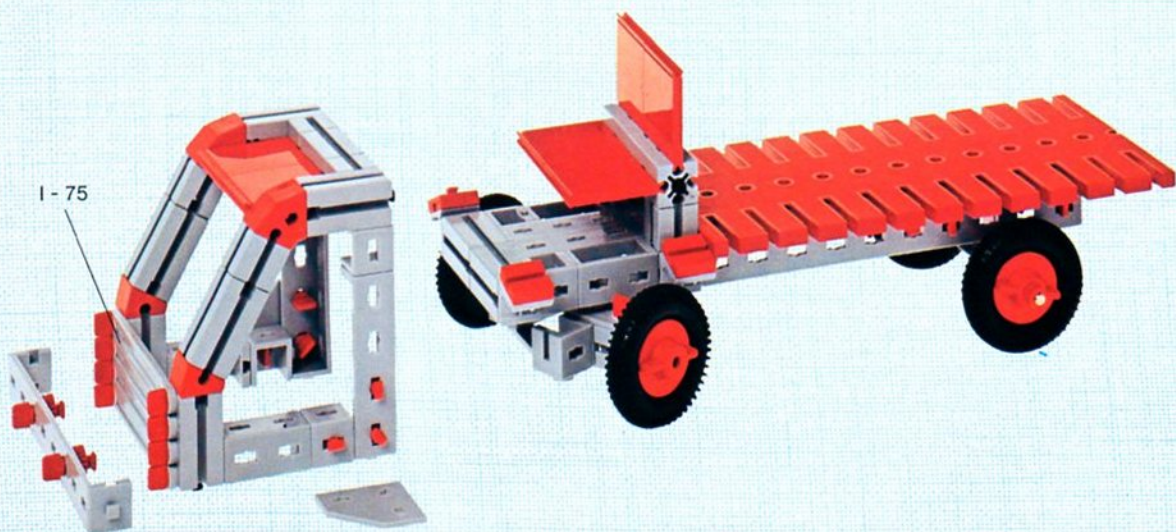
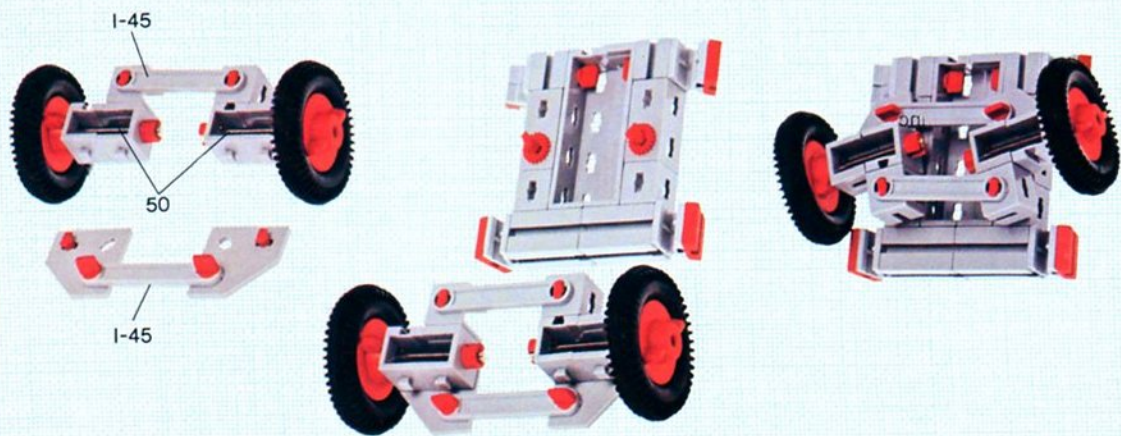



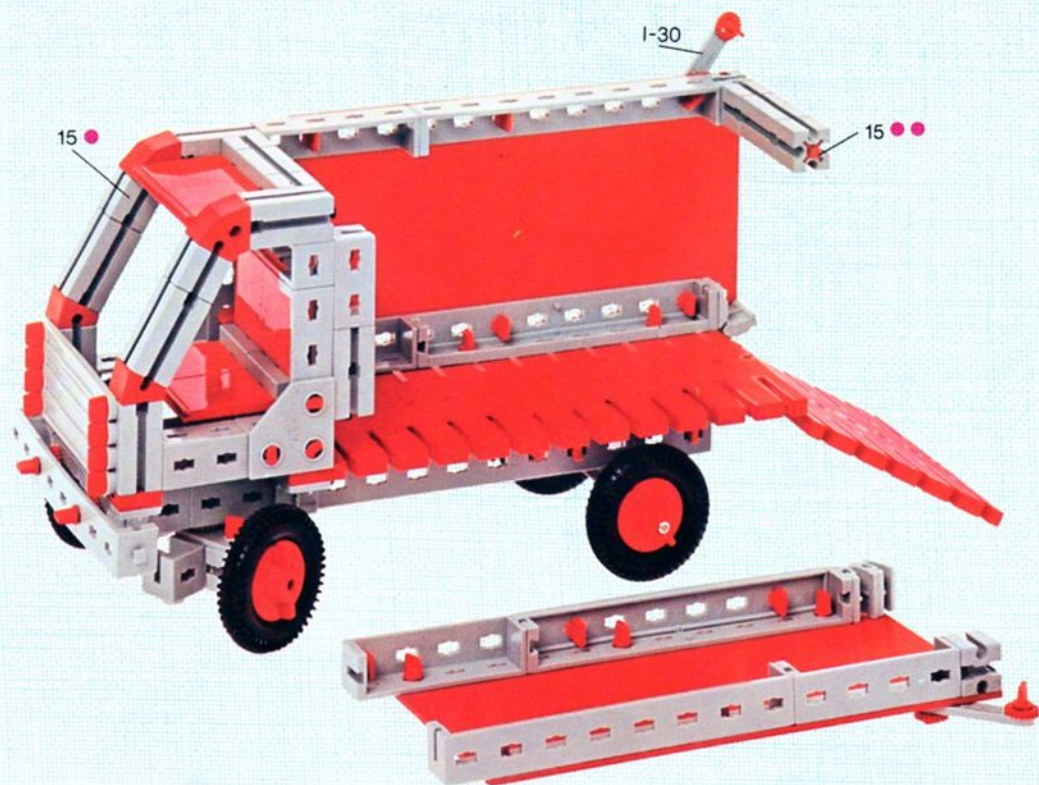



Zusammenfügen des Flachträgers mit Flachstück  
Connecting the flat girders with flat

Assemblage de la cornière plate avec un raccord plat  
Collegamento di piastre nodali e diagonali  
Samenvoegen van de vlakke draagsteun  
met vlakke steun

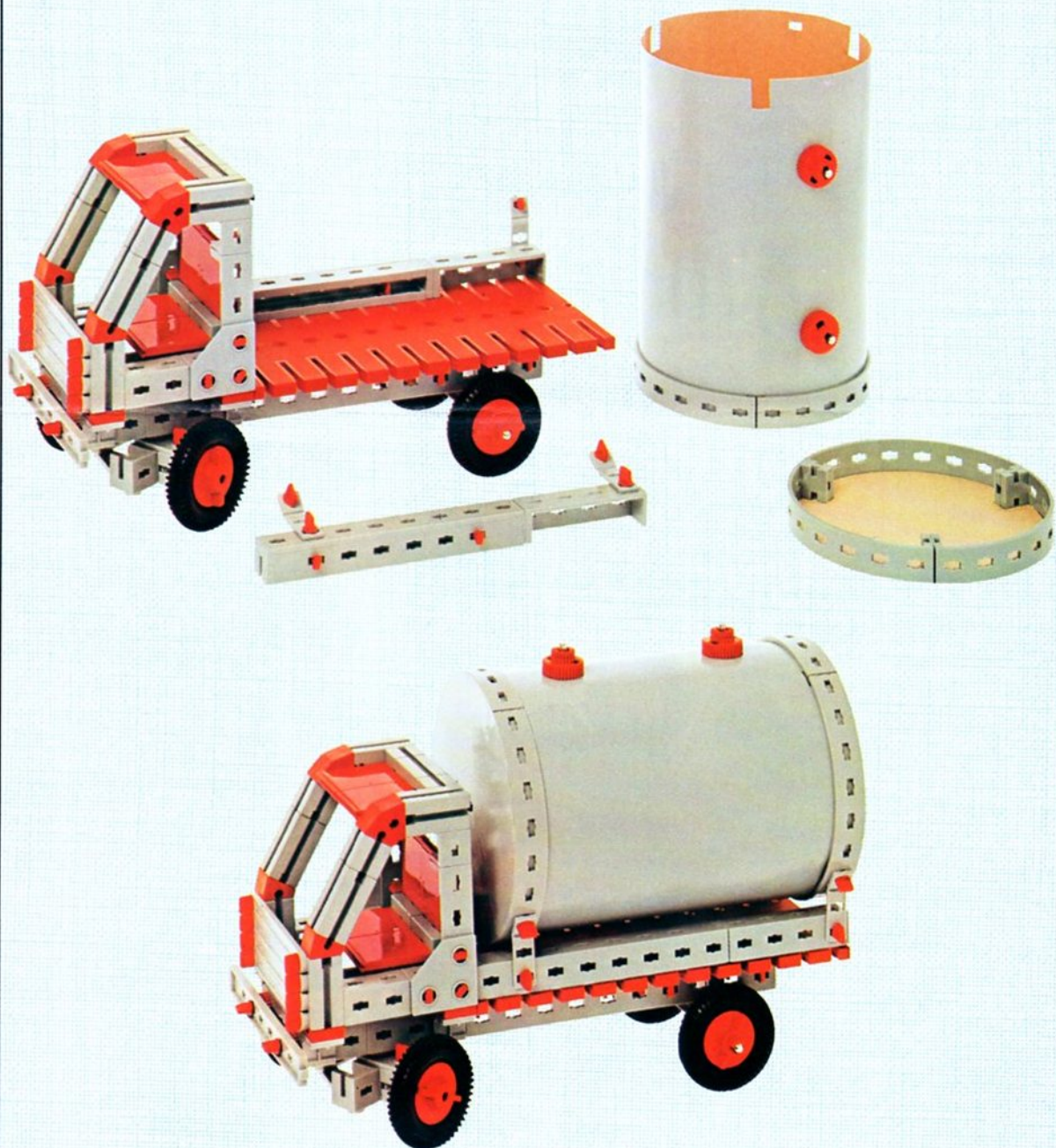



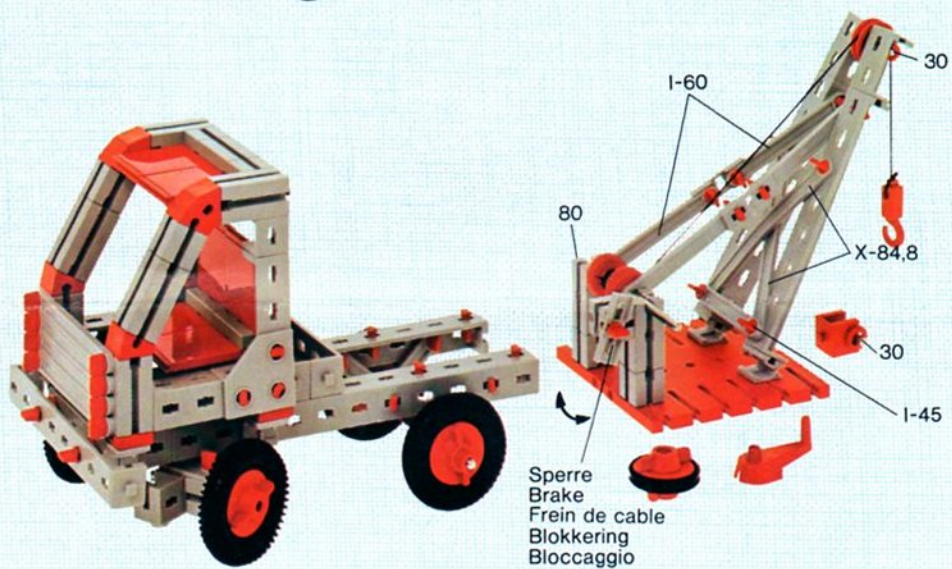
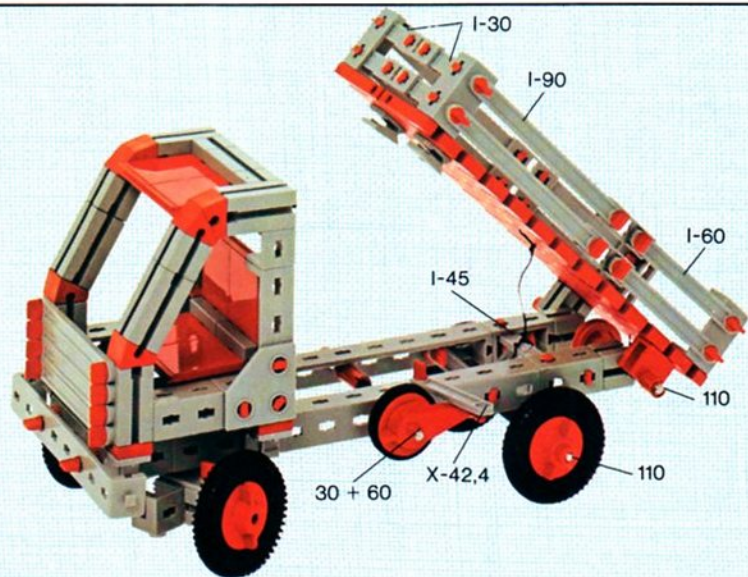



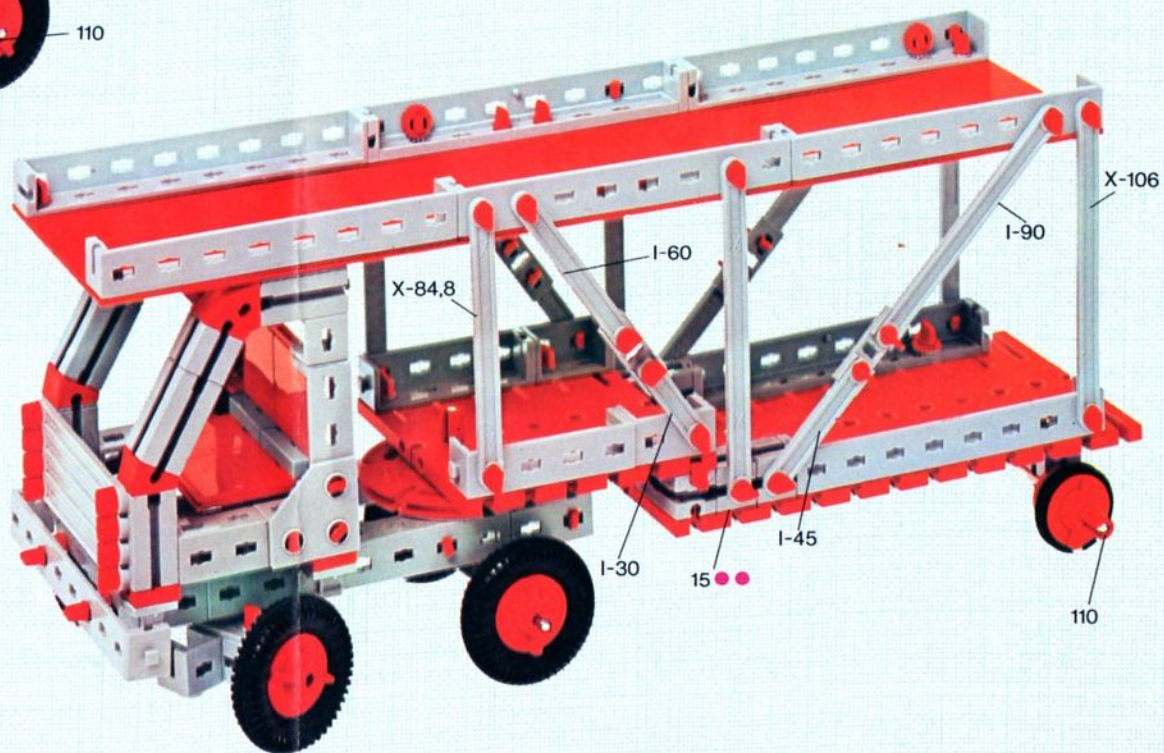
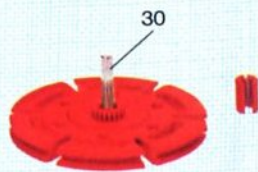



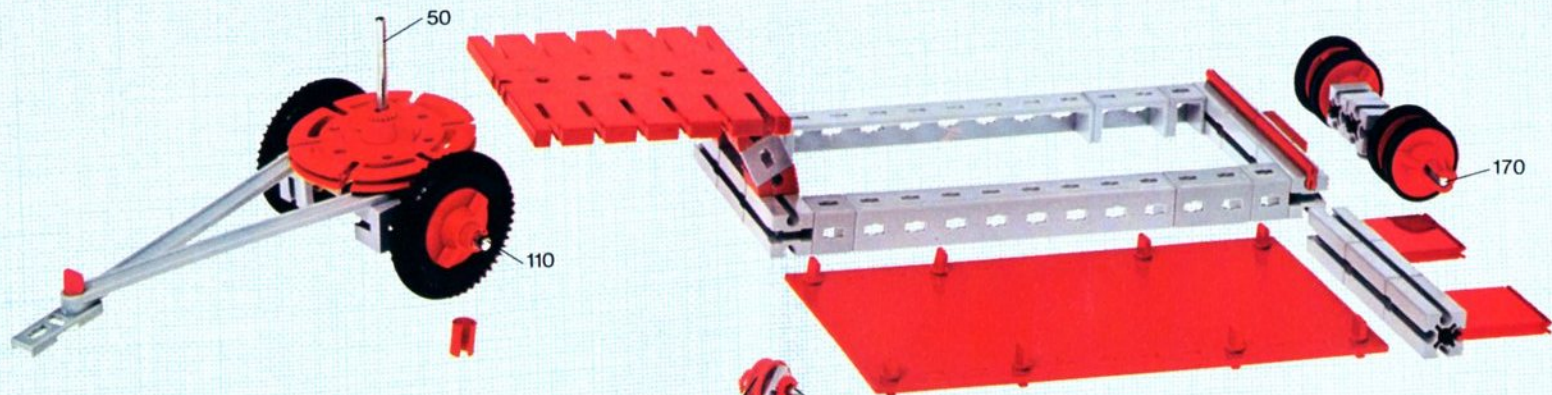



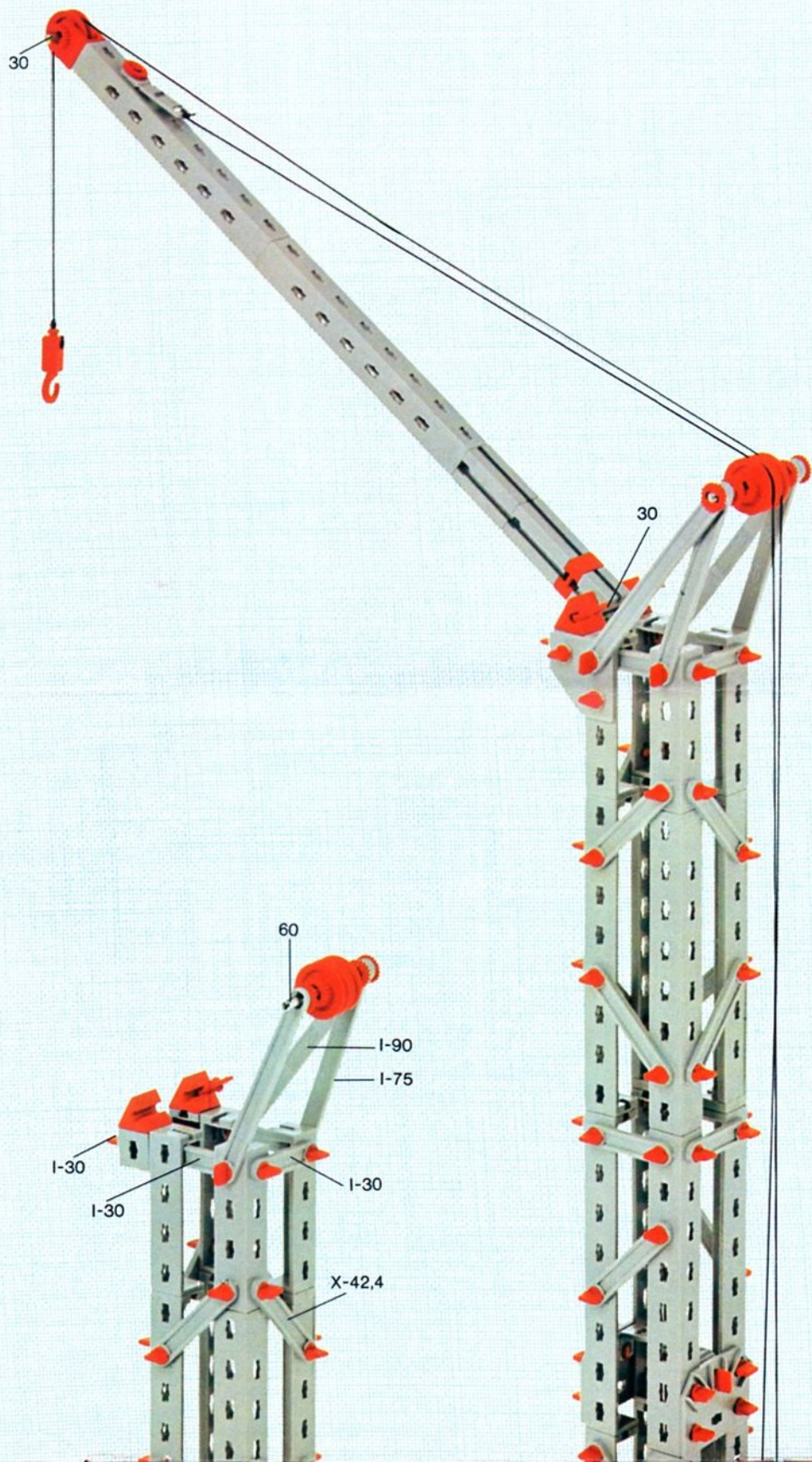

Sperre  
Brake  
Frein de cable  
Blokering



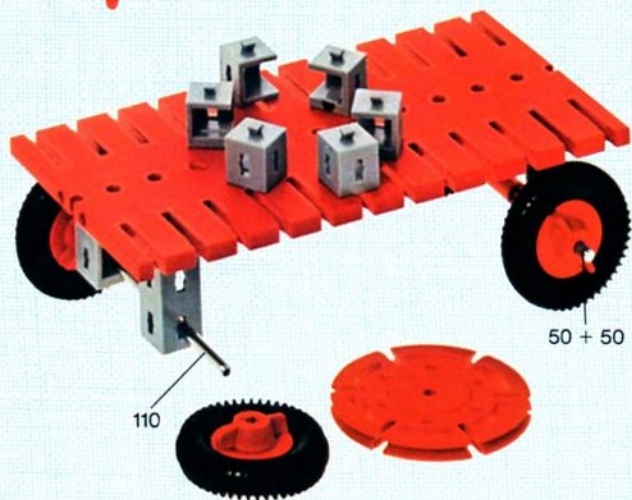
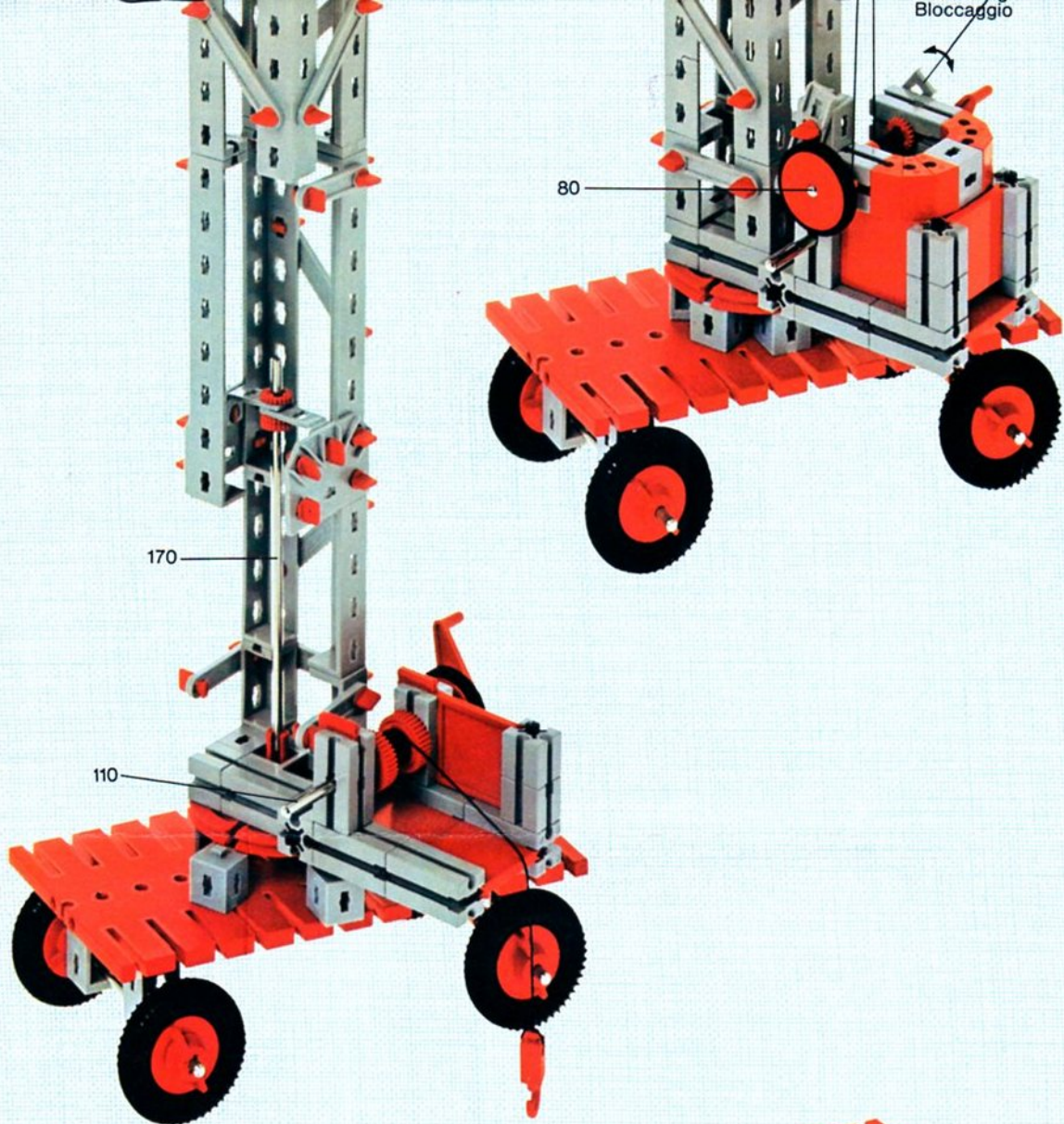



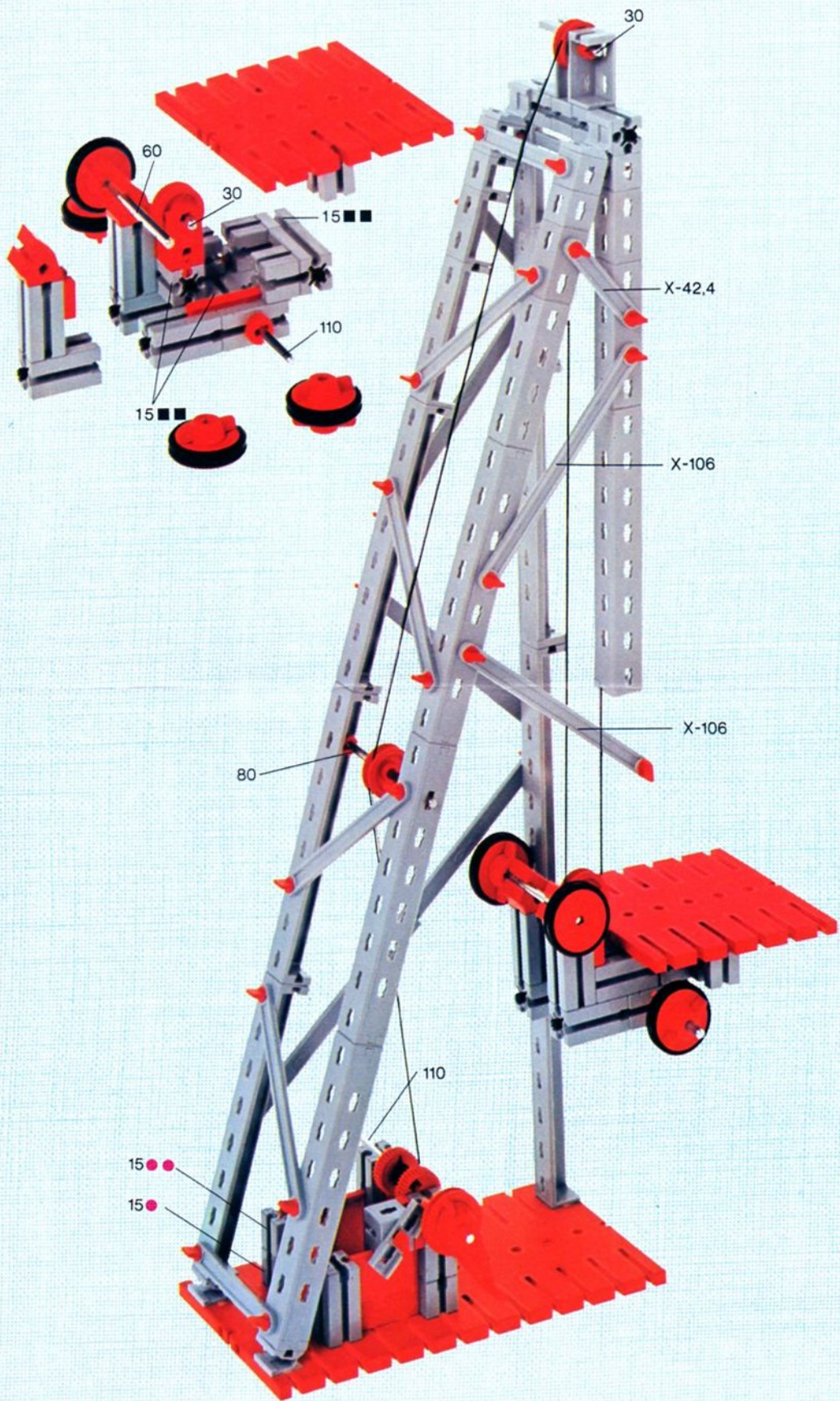



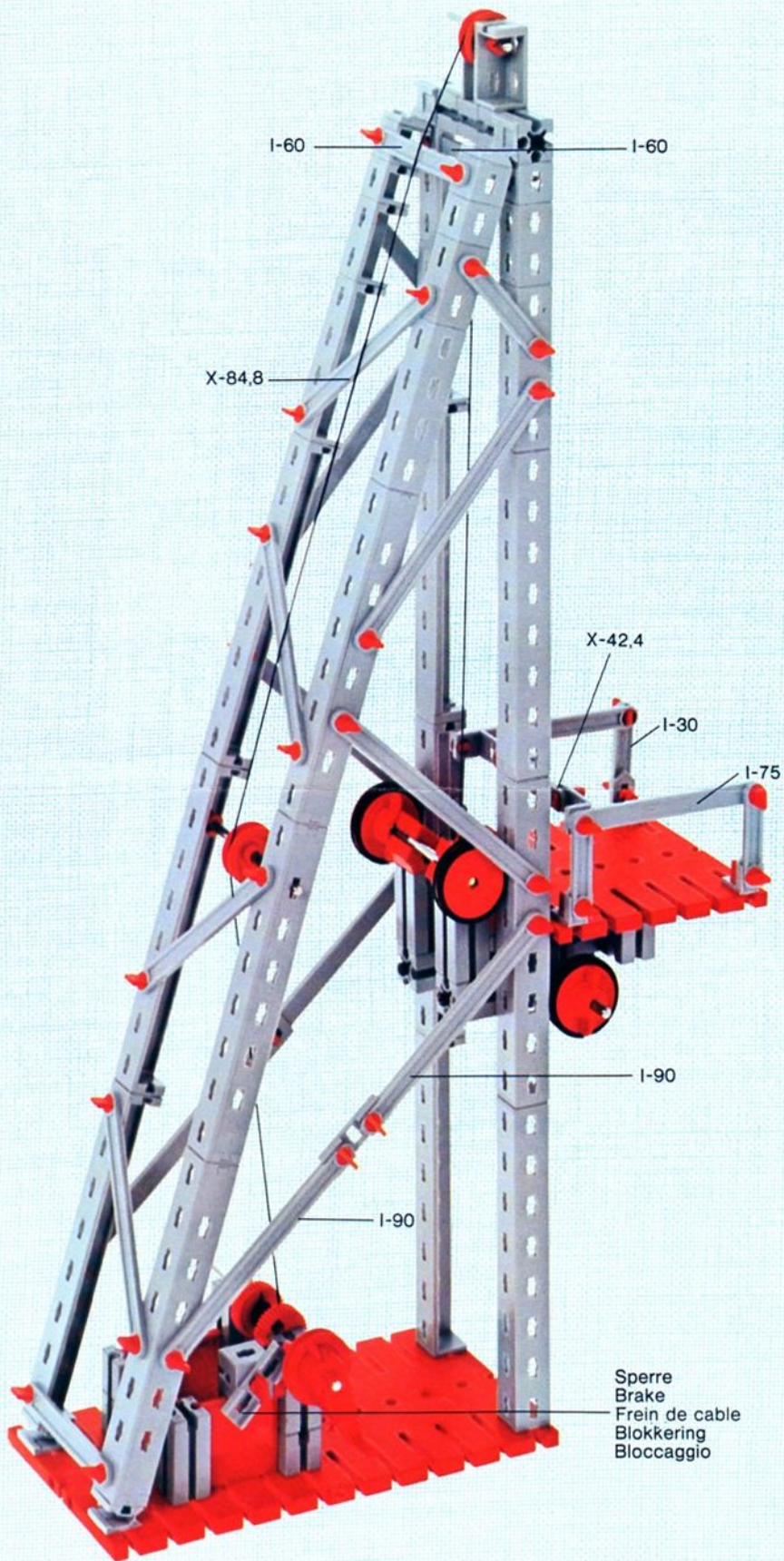



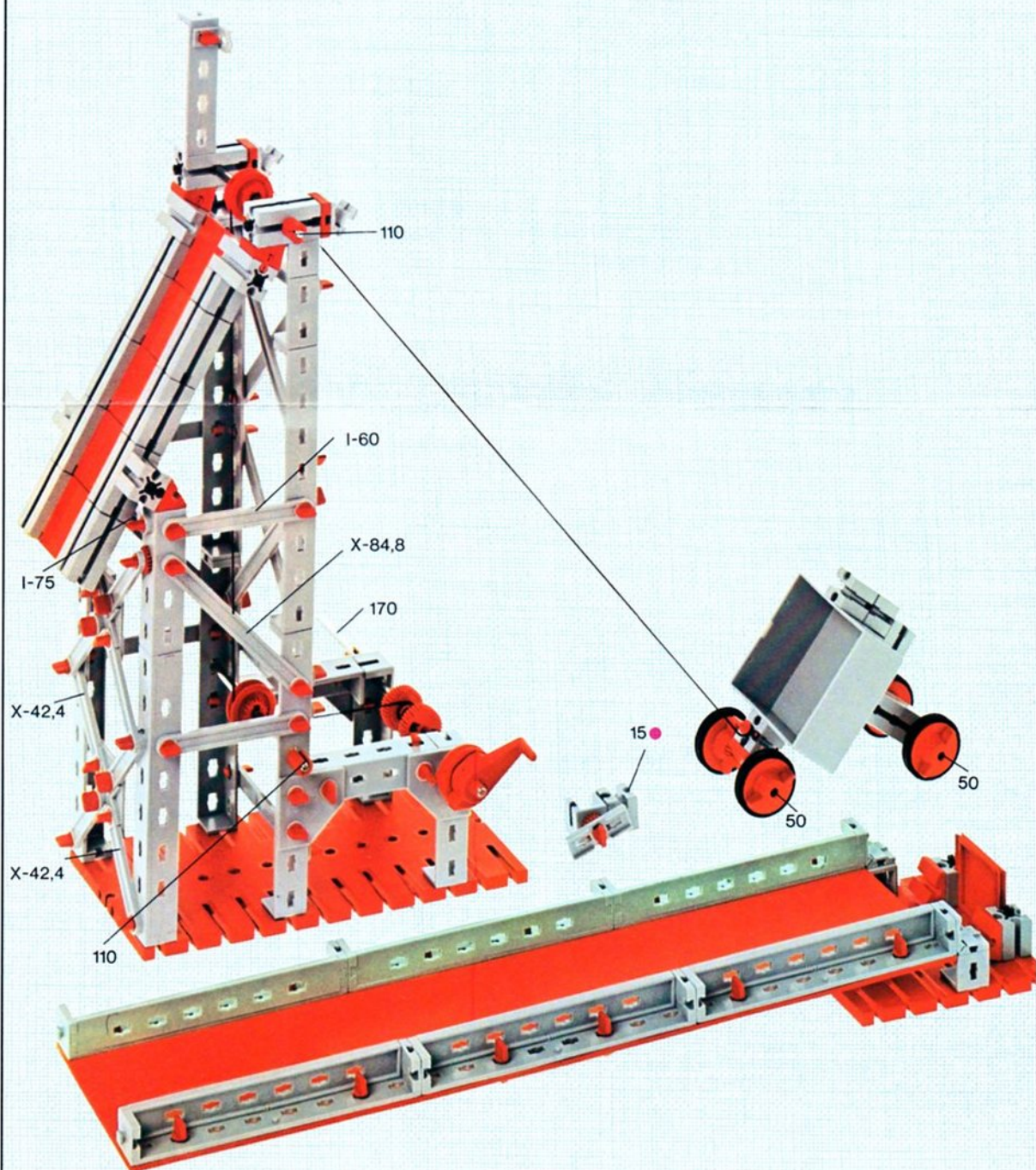



Schrägaufzug mit Kippvorrichtung  
Inclined lift with tipping device  
Monte-charge liné avec mécanisme basculant  
Hijswerktuig in schuine richting met kiptoestel  
Piano inclinato con dispositivo ribaltabile

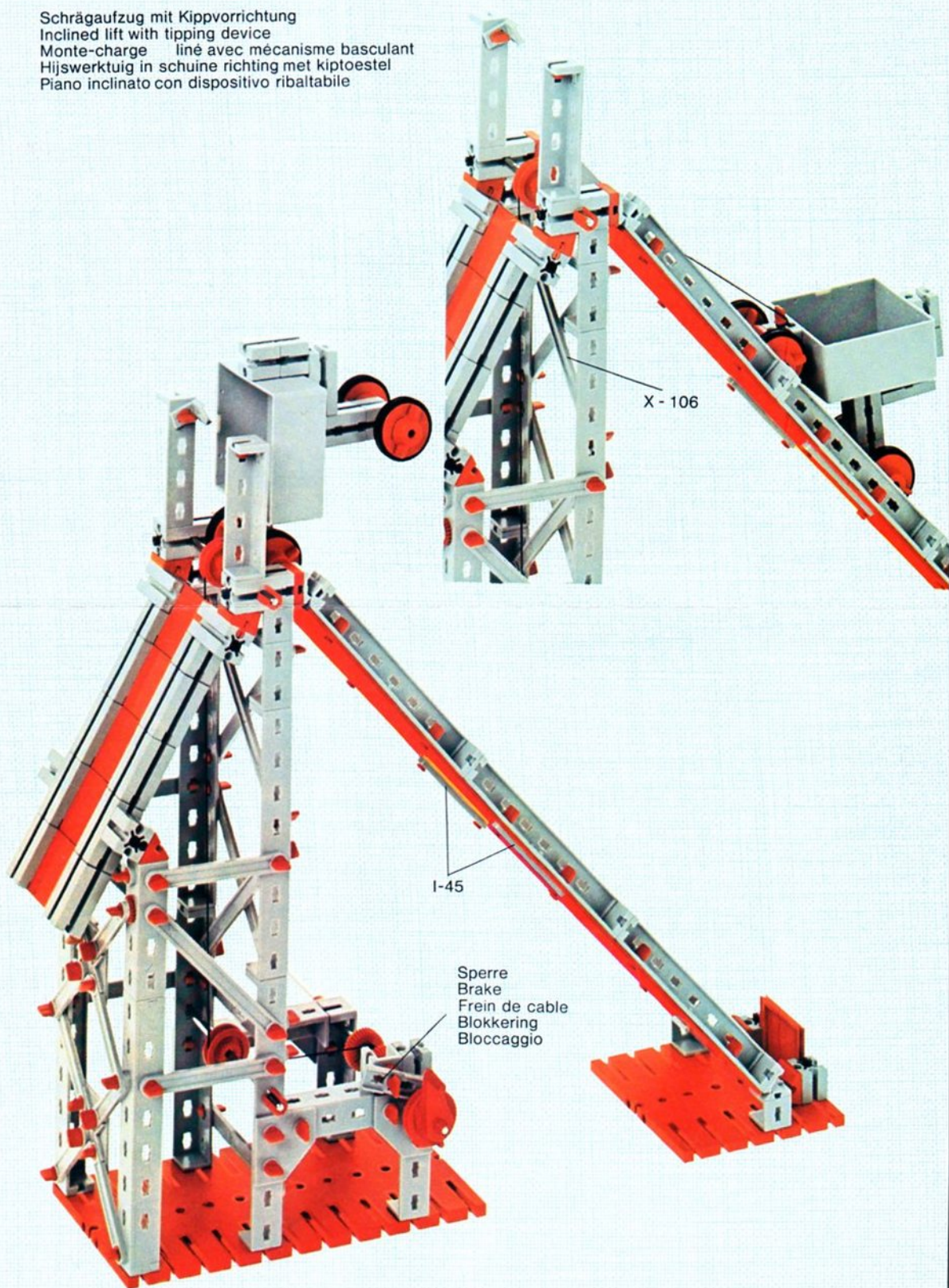





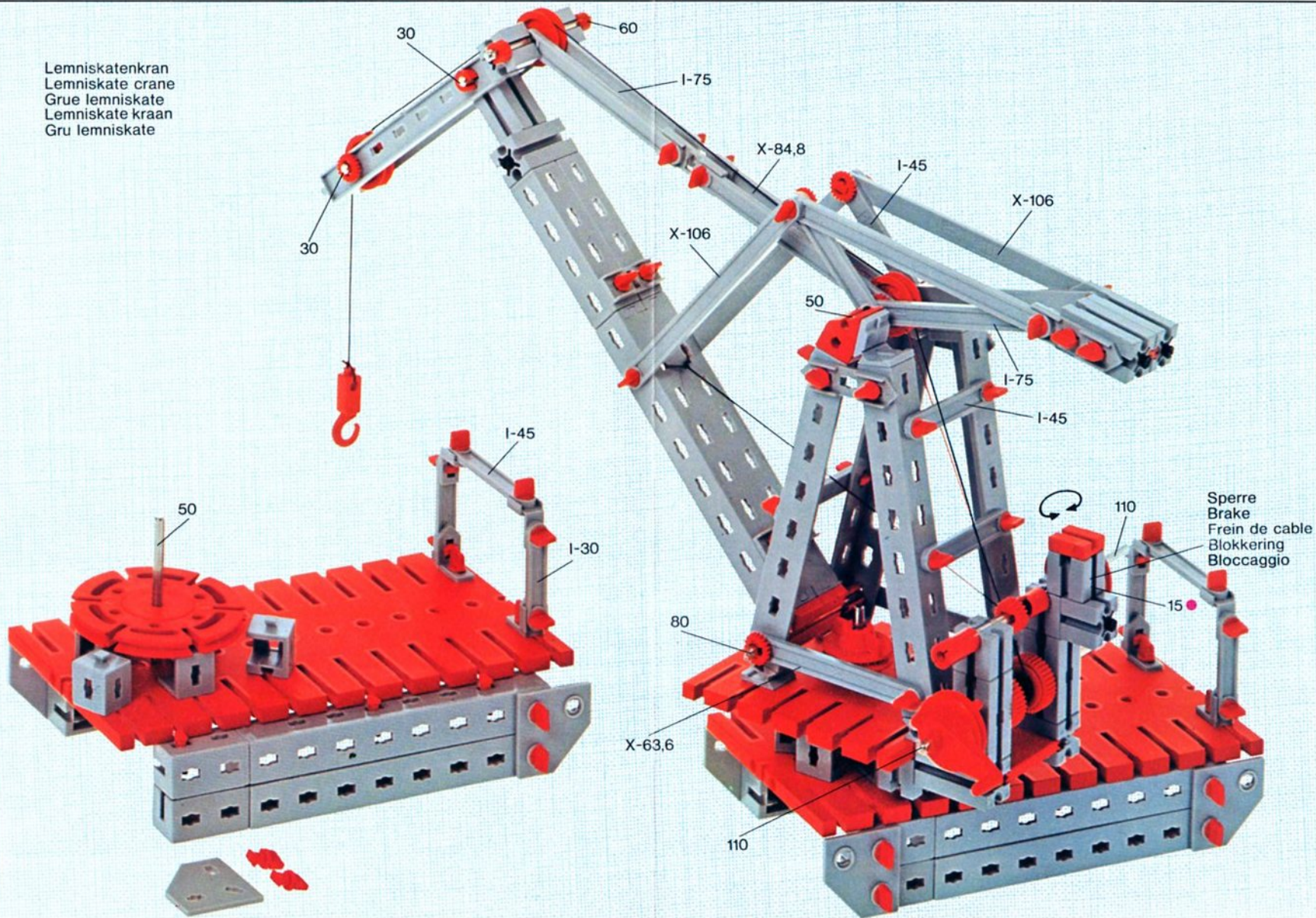









Lemniskatenkran  
 Lemniskate crane  
 Grue lemniskate  
 Lemniskate kraan  
 Gru lemniskate





Stückliste · part list nomenclature · elenco dei pezzi onderdelen lijst					
Abbildung	Artikel- Nummer	50 S/1 Stück	Benennung	Zusatz- kasten	
	4 36300 1	4	Winkelträger 15 · angle girder 15 · cornière de 15 · trave angolare 15 · hoekdraagsteun 15	ft051	2
	4 36301 1	4	Winkelträger 30 · angle girder 30 · cornière de 30 · trave angolare 30 · hoekdraagsteun 30	ft051	4
	4 36302 1	4	Winkelträger 60 · angle girder 60 · cornière de 60 · trave angolare 60 · hoekdraagsteun 60	ft051	2
	4 36305 1	8	Flachträger 120 · flat girder 120 · étrier de 120 · trave piatta 120 · vlakke draagsteun 120	ft057	3
	4 36307 1	8	Flachstück 120 · flat strut 120 · element plat de 120 · pezzo piatto 120 · vlakke steun 120	ft057	5
	4 36321 1	2	Platte 180×90 · plate 180×90 · plaque de 180×90 · piastra 180×90 · plaat 180×90	ft054	2
	4 36326 1	2	Lasche 15 · fish-plate 15 · éclisse de 15 · coprigiunto 15 · rechtverbindungsstuk 15	ft053	4
	4 36327 1	4	Lasche 21,3 · fish-plate 21,3 · éclisse de 21,3 · coprigiunto 21,3 · rechtverbindungsstuk 21,3	ft053	4
	4 36325 1	4	Eckknotenplatte · corner connector plate · gousset d'angle · piastra nodale angolare · hoekknoopplaat	ft053	2
	4 36322 1	2	Kreuzknotenplatte · nodal connector plate · gousset à croisillon · piastra nodale a croce · kruisknoopplaat	ft053	2
	4 35797 1	4	Doppelknotenplatte · dual connector plate · gousset d'angle double · piastra nodale doppia · dubbele knoopplaat	ft053	2
	3 36518 1	1	Kassette · case · coffret · cassetta · cassette	ft027	3
	4 36329 1	4	Scharnier · hinge charnière · cerniera · scharnier	ft053	8



