

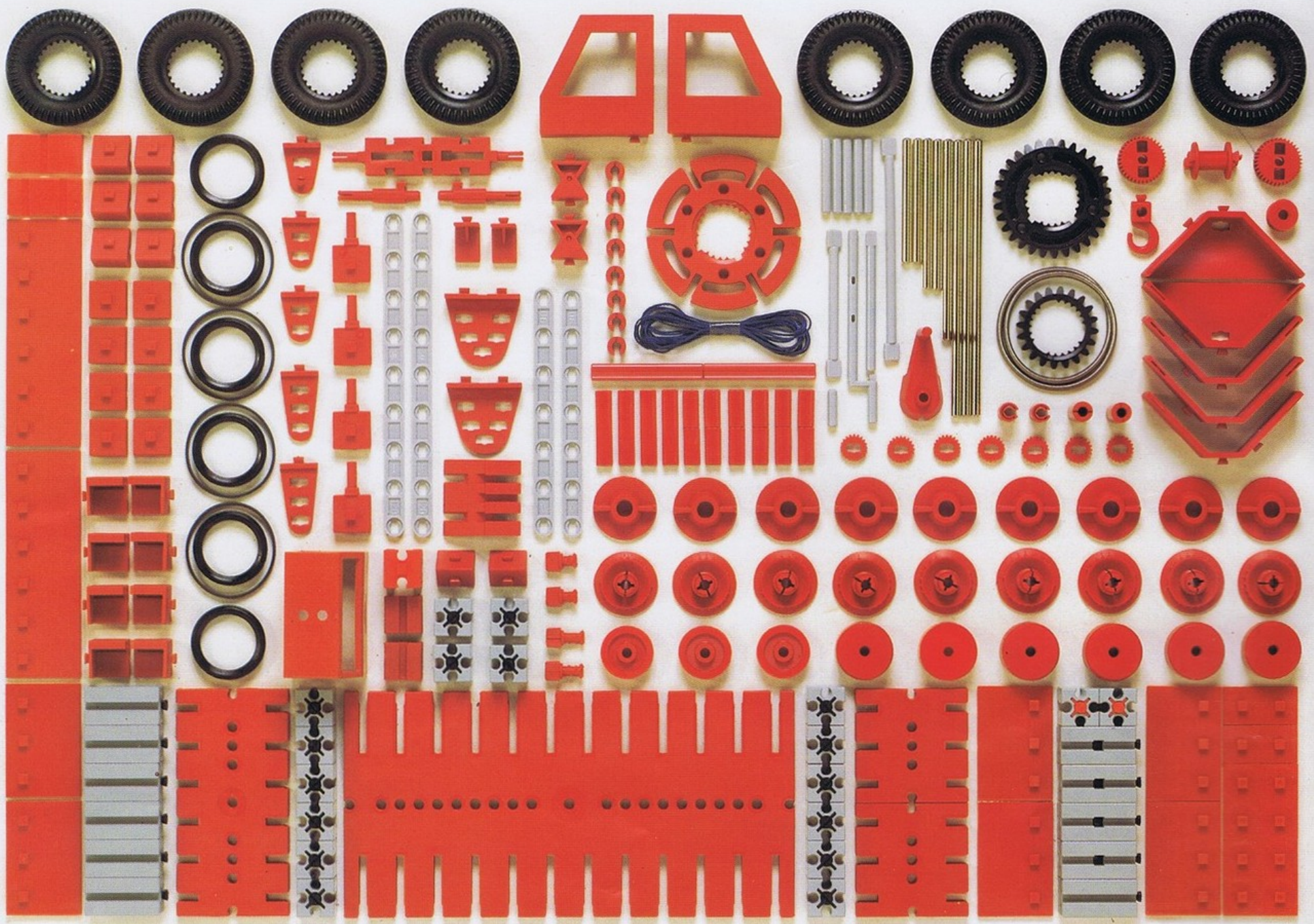

fischertechnik[®]



Statik



Start 100

Start 200



fischertechnik beginnt mit Start 100 (100 verschiedene Modelle) oder Start 200 (200 verschiedene Modelle).

Start 100 wird erweitert durch Start 100/1 (50/2) auf Start 200.

Start 200 wird erweitert durch Start 200/1 (50/3). Es ergeben sich viele neue interessante Baumöglichkeiten.



fischertechnik begins with either "Start 100" (100 different models) or "Start 200" (200 different models).

"Start 100" may be converted into "Start 200" by using "Start 100/1" (50/2).

"Start 200" may be converted using "Start 200/1" (50/3). Many new and interesting construction ideas result.



fischertechnik débute avec «Start 100» (100 modèles différents) ou «Start 200» (200 modèles différents).

«Start 100» peut se compléter en version «Start 200» moyennant «Start 100/1» (50/2).

«Start 200» peut se compléter moyennant «Start 200/1» (50/3). Il en résulte de nombreuses nouvelles possibilités de construction particulièrement intéressantes.



fischertechnik begint met „Start 100” (100 verschillende modellen) of „Start 200” (200 verschillende modellen).

„Start 100” kan door „Start 100/1” (50/2) uitgebreid worden.

„Start 200” kan door „Start 200/1” (50/3) uitgebreid worden. Daardoor ontstaan talloze nieuwe bouw mogelijkheden.

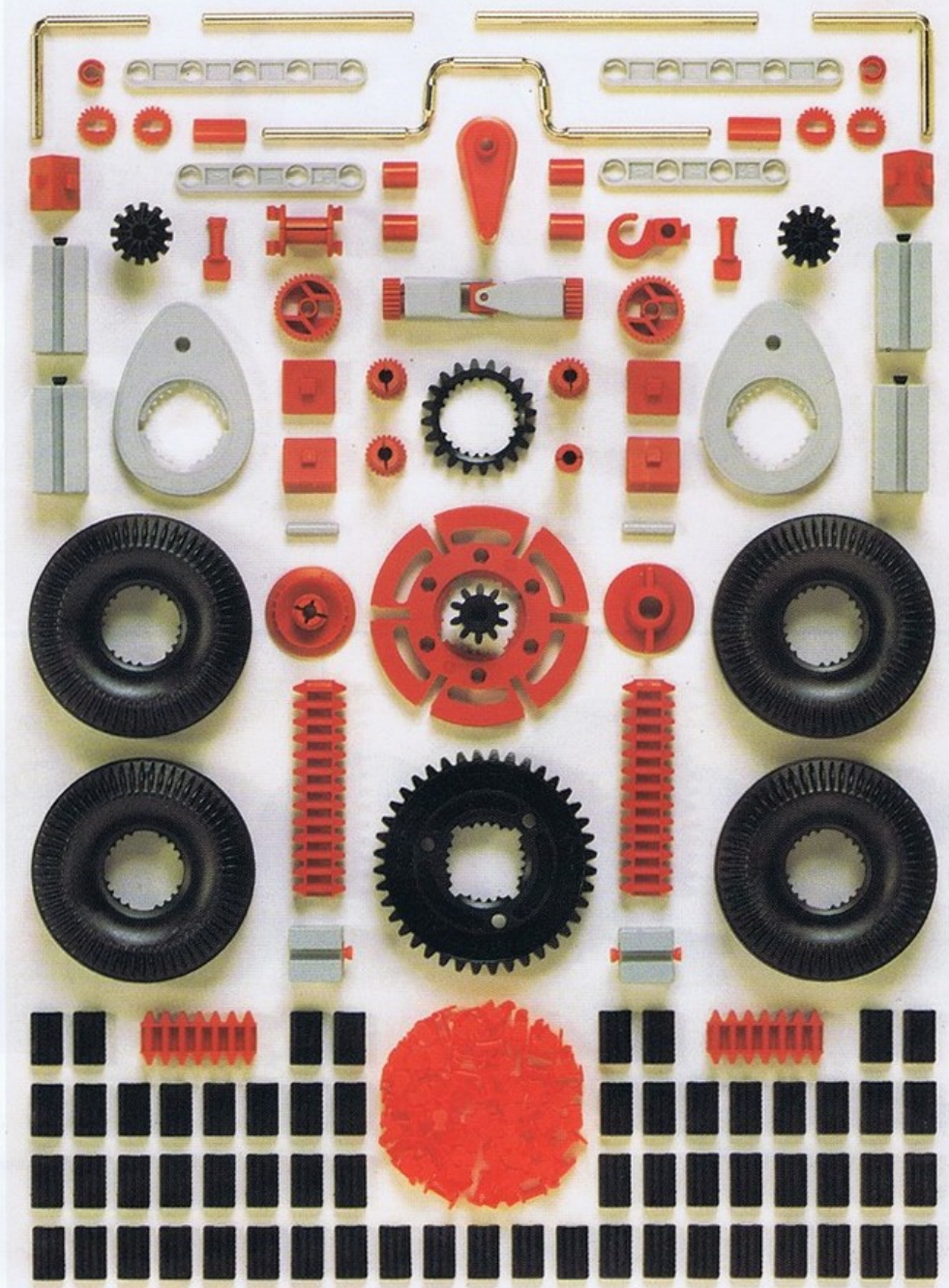
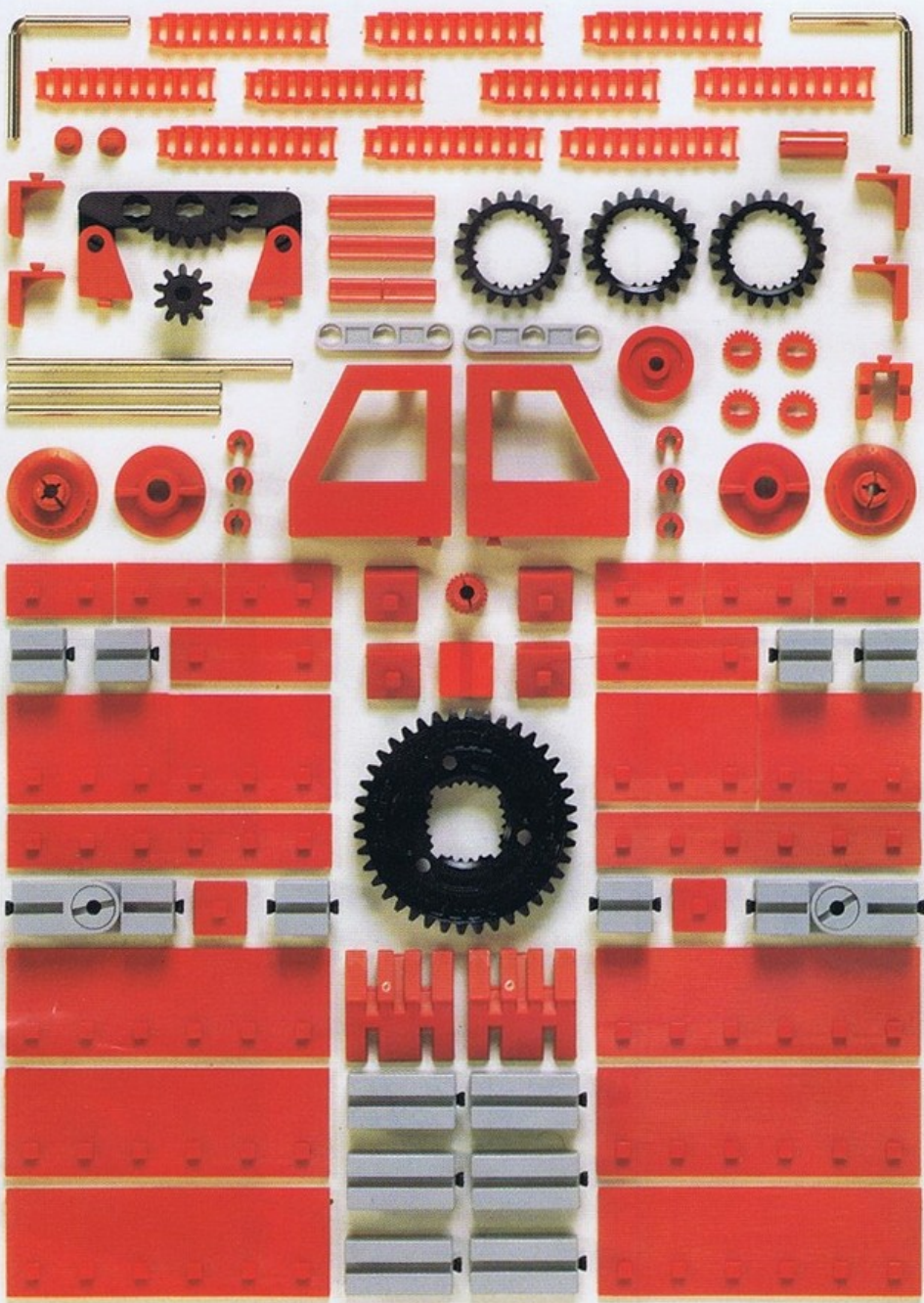

Start 100/1



fischertechnik comienza con «Start 100» (100 modelos diferentes) o con «Start 200» (200 modelos diferentes).

«Start 100» puede ser ampliado por «Start 100/1» (50/2) a «Start 200».

«Start 200» puede ser ampliado por «Start 200/1» (50/3). La caja ofrece muchas nuevas posibilidades de construcción muy interesantes.



Il gioco fischertechnik ha inizio con: «Start 100» (100 diversi modelli) oppure «Start 200» (200 diversi modelli).

Aggiungendo allo «Start 100» la cassetta di ampliamento «Start 100/1» (50/2) si compone lo «Start 200».

Lo «Start 200» può essere ulteriormente perfezionato con la cassetta «Start 200/1» (50/3) per avere molte altre possibilità di costruzione.

Start 200/1



fischertechnik börjar med »Start 100« (100 olika modeller) eller »Start 200« (200 olika modeller).

»Start 100« bygges ut med »Start 100/1« (50/2) till »Start 200«.

»Start 200« bygges ut med »Start 200/1« (50/3). Det ger många nya intressanta byggmöjligheter.

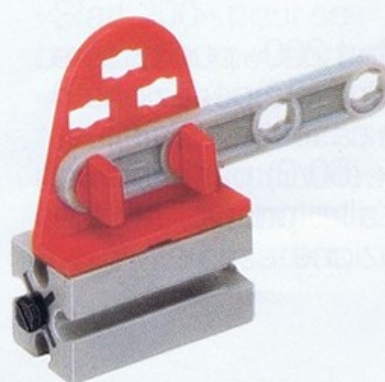
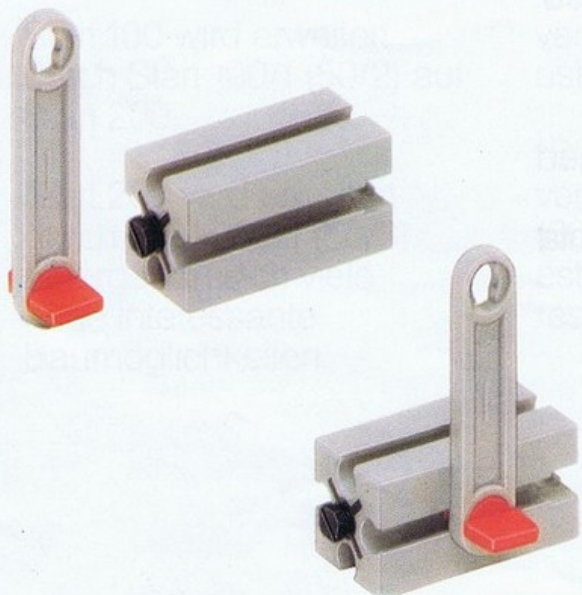
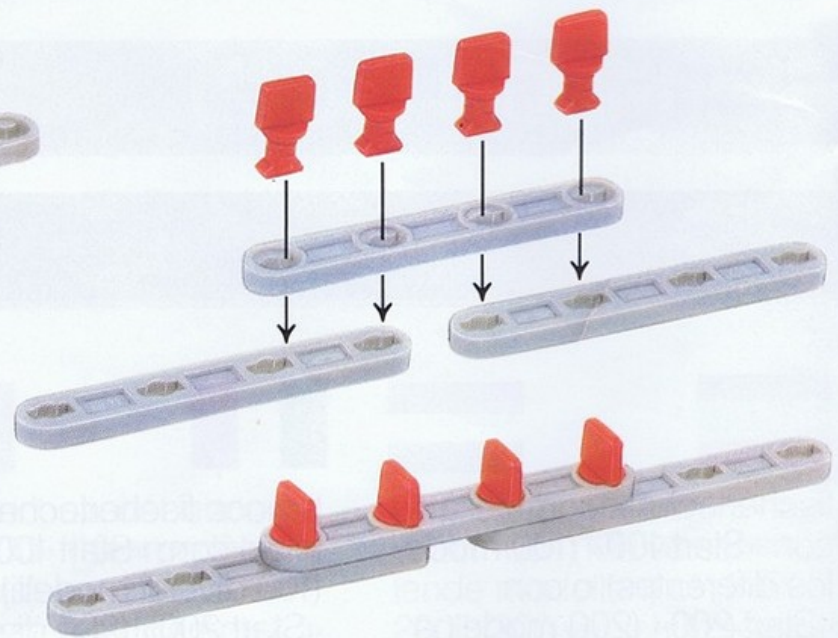
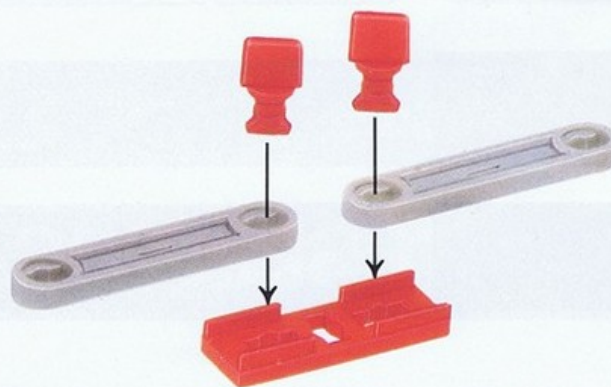
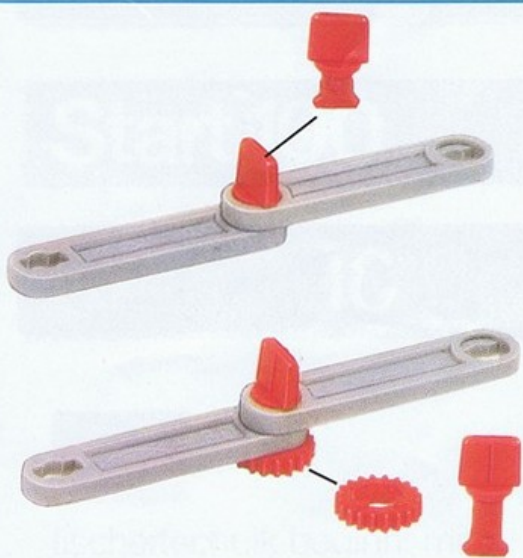
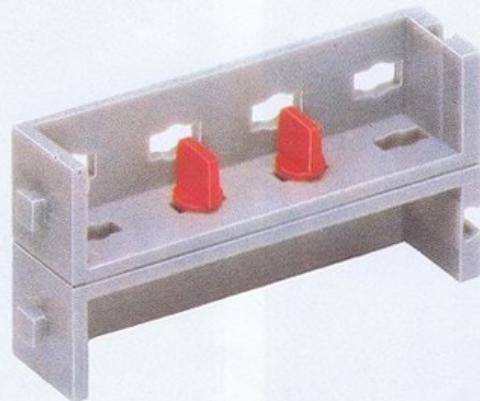
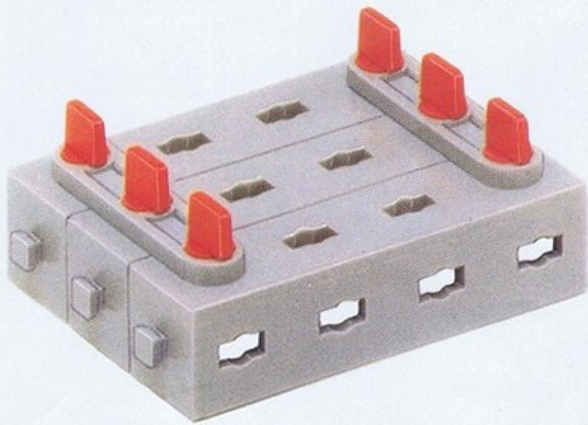
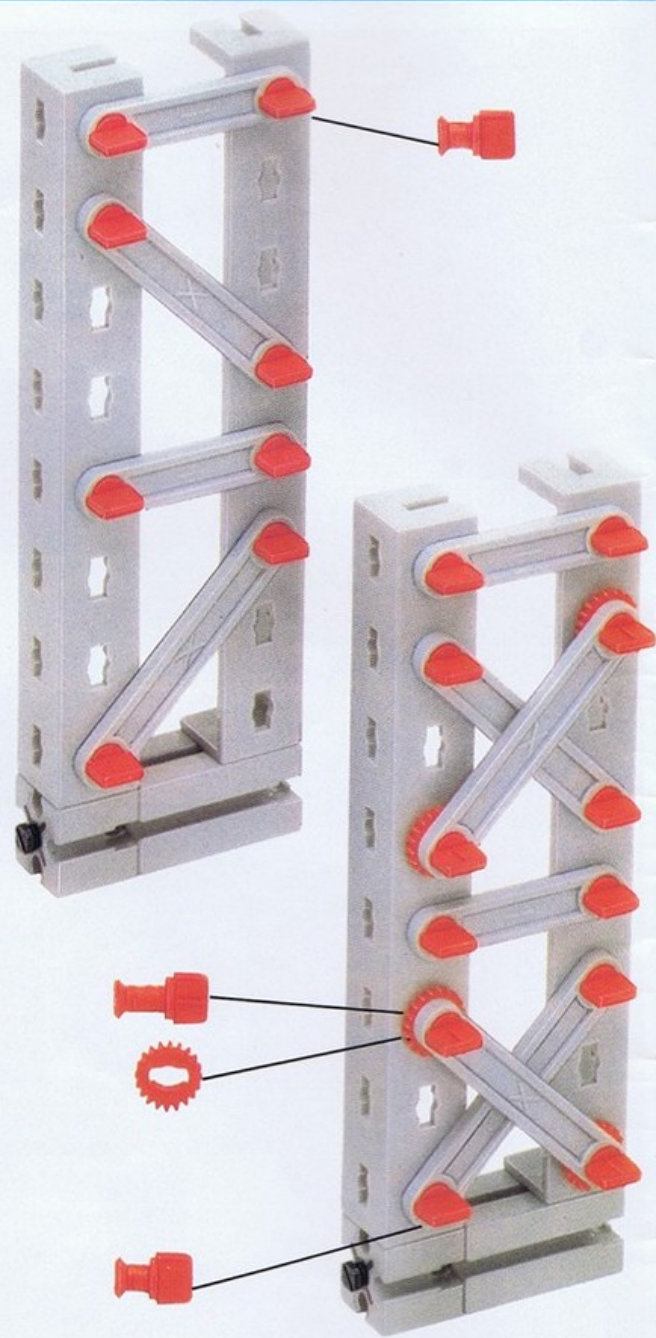
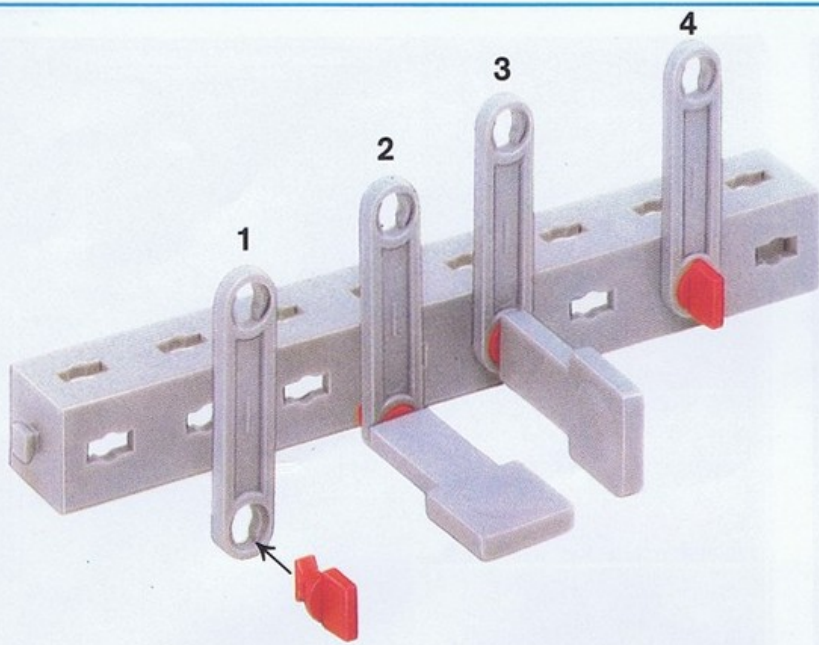

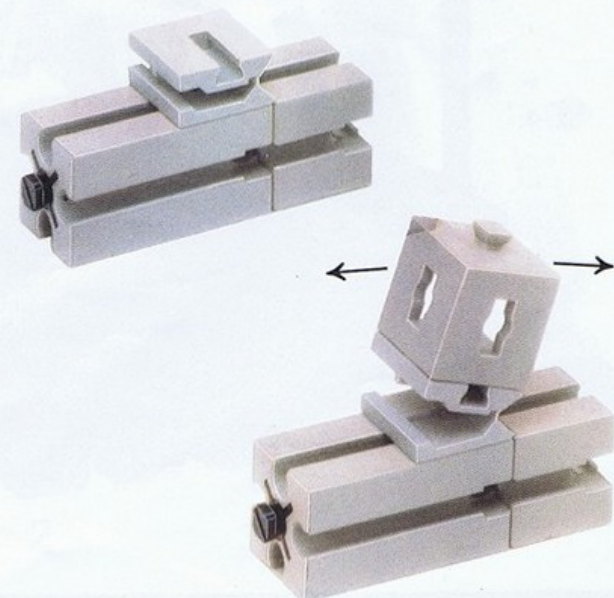
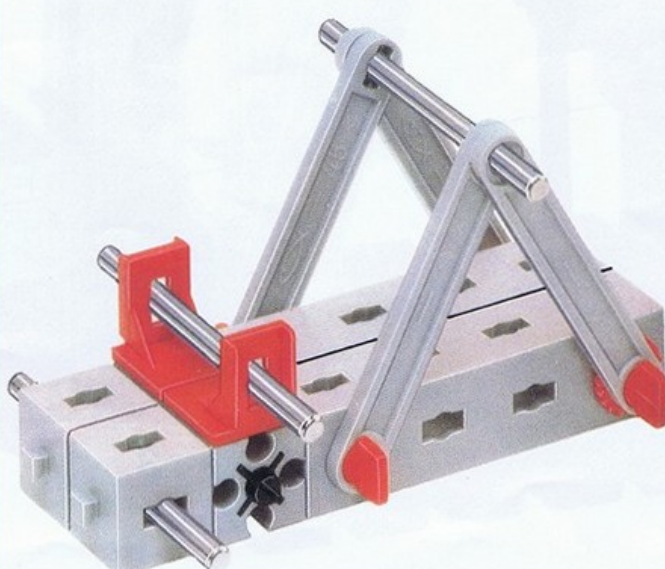
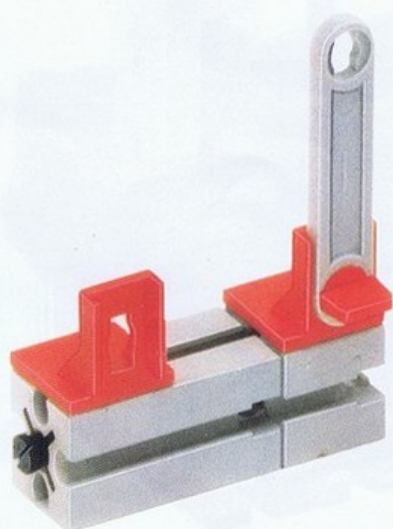
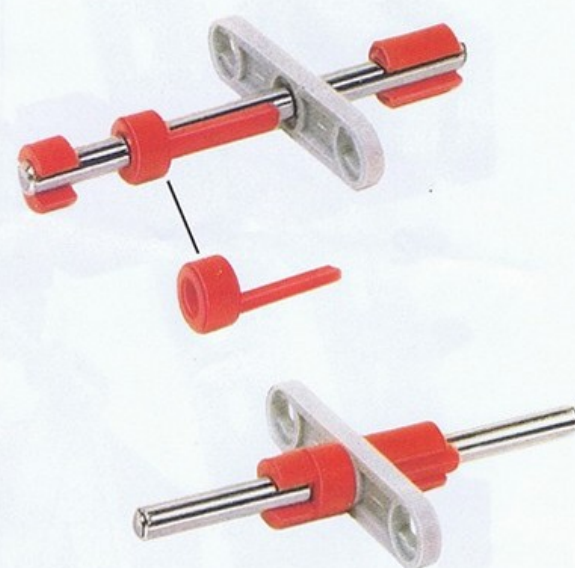
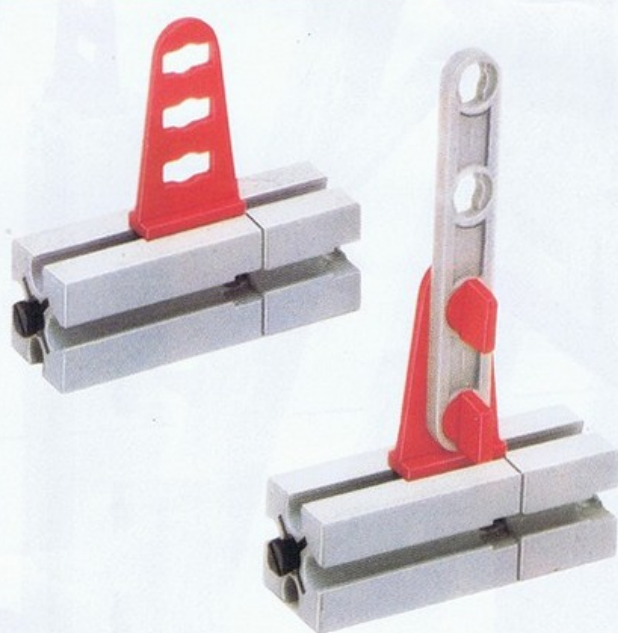
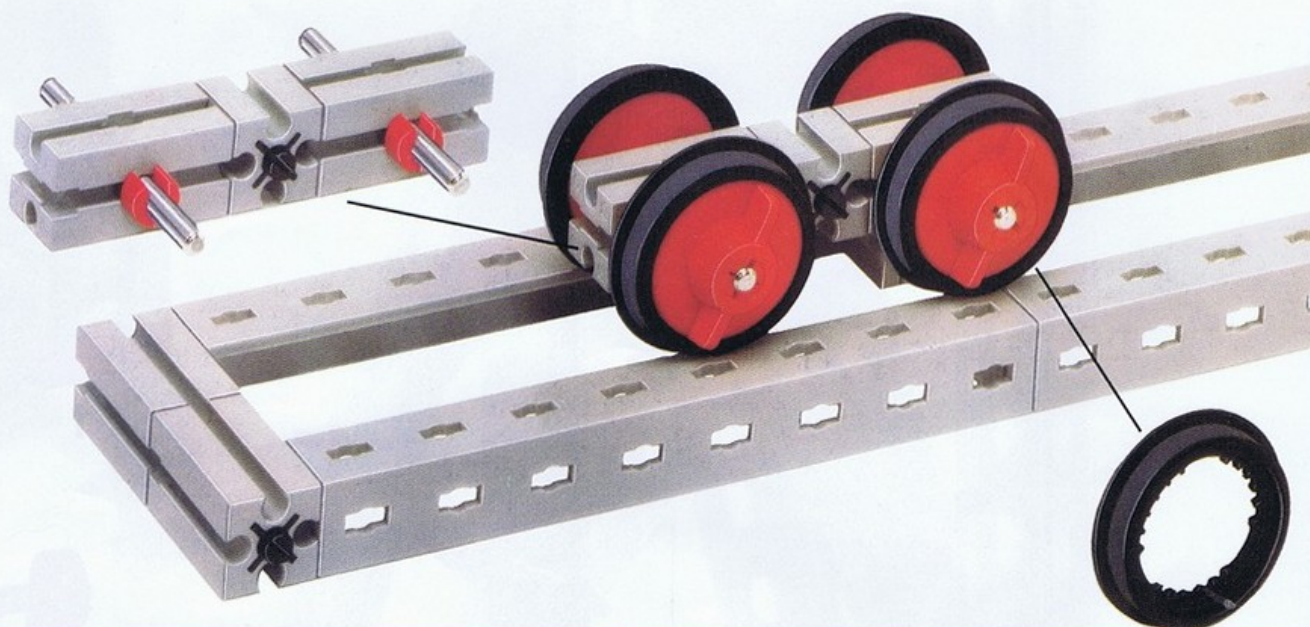
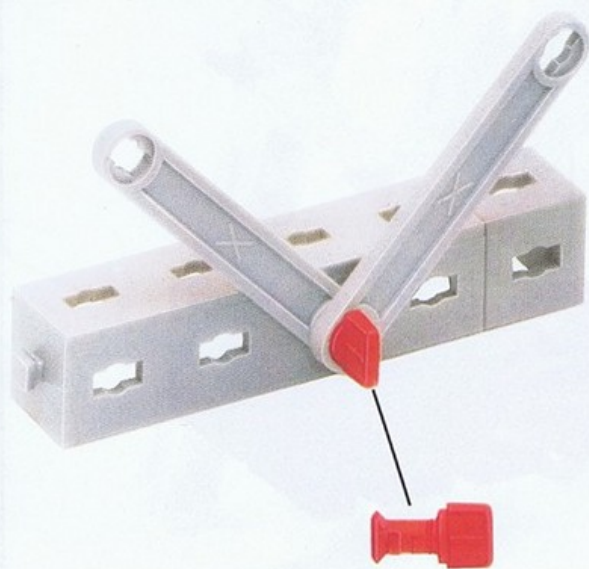

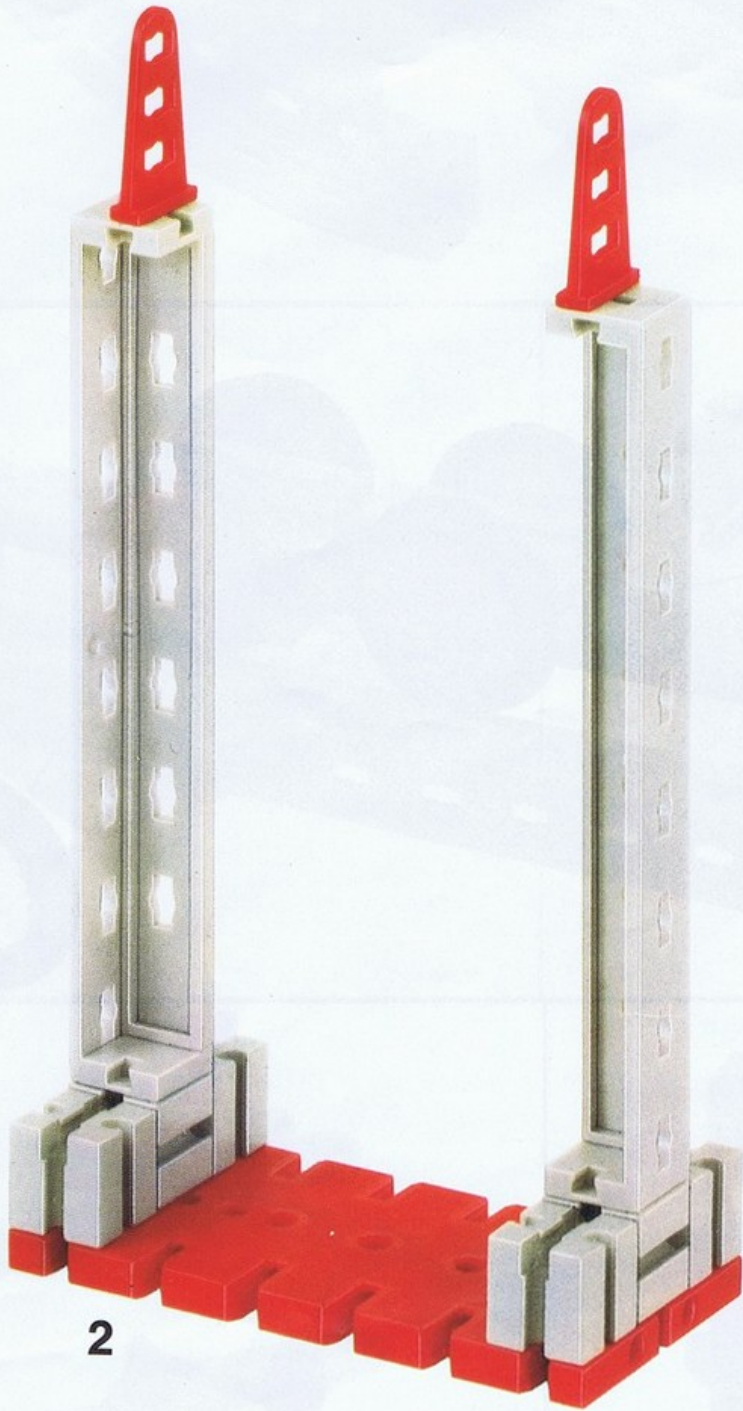

2

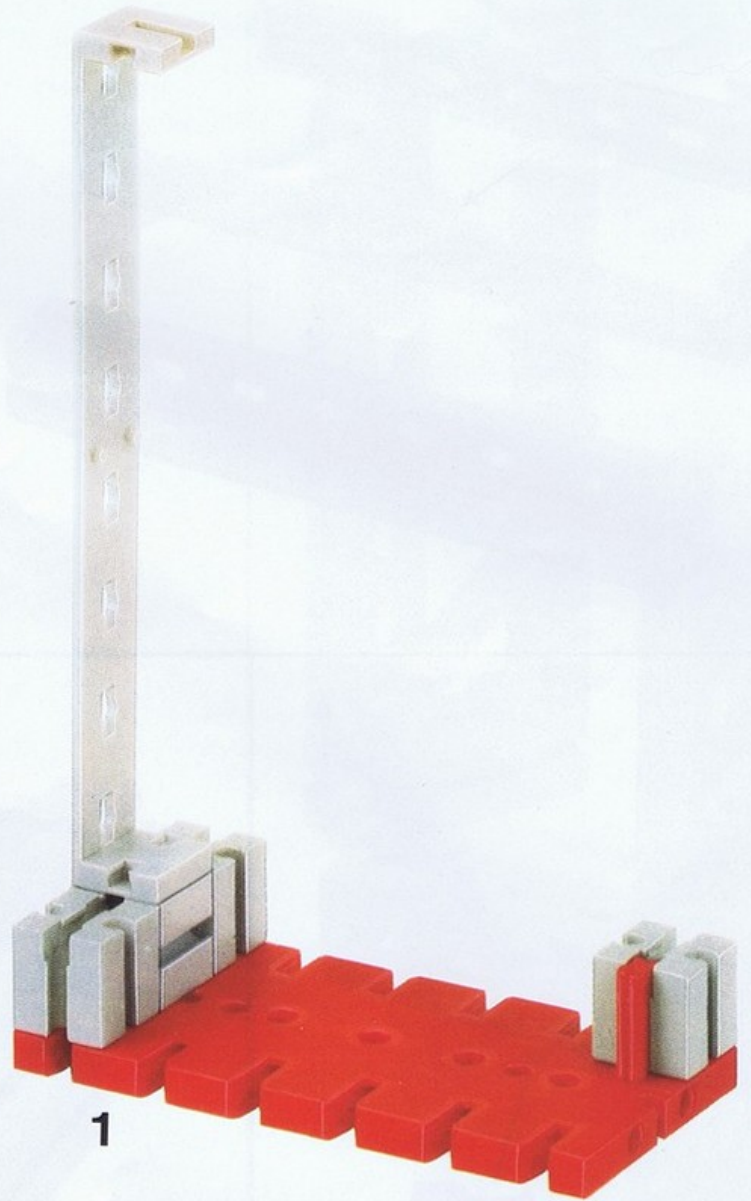

1

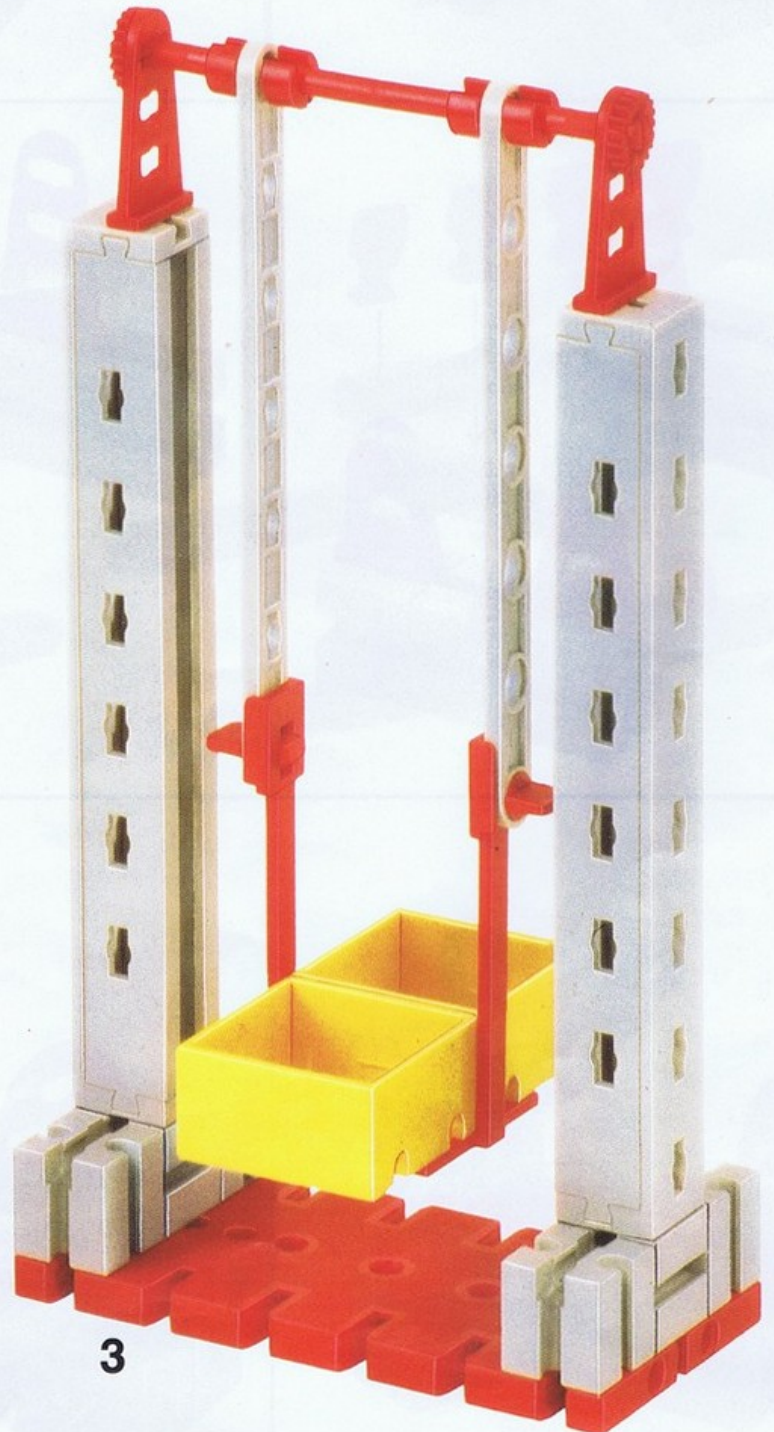
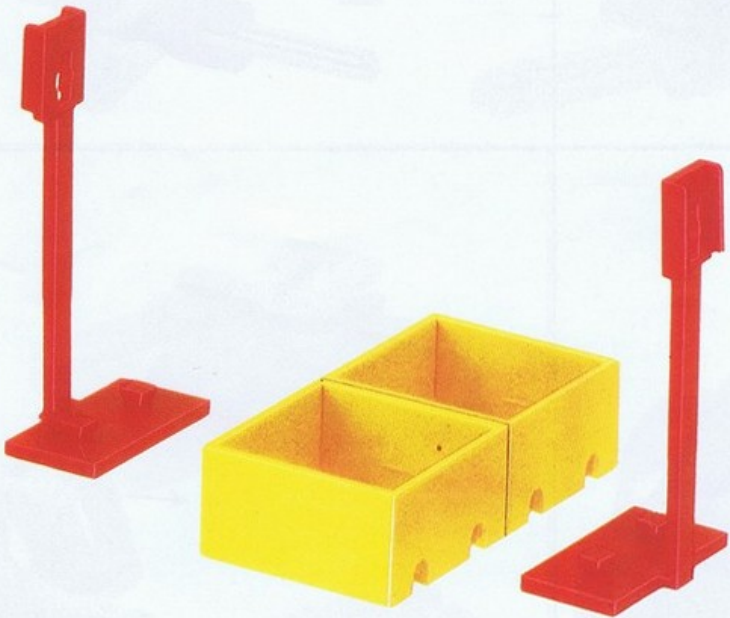

3



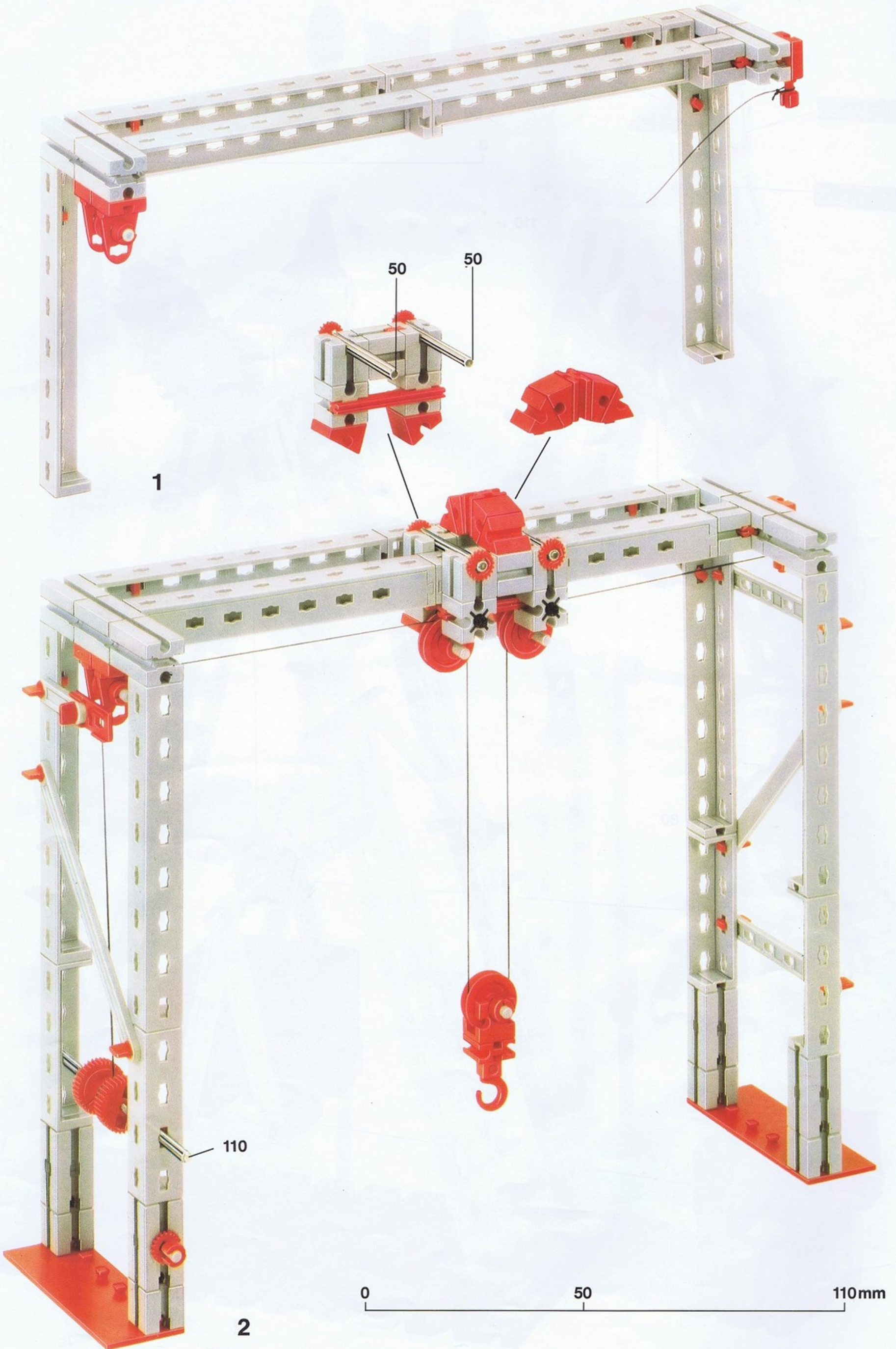

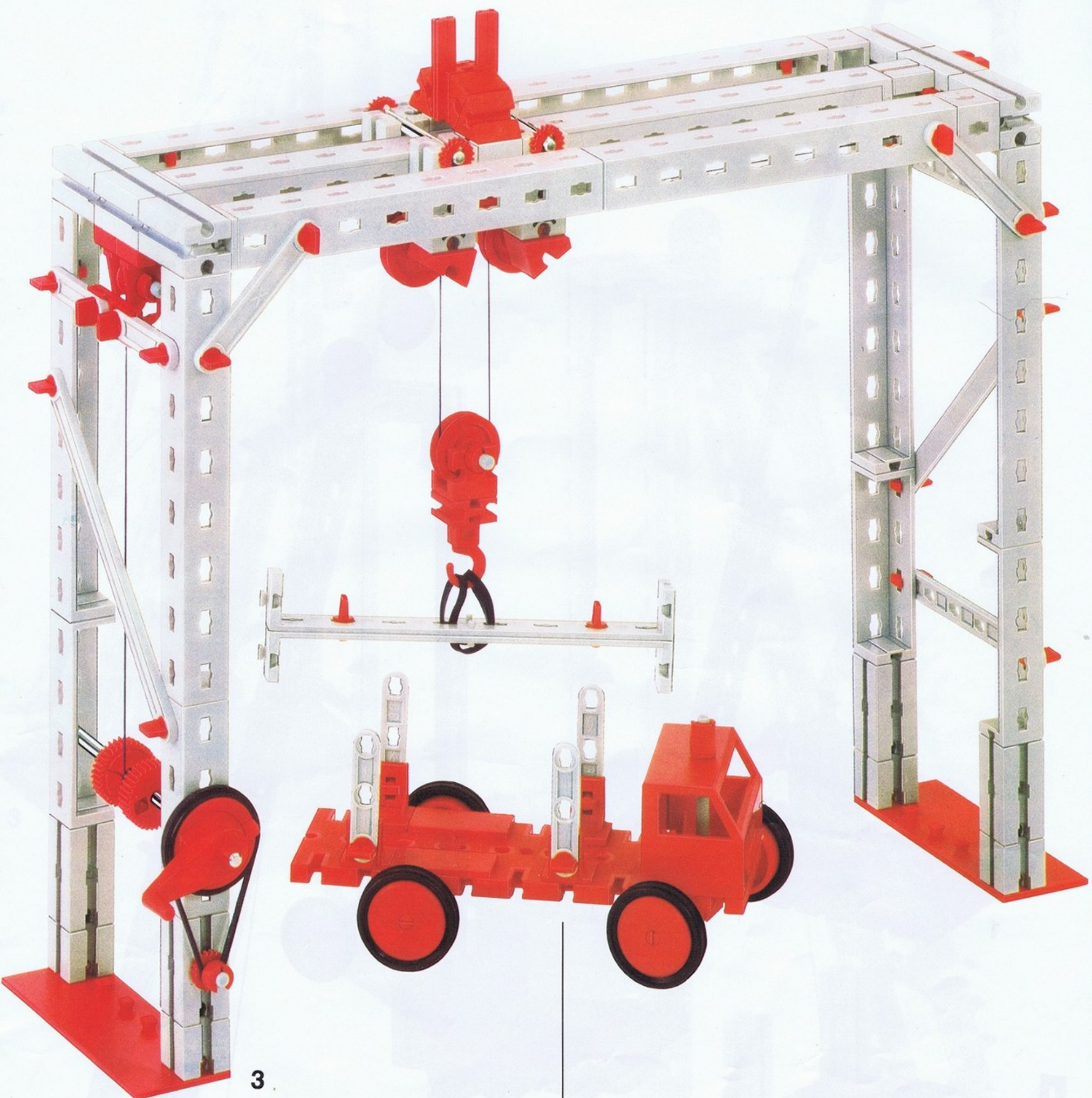

3

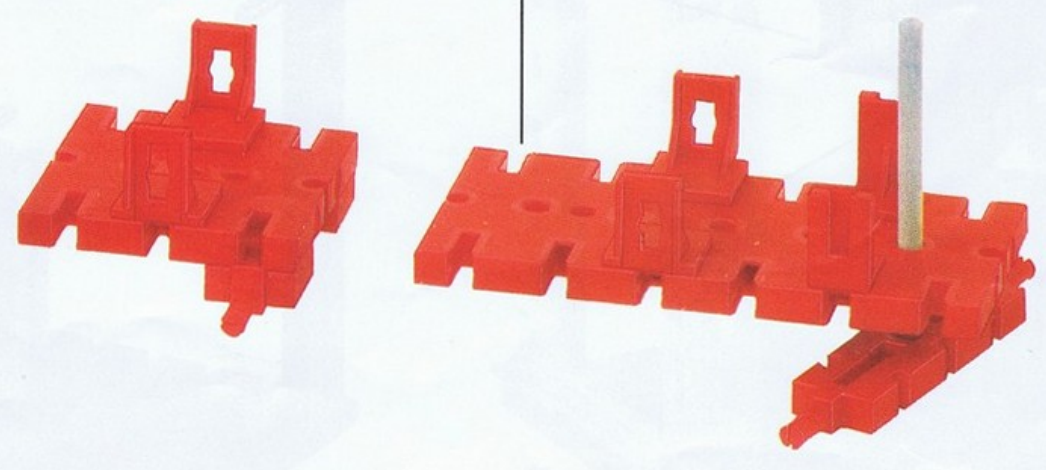

0 80 110mm







0 50 60 mm

50

1

60

2



3

0 60 110mm





3

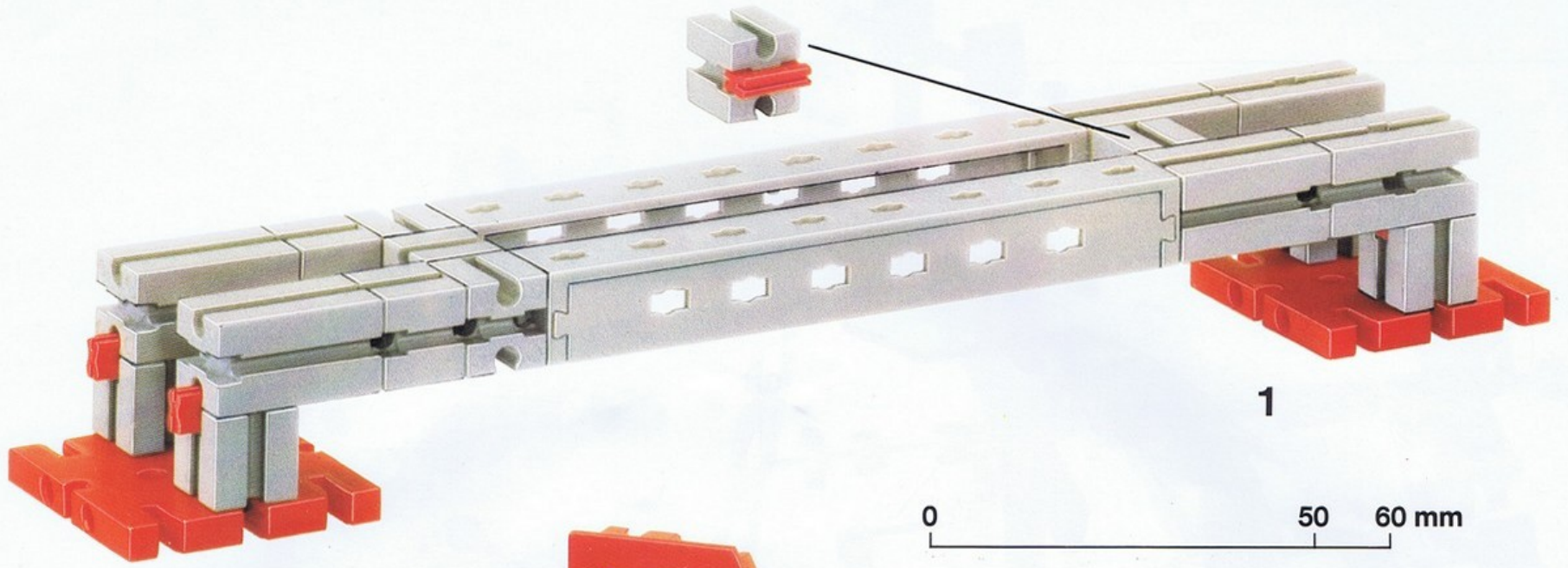

1

0 50 60 mm

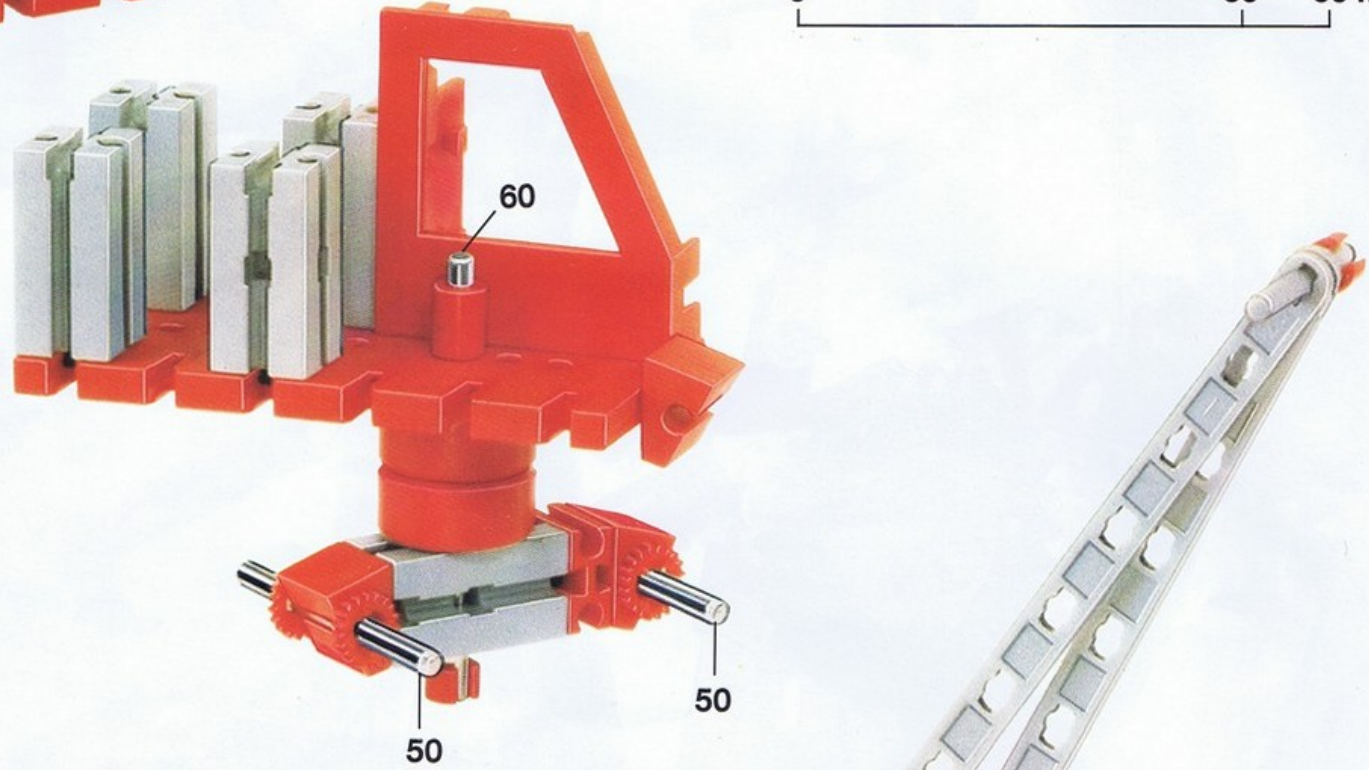

60

50

50

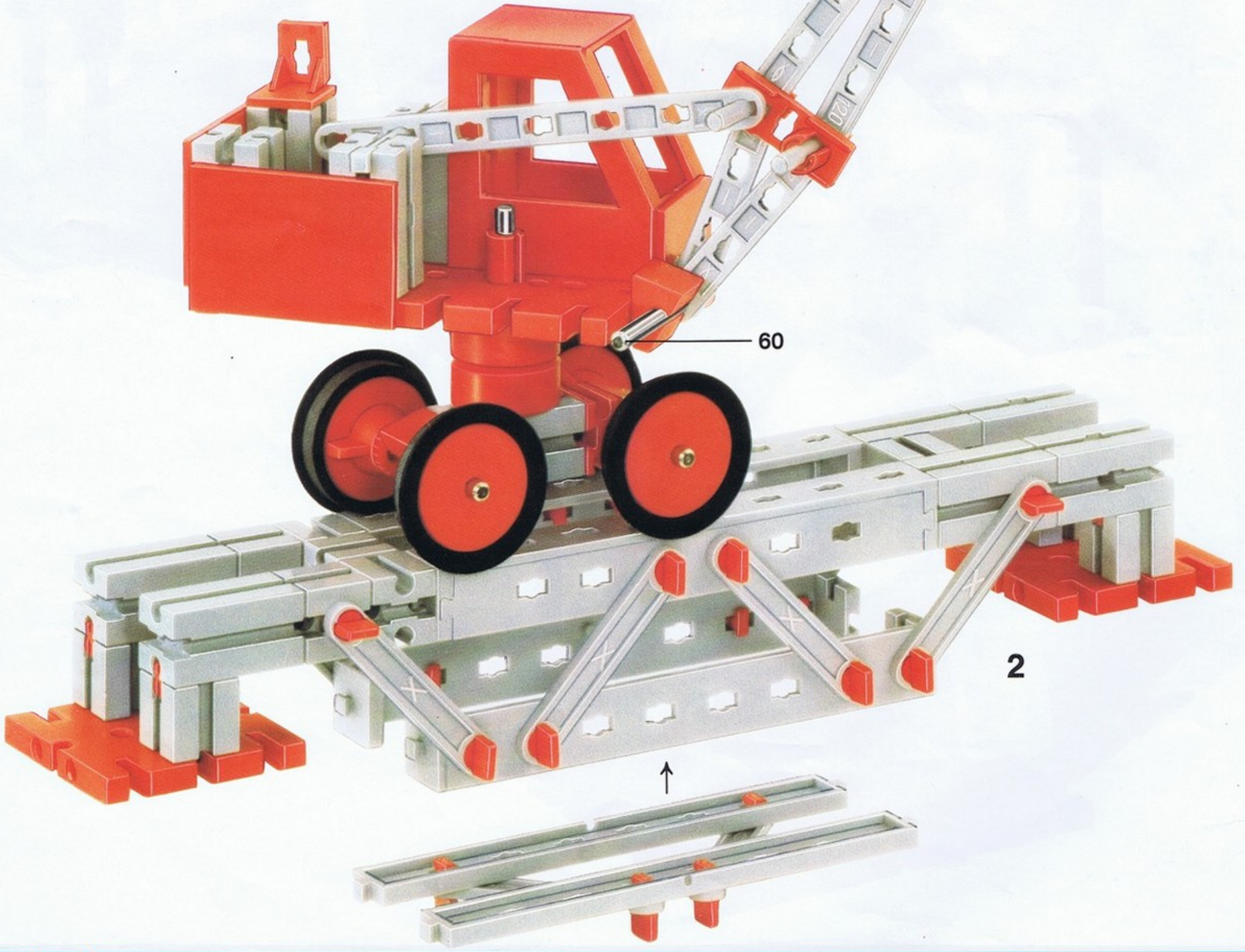

60

2



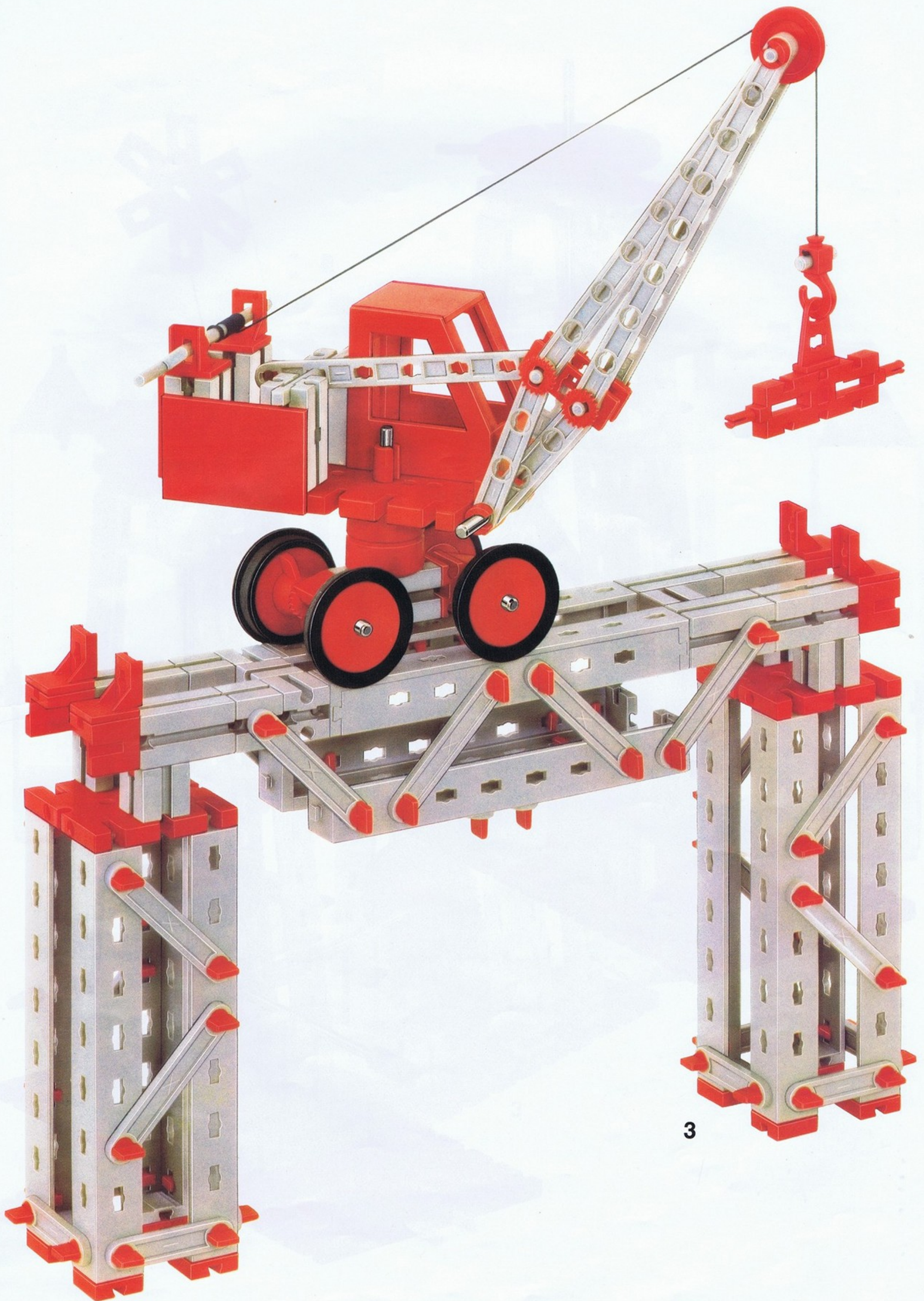

3





3

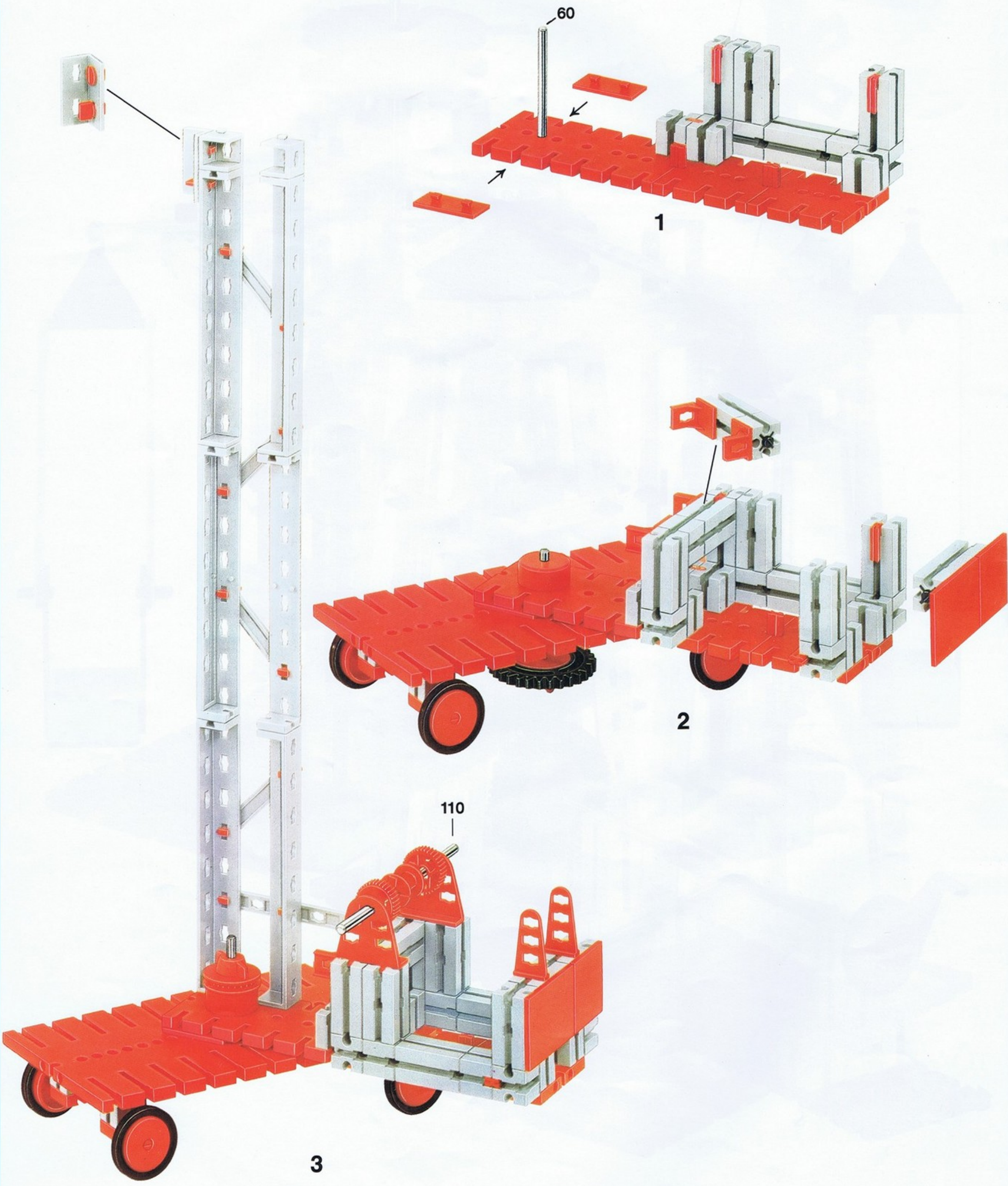

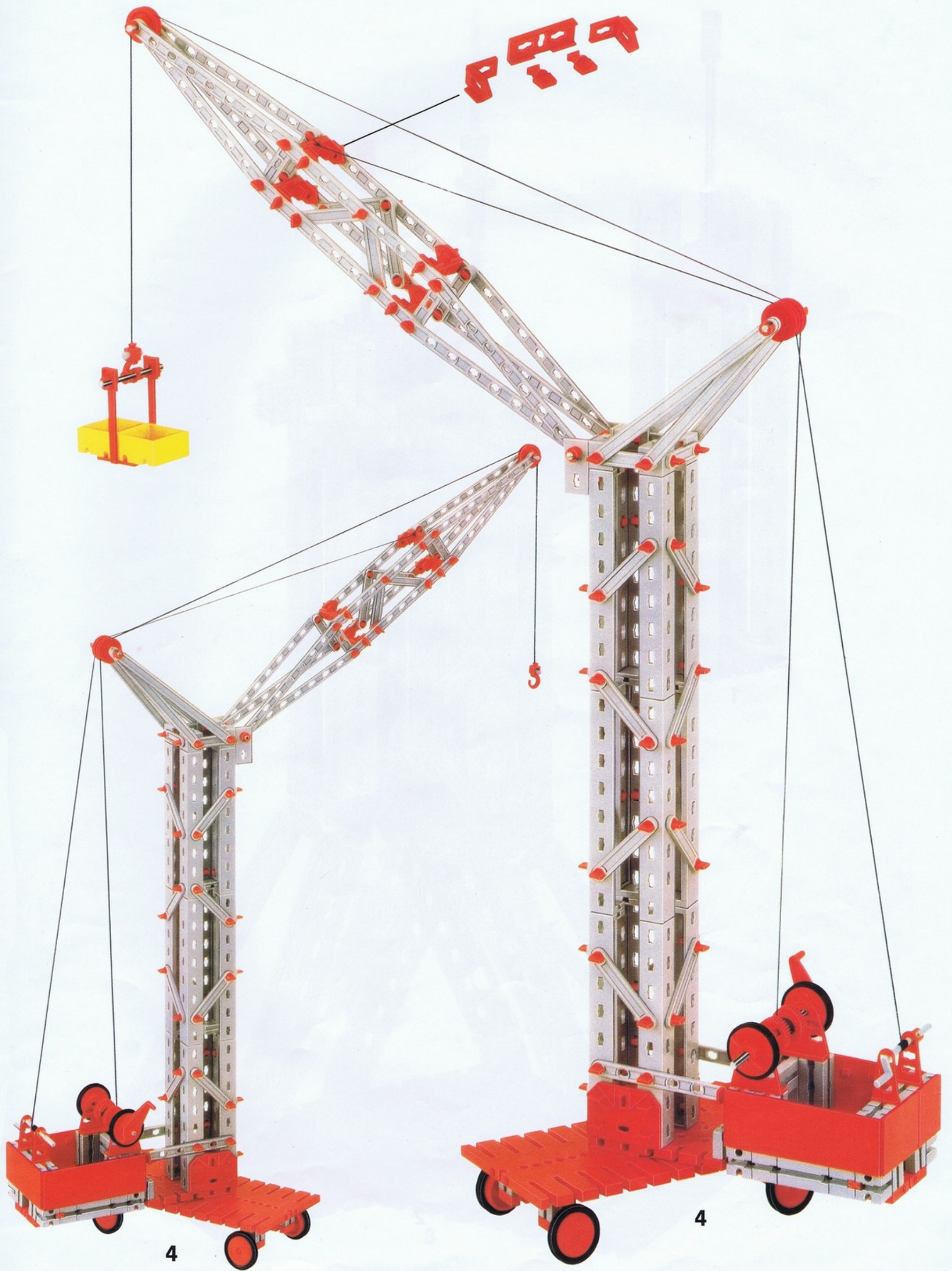

4

4

0 80 110mm

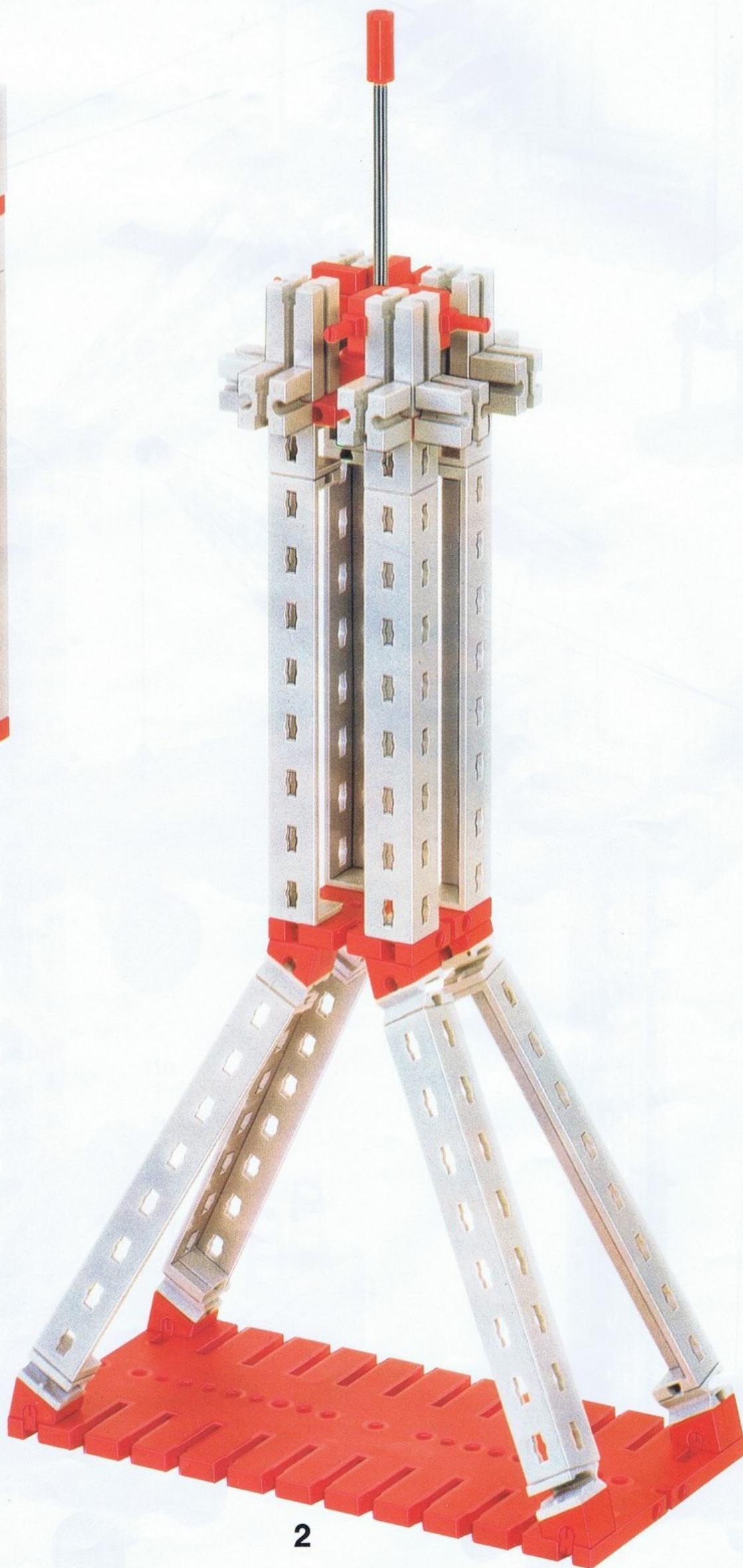

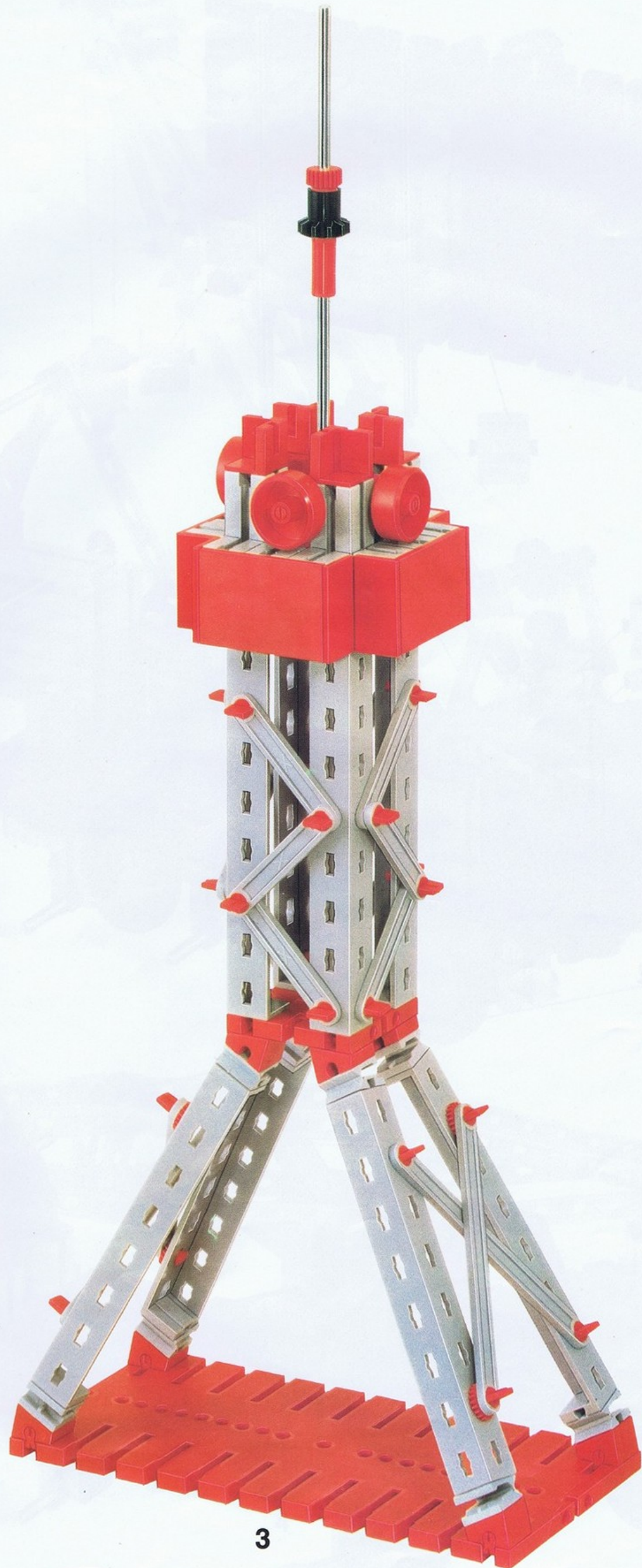

3

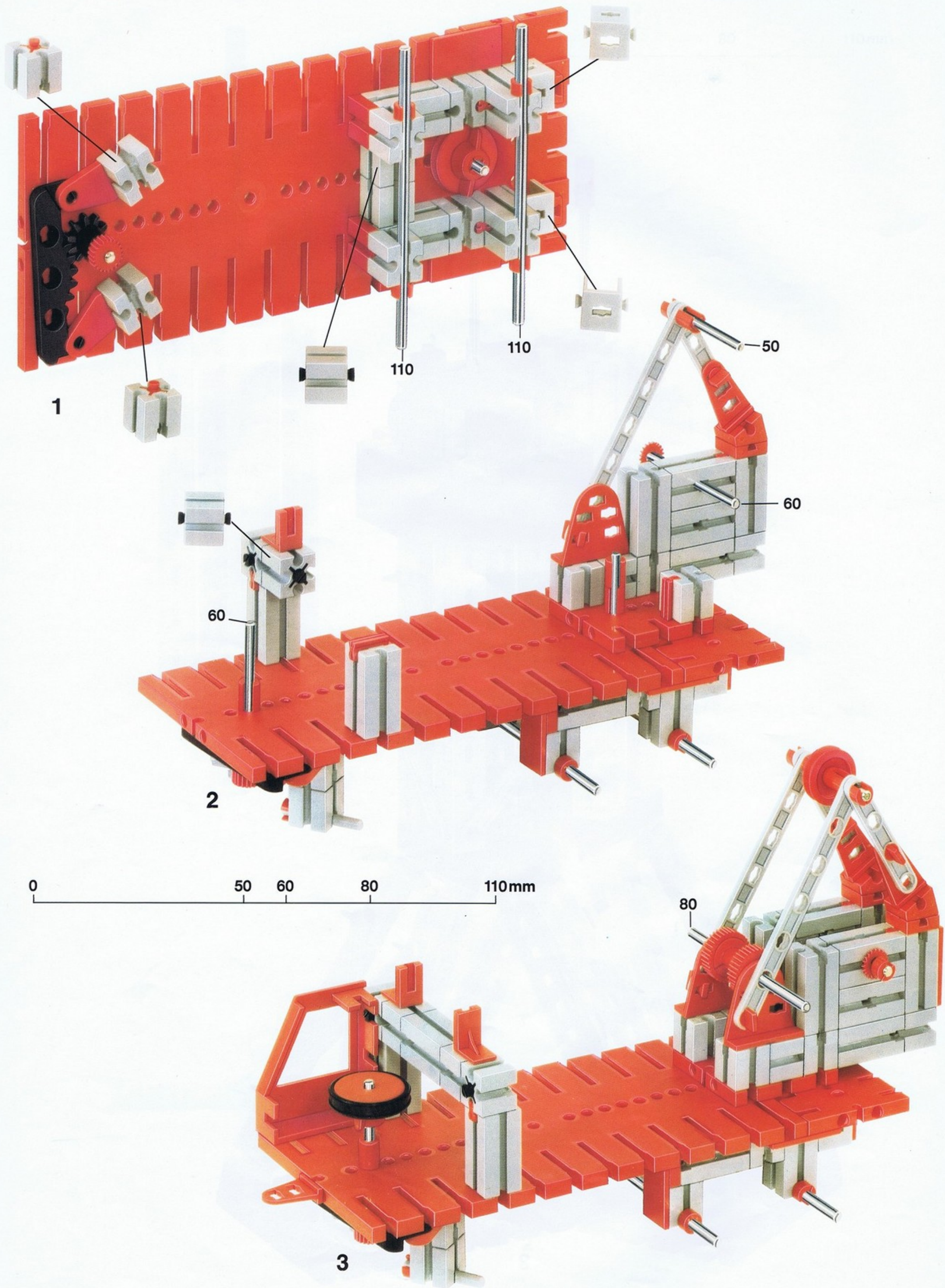

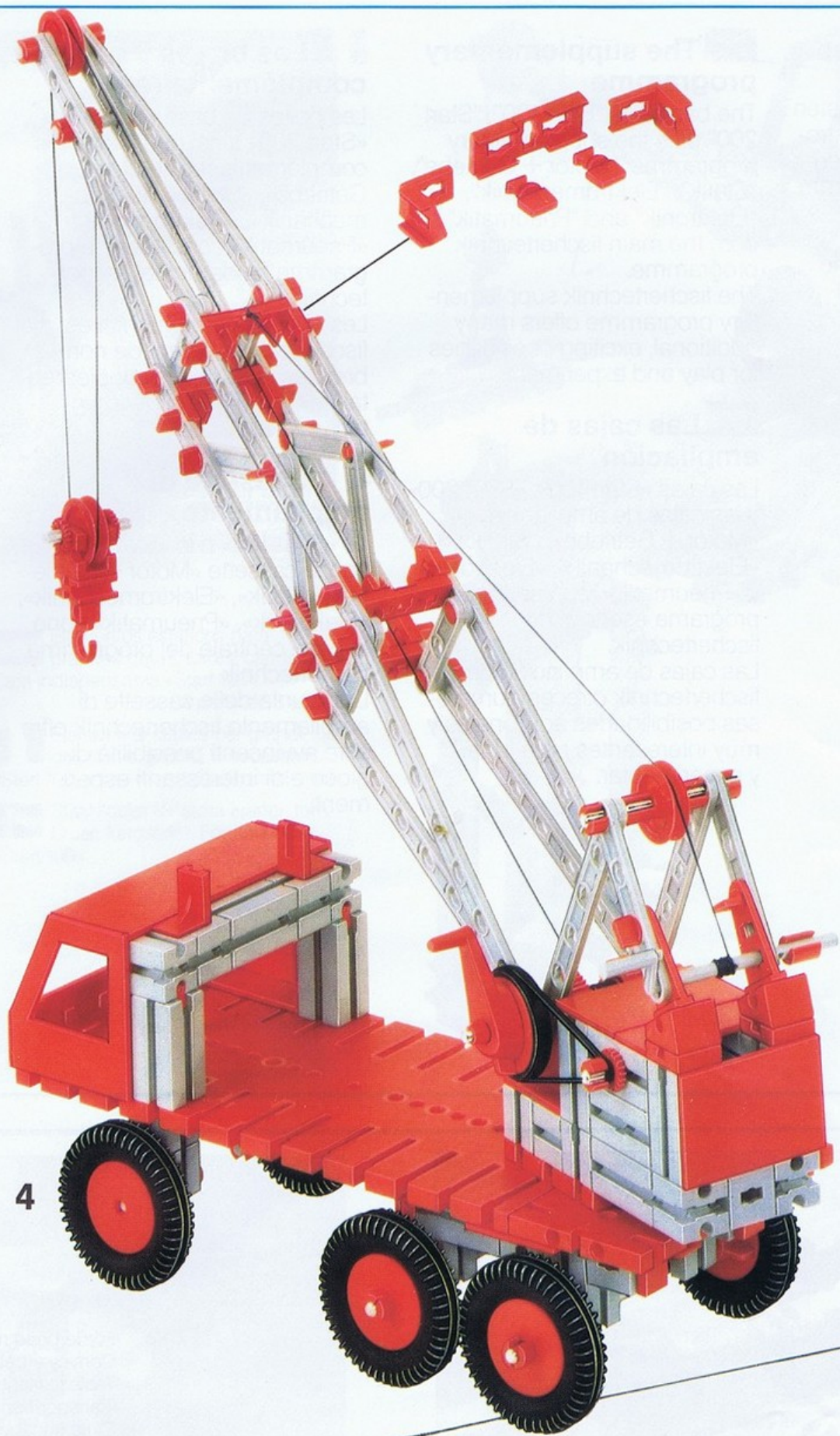

Die Ausbau-Kästen

Die Baukästen Start 100, Start 200 und die Ausbau-Kästen Motor + Getriebe, Statik, Elektromechanik, Elektronik und Pneumatik bilden das Kernprogramm von fischertechnik. Die fischertechnik Ausbau-Kästen bieten viele zusätzliche spannende Spiel- und Experimentiermöglichkeiten.

The supplementary programme

The basic kits "Start 100", "Start 200" plus the supplementary programme: "Motor + Getriebe", "Statik", "Elektromechanik", "Elektronik" and "Pneumatik", from the main fischertechnik programme. The fischertechnik supplementary programme offers many additional, exciting possibilities for play and experiment.

Las cajas de ampliación

Las cajas «Start 100», «Start 200» y las cajas de ampliación «Motor + Getriebe», «Statik», «Elektromechanik», «Elektronik» y «Pneumatik» representan el programa esencial de fischertechnik. Las cajas de ampliación de fischertechnik ofrecen numerosas posibilidades adicionales y muy interesantes para jugar y experimentar.

Les boîtes complémentaires

Les boîtes de base «Start 100», «Start 200» ainsi que les boîtes complémentaires «Motor + Getriebe», «Statik», «Elektromechanik», «Elektronik» et «Pneumatik» constituent le programme fondamental fischertechnik. Les boîtes complémentaires fischertechnik offrent de nombreuses possibilités supplémentaires de jeu et d'expérimentation.

Cassette di ampliamento

Lo «Start 100» e lo «Start 200» con le cassette «Motor + Getriebe», «Statik», «Elektromechanik», «Elektronik», «Pneumatik» sono la base centrale del programma fischertechnik. L'aggiunta delle cassette di ampliamento fischertechnik offre altre avvincenti possibilità di gioco e di interessanti esperimenti.

De uitbreidingsdozen

De bouwdozen „Start 100“, „Start 200“ en de uitbreidingsdozen „Motor + Getriebe“, „Statik“, „Elektromechanik“, „Elektronik“ en „Pneumatik“ vormen het basisprogramma van fischertechnik. De fischertechnik uitbreidingsdozen bieden vele extra mogelijkheden om te spelen en te experimenteren.

Utbyggnadslådorna

Bygglådan »Start 100«, »Start 200« och utbyggnadslådorna »Motor + Getriebe«, »Statik«, »Elektromechanik«, »Elektronik« och »Pneumatik« är baslådorna i fischertechnik. fischertechnik utbyggnadslådor erbjuder mängder med ytterligare spännande lek- och experimentmöjligheter.





 Motor und viele Getriebe-Elemente. Voraussetzung Start 100. Ab 6 Jahre.

 Motor and gear parts. Prerequisite: "Start 100". From 6 years.

 Moteur et nombreux éléments d'engrenage. «Start 100» indispensable. A partir de 6 ans.

 Motor en aandrijving elementen. Benodigd: „Start 100“. Voor 6 jaar en ouder.

 Motor y muchos elementos de engranaje. La caja «Start 100» es indispensable. A partir de 6 años.

 Motore e molti ingranaggi. È necessario «Start 100». Da 6 anni in poi.

 Motor och många utväxlingsdelar. Förutsättning »Start 100«. Från 6 år.

Förderband mit Lastwagen
Conveyor belt and lorry
Tapis roulant avec camion
Transportband met vrachtwagen
Cinta transportadora con camión
Nastro trasportatore con camion
Transportband med lastbil

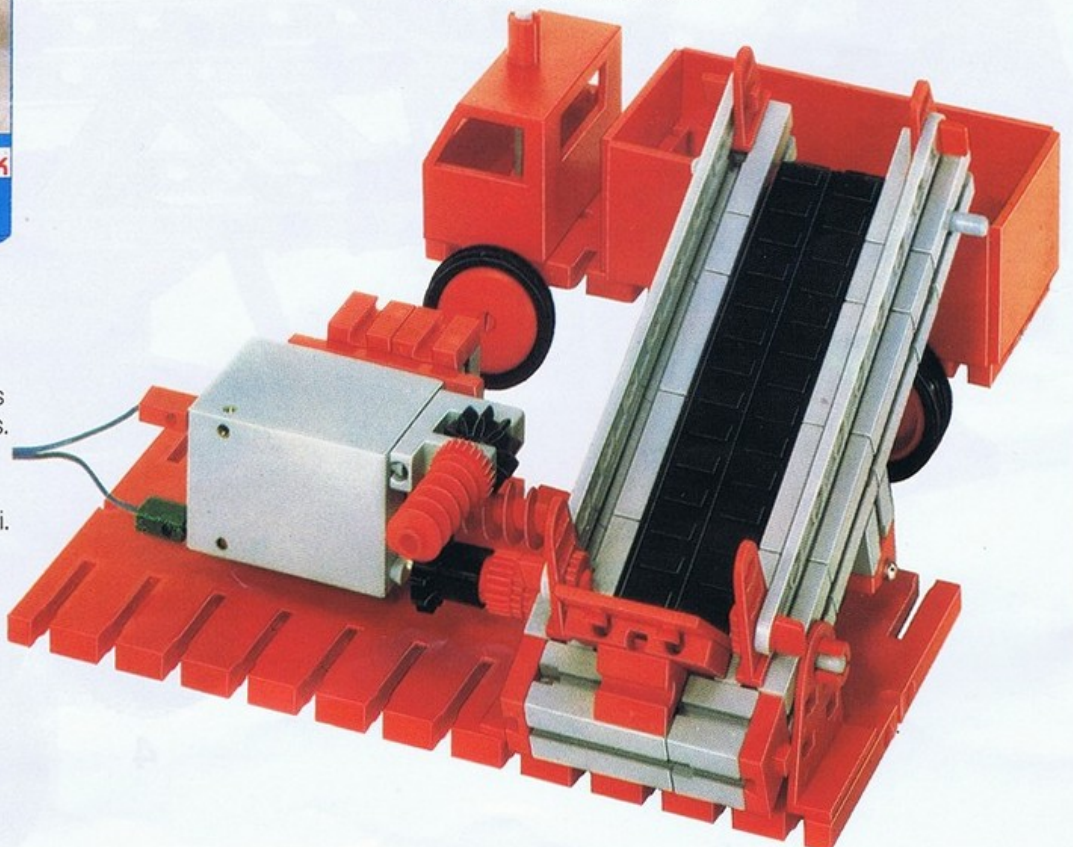



Statik-Elemente für große Kräne, Türme, Karusselle. Voraussetzung Start 100. Ab 6 Jahre.

Static parts for large cranes, towers, roundabouts. Prerequisite: "Start 100". From 6 years.

Éléments de superstructures pour des grandes grues, tours, manèges. «Start 100» indispensable. A partir de 6 ans.

Statika elementen voor grote kranen, torens, draaimolens. Benodigd: „Start 100”. Voor 6 jaar en ouder.

Erweiterungskasten „Statik-Elemente”. Ab 6 Jahre.
 Extension kit "Statics Components". From 6 years.
 Caja complementaria «Elementos de superestructuras». A partir de 6 años.
 Caja de aplicación «Elementos de estática». A partir de 6 años.

Elementos estáticos para grandes grúas, torres, carruseles. Caja indispensable «Start 100». A partir de 6 años.

Elementi di statica per grandi gru, torri e giostre. È necessario «Start 100». Da 6 anni in poi.

Statik-delar för stora kranar, torn, broar, karuseller. Förutsättning »Start 100». Från 6 år.

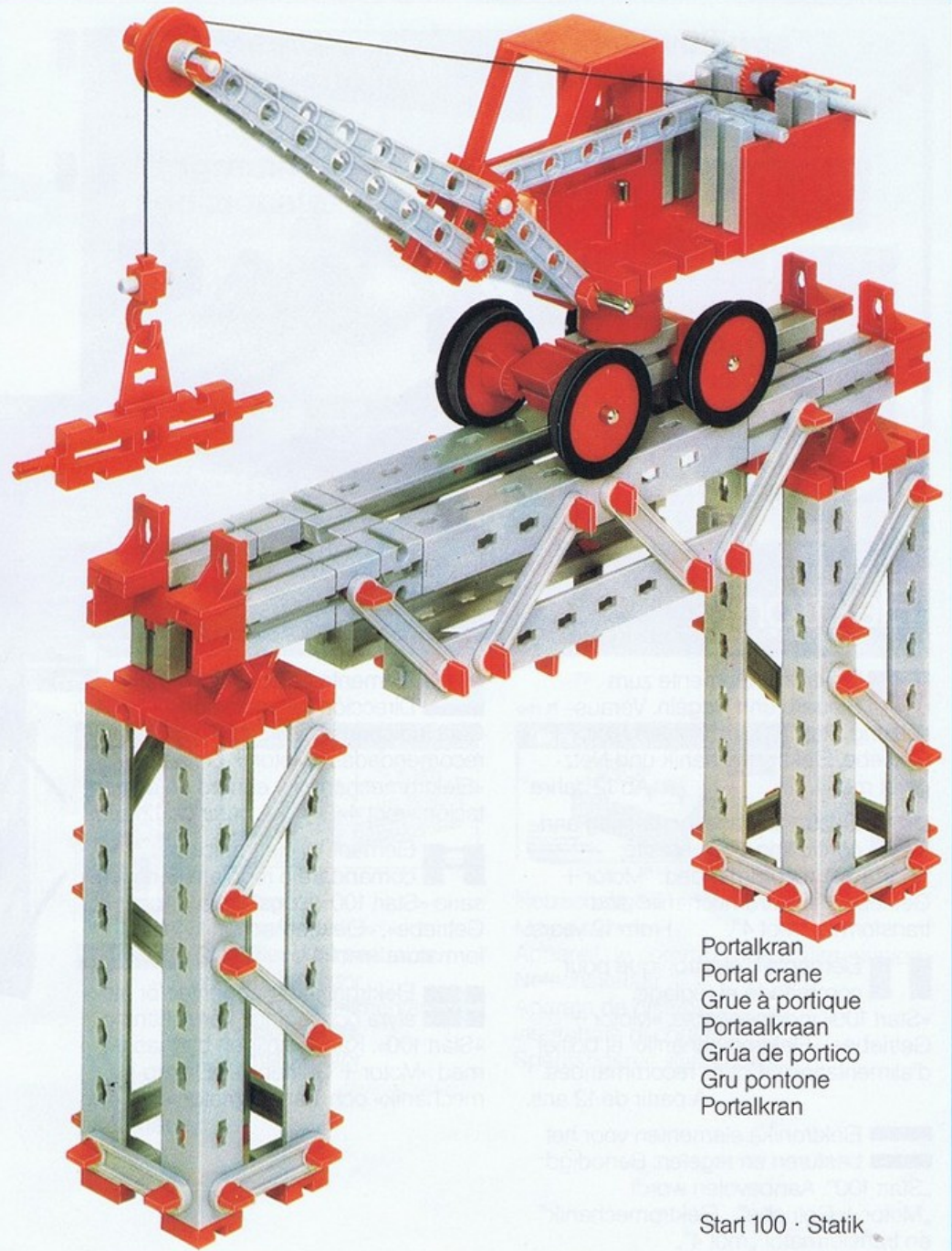

Portalkran
 Portal crane
 Grue à portique
 Portaalkraan
 Grúa de pórtico
 Gru pontone
 Portalkran

Start 100 · Statik



Elektromechanik-Elemente zum Schalten und Steuern. Voraussetzung Start 100, empfohlen Motor + Getriebe und Netzgerät mot 4. Ab 10 Jahre.

Electromechanical parts for switching and steering. Prerequisite: "Start 100", recommended: "Motor + Getriebe" and transformer "mot 4". From 10 years.

Éléments d'électromécanique pour commande et régulation. «Start 100» indispensable, «Motor + Getriebe» et boîtier d'alimentation «mot 4» recommandés. A partir de 10 ans.

Elektromechanika elementen voor het schakelen en besturen. Benodigd: „Start 100”. Aanbevolen wordt „Motor + Getriebe” en transformator „mot 4”. Voor 10 jaar en ouder.

Erweiterungskasten «Elektromechanik-Elemente». Ab 10 Jahre.
 Extension kit "Electro-Mechanical Components". From 10 years.
 Caja complementaria «Elementos d'electromecanica». A partir de 10 años.
 Caja de aplicación «Elementos de electromecanica». A partir de 10 años.

Elementos electromecánicos para conexión y Dirección. Caja indispensable «Start 100», cajas recomendadas «Motor + Getriebe» y equipo de alimentación «mot 4». A partir de 10 años.

Elementi di elettromeccanica per commutare e comandare le costruzioni. È necessario «Start 100», consigliato «Motor + Getriebe» e trasformatore «mot 4». Da 10 anni in poi.

Elektromechanik-komponenter för att styra och reglera. Förutsättning »Start 100». Kan lämpligen byggas ut med »Motor + Getriebe» och Transformator »mot 4». Från 10 år.



Blinkanlage
 Signal equipment
 Installation clignotante
 Knipperlicht
 Emisor de señales luminosas
 Lampeggiatore
 Blinkanläggning

Start 100 · Motor + Getriebe · Elektromechanik



Elektronik-Elemente zum Steuern und Regeln. Voraussetzung Start 100, empfohlen Motor + Getriebe, Elektromechanik und Netzgerät mot 4. Ab 12 Jahre.

Electronic parts for steering and controlling. Prerequisite: "Start 100", recommended: "Motor + Getriebe", "Elektromechanik" and transformer "mot 4". From 12 years.

Eléments d'électronique pour commande et réglage. «Start 100» indispensable, «Motor + Getriebe», «Elektromechanik» et boîtier d'alimentation «mot 4» recommandés. A partir de 12 ans.

Elektronika elementen voor het besturen en regelen. Benodigd: „Start 100“. Aanbevolen wordt „Motor + Getriebe“, „Elektromechanik“ en transformator „mot 4“. Voor 12 jaar en ouder.

Elementos electrónicos par Dirección y Regulación. Caja indispensable «Start 100», cajas recomendadas «Motor + Getriebe», «Elektromechanik» y equipo de alimentación «mot 4». A partir de 12 años.

Elementi di elettronica per comandare e regolare. È necessario «Start 100», consigliato «Motor + Getriebe», «Elektromechanik» e trasformatore «mot 4». Da 12 anni in poi.

Elektronik-komponenter för att styra och reglera. Förutsättning »Start 100». Kan lämpligen byggas ut med »Motor + Getriebe», »Elektromechanik» och Transformator »mot 4». Från 12 år.

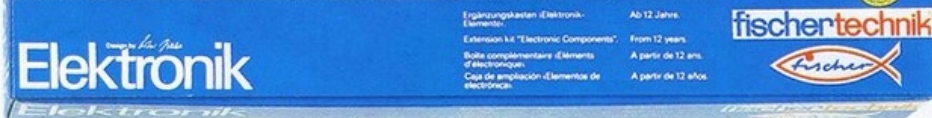

Elektronischer Morsetaster
Electronic morse key
Manipulateur Morse électronique
Elektronische morsetaster
Manipulador Morse electrónico
Tasto morse elettronico
Elektronisk morseapparat

Start 100 · Elektronik



Pneumatik-Elemente der Antriebs- und Steuerungstechnik. Voraussetzung Start 100, empfohlen geeignete Druckluftquelle. Ab 12 Jahre.

Pneumatic parts for power and steering techniques. Prerequisite: "Start 100", recommended: compressed air source. From 12 years.

Eléments de pneumatique pour technique d'entraînement et de commande. «Start 100» indispensable, source d'air comprimé recommandée. A partir de 12 ans.

Pneumatika elementen van aandrijvings- en besturingstechniek. Benodigd: „Start 100“. Aanbevolen wordt beschikbaarheid van zamengeperste lucht. Voor 12 jaar en ouder.

Elementos neumáticos de técnico accionamiento y dirección. Caja indispensable «Start 100», recomendado un equipo de aire comprimido. A partir de 12 años.

Elementi di pneumatica per dare movimento alle costruzioni. È necessario «Start 100» e fonte di aria compressa (compressore). Da 12 anni in poi.

Pneumatik-delar för drivnings- och styrningsteknik. Förutsättning »Start 100». Rekommenderas tryckluft. Från 12 år.



NEU: Pneumatik + enthält zusätzlich fischertechnik Kompressor-Bausatz.
NEW: Pneumatik + contains additional fischertechnik compressor kit.

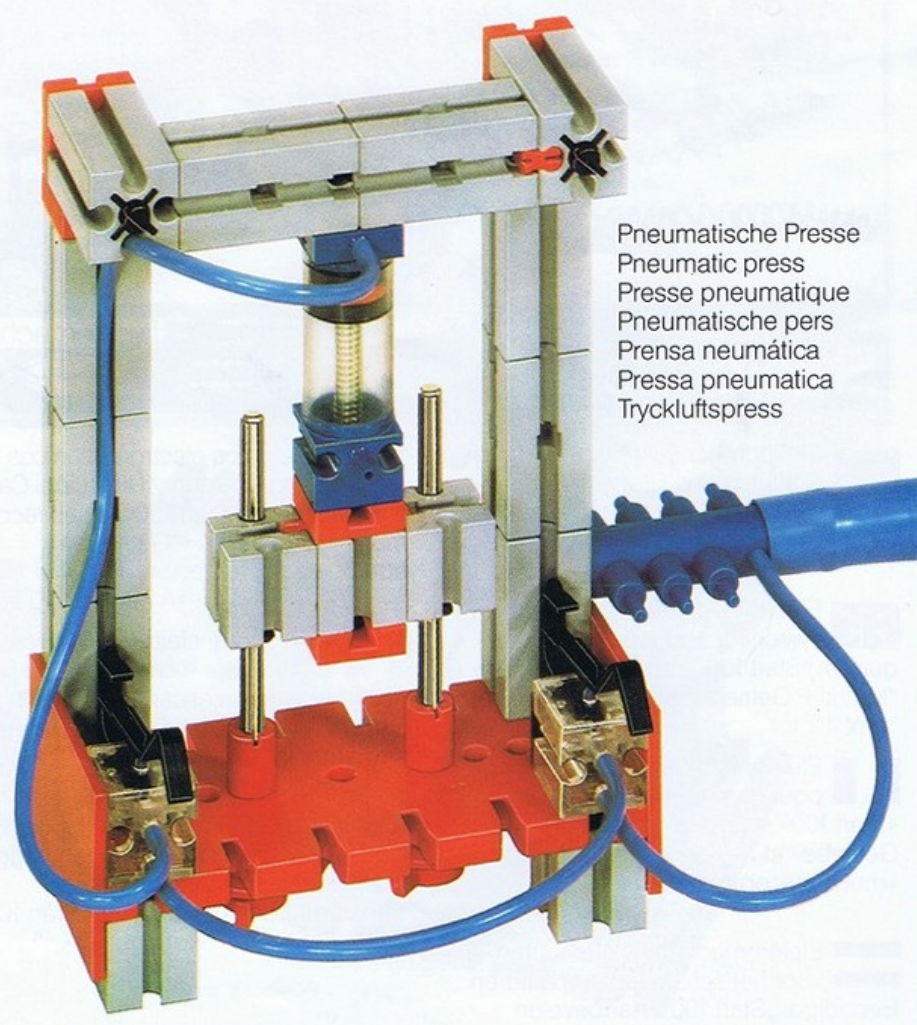

Pneumatische Presse
Pneumatic press
Presse pneumatique
Pneumatische pers
Prensa neumática
Tryckluftspres

Start 100 · Pneumatik

Service-Sets.
Die sinnvolle Ergänzung zum fischertechnik Programm.

Das Service-Set Programm:
30 280 Graue Bausteine
30 282 Rote Bausteine
30 283 Grundplatten und Führerhaus
30 284 Kettenteile
30 285 Räder und Federung
30 286 Batteriehalter
30 287 Flachträger, Bogen u. Streben
30 288 Lampen und Kabel
30 185 Motor
30 186 Mini-Motor + Getriebe
30 187 Mini-Motor

Service-Sets. Un complemento práctico y lógico del programa fischertechnik.

El programa Service-Sets:
30 280 Piezas grises de construcción
30 282 Piezas rojas de construcción
30 283 Placas base y cabina
30 284 Piezas de cadena
30 285 Ruedas y suspensión
30 286 Portabaterías
30 287 Portantes planos, arcos y vigas
30 288 Lámparas y cables
30 185 Motor
30 186 Mini motor + engranaje
30 187 Mini motor

Service-Sets.
En sinnrik komplettering till fischertechnik-programmet.

Service-Sets programmet:
30 280 Gråa byggstenar
30 282 Röda byggstenar
30 283 Bodenplattor och förarhytt
30 284 Kättingar
30 285 Hjul och fjädring
30 286 Batterihållare
30 287 Flatpelare, bågar och strävor
30 288 Lampor och kablar
30 185 Motor
30 186 Mini motor och växellåda
30 187 Mini motor

Service-Sets.
The obvious addition to the fischertechnik range.

The service-set range:
30 280 Grey building blocks
30 282 Red building blocks
30 283 Base plates and cab
30 284 Chain elements
30 285 Wheels and suspension
30 286 Battery container
30 287 Flat support, bow and struts
30 288 Lamps and cabling
30 185 Motor
30 186 Mini-Motor + Gears
30 187 Mini-Motor

Service-Sets. Il complemento ingegnoso del programma fischertechnik.

Il programma Service-Sets:
30 280 Elementi grigi per le costruzioni
30 282 Elementi rossi per le costruzioni
30 283 Basamenti (e cabina)
30 284 Parti di catene
30 285 Ruote e sospensioni
30 286 Portabatteria
30 287 Supporto piatto, archi e sostegni
30 288 Lampade e cavi
30 185 Motore
30 186 Mini motore e cambio di velocità
30 187 Mini motore

Service-Sets. Le complément raisonnable au programme fischertechnik.

Le programme des Service-Sets:
30 280 Eléments de construction gris
30 282 Eléments de construction rouges
30 283 Plaques de base et cabine
30 284 Eléments de chaînes
30 285 Roues et suspension
30 286 Support pour piles
30 287 Support plat, arcs et entretoises
30 288 Lampes et câbles
30 185 Moteur
30 186 Mini-Moteur + Engrenages
30 187 Mini-Moteur

Service-sets. De praktische aanvulling van het fischertechnik-programma.

De Service-set programma:
30 280 grijze bouwstenen
30 282 rode bouwstenen
30 283 basisplaten en drijvershokje
30 284 onderdelen van kettingen
30 285 wielen en vering
30 286 batterijhouder
30 287 platte draagbalken, bostukken en steunbalken
30 288 lampen en kabels
30 185 motor
30 186 mini-motor + aandrijving
30 187 mini-motor



fischertechnik Modellbaukästen.

Technik. Ein Kinderspiel. Die faszinierende Bau- und Spielwelt.

Cajas de construcción para modelos fischertechnik.

La Técnica. Un juego de niños. El mundo fascinante de la construcción y del juego.

fischertechnik Model Construction Kits.

Technology. It's child's play. The fascinating world of building and playing.

Cassette di costruzione dei modelli fischertechnik.

Tecnica. Un gioco da bambini. Il mondo affascinante delle costruzioni e dei giochi.

Modèles à assembler fischertechnik.

La technique. Un jeu d'enfant. Le monde merveilleux et fascinant de jeu et de la construction.

fischertechnik modellbyggglådor.

Teknik. Barnlek. En fascinerande värld i byggande och lek.

fischertechnik modelbouwdozen.

Techniek. Een kinderspeelsetje. De fascinerende bouw- en speelwereld.



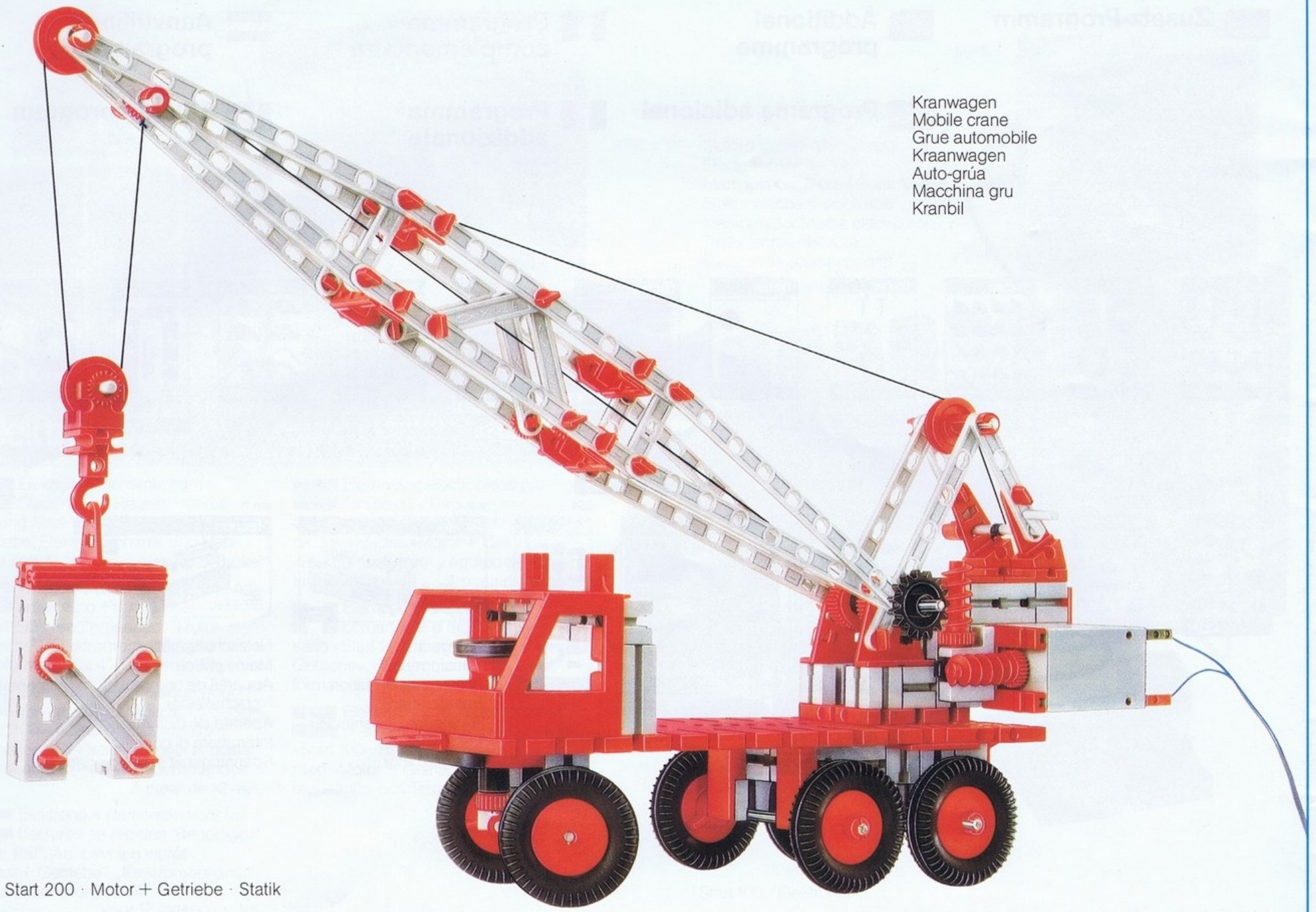





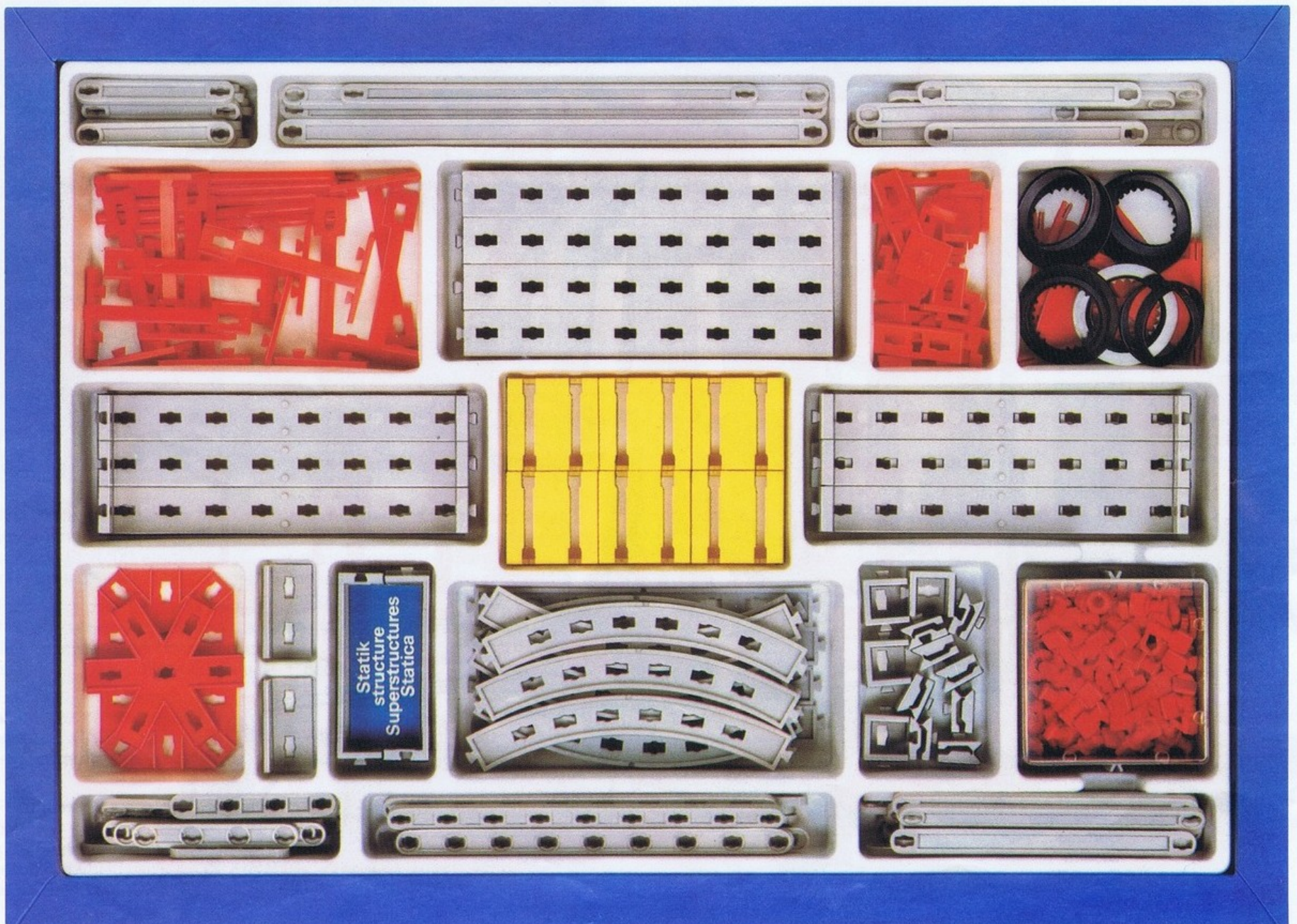













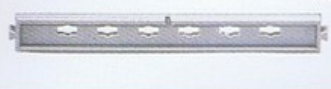





















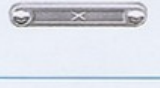

Kranwagen
 Mobile crane
 Grue automobile
 Kraanwagen
 Auto-grúa
 Macchina gru
 Kranbil

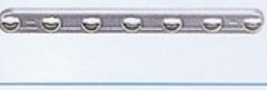
Start 200 · Motor + Getriebe · Statik

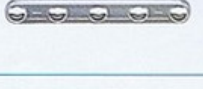

Statik
 structure
 Superstructures
 Statica

Stückliste · Part List · Nomenclature · Onderdelenlijst · Lista de piezas · Lista dei pezzi · Detalj översikt

	8 x Winkelträger 120 · Angle girder 120 · Cornière de 120 · hoekdraagsteun 120 · Porta-angular 120 · Trave angolare 120 · Vinkelbalk 120 Art.-Nr. 4 36303 1		2 x Doppelknotenplatte · Double gusset plate · Gousset · Dubbele hoekverbinding · Placa de unión doble · Piastra nodale doppia · Dubbel sammanbindningsplatta Art.-Nr. 4 31664 1
	4 x Winkelträger 60 · Angle girder 60 · Cornière de 60 · hoekdraagsteun 60 · Porta-angular 60 · Trave angolare 60 · Vinkelbalk 60 Art.-Nr. 4 36302 1		4 x Lasche 15 · Connecting strip 15 · Éclisse de 15 · Rechtverbinding 15 · Eclisa 15 · Coprigiunto 15 · Skarvplatta 15 Art.-Nr. 4 31667 1
	4 x Winkelträger 15 mit 2 Zapfen · Angle girder 15 with 2 lugs · Cornière de 15 à 2 tenons · hoekdraagsteun 15 met 2 nokken · Porta-angular 15 con 2 pivotes · Trave angolare 15 con 2 perni · Vinkelbalk 15 med 2 tappar Art.-Nr. 4 36304 1		8 x Winkellasche · Flexible angle strip · Éclisse coudée · Hoekverbinding · Eclisa acodada · Coprigiunto angolato · Vinkelskarv Art.-Nr. 4 31670 1
	12 x Flachträger 120 · Flat girder 120 · Étrier de 120 · Vlakke draagsteun 120 · Estribu 120 · Trave piatta 120 · Balk 120 Art.-Nr. 4 36305 1		2 x Sternlasche · Star gusset · Gousset en étoile · Sterverbinding · Eclisa en estrella · Connettore a stella · Stjärnskarvsplatta Art.-Nr. 4 31673 1
	4 x Flachstück 120 · Flat strut 120 · Plat de 120 · Vlakke steun 120 · Pieza plana 120 · Pezzo piatto 120 · Bjälke 120 Art.-Nr. 4 36307 1		6 x Adapterlasche · Adaptor connector · Gousset adaptateur · Adapterlus · Eclisa de adaptador · Elemento raccordo adattatore · Skarvplatta adapter Art.-Nr. 4 31674 1
	12 x Bogenstück 60° · Curved strut 60° · Plat cintré de 60° · Boogstuk 60° · Pieza angular 60° · Pezzo curvo 60° · Bågbjälke 60° Art.-Nr. 4 36308 1		24 x S-Riegel 6 · Double rivet 6 · Rivet de 6 · Grendel 6 · Roblón 6 · Rivetto 6 · S-Regel 6 Art.-Nr. 4 36324 1
	2 x Winkelverbinder · Angle connector · Cornière de reprise · Hoekverbinding · Juntas angulares · Connettore a angolo · Vinkelförbindning Art.-Nr. 4 31576 1		80 x S-Riegel 4 · Single rivet 4 · Rivet de 4 · Grendel 4 · Roblon 4 · Rivetto 4 · S-Regel 4 Art.-Nr. 4 36323 1
	14 x Strebe 90 · Strut 90 · Entretoise de 90 · Spant 90 · Montante 90 · Barra 90 · Stråva 90 Art.-Nr. 4 36313 1		2 x Verschlussriegel · Locking pin · Rivet de securité · Afsluitgrendel · Pasador de bloqueo · Chiavistello di chiusura · Regel Art.-Nr. 4 37232 1
	6 x Strebe 60 · Strut 60 · Entretoise de 60 · Spant 60 · Montante 60 · Barra 60 · Stråva 60 Art.-Nr. 4 36311 1		8 x Riegelscheibe · Locking washer · Disque d'arrêt · Grendelschijf · Arandela de retención · Disco di blocco · Regelskiva Art.-Nr. 4 36334 1
	4 x Strebe 30 · Strut 30 · Entretoise de 30 · Spant 30 · Montante 30 · Barra 30 · Stråva 30 Art.-Nr. 4 36309 1		1 x S-Griff · Rivet holder · Tourne-rivet · S-greep · Herra mienta para roblón · Chiavetta · Låsultsgrepp Art.-Nr. 4 35800 1
	4 x Strebe 169,6 · Strut 169,6 · Entretoise de 169,6 · Spant 169,6 · Montante 169,6 · Barra 169,6 · Stråva 169,6 Art.-Nr. 4 36320 1		1 x Kassetten-Unterteil · Cassette, bottom · Coffret, partie inférieure · Cassette, onderstuk · Caja, parte inferior · Cassette, parte inferiore · Kassetunderdel Art.-Nr. 4 35359 1
	2 x Strebe 127,2 · Strut 127,2 · Entretoise de 127,2 · Spant 127,2 · Montante 127,2 · Barra 127,2 · Stråva 127,2 Art.-Nr. 4 36319 1		1 x Kassetten-Deckel · Cassette, top · Coffret, partie supérieure · Cassette deksel · Tapa de caja · Coperchio cassetta · Kassetöverdel Art.-Nr. 4 35360 1
	2 x Strebe 106 · Strut 106 · Entretoise de 106 · Spant 106 · Montante 106 · Barra 106 · Stråva 106 Art.-Nr. 4 36318 1		8 x Scharnier · Hinge · Charnière · Scharnier · Charnela · Cerniera · Gångjärn Art.-Nr. 4 36329 1
	4 x Strebe 84,4 · Strut 84,4 · Entretoise de 84,4 · Spant 84,4 · Montante 84,4 · Barra 84,4 · Stråva 84,4 Art.-Nr. 4 36317 1		4 x Spurkranz · Wheel flange · Boudin · Spoorkranz · Corona · Bordino · Hjulkrans Art.-Nr. 4 36331 1
	4 x Strebe 63,6 · Strut 63,6 · Entretoise de 63,6 · Spant 63,6 · Montante 63,6 · Barra 63,6 · Stråva 63,6 Art.-Nr. 4 36316 1		4 x Gummiring für Spurkranz · Rubber ring for wheel flange · Elastique pour boudin · Rubberring voor spoorkranz · Anillo de goma para corona · Elastico per bordino · Gummiring för hjulkrans Art.-Nr. 4 36332 7
	20 x Strebe 42,4 · Strut 42,4 · Entretoise de 42,4 · Spant 42,4 · Montante 42,4 · Barra 42,4 · Stråva 42,4 Art.-Nr. 4 36315 1		6 x Stein 30/30/15, gelb · Block 30/30/15, yellow · Pierre 30/30/15, jaune · Steen 30/30/15, geel · Piedra 30/30/15, amarilla · Elemento 30/30/15, giallo · Byggsten 30/30/15, gul Art.-Nr. 4 38289 1
	12 x Strebe 120 · Strut 120 · Entretoise de 120 · Spant 120 · Montante 120 · Barra 120 · Stråva 120 Art.-Nr. 4 38532 1		12 x Gondelhalter · Nacelle support · Support de gondole · Gondelsteun · Porta-góndola · Portagondola · Gondelhållare Art.-Nr. 4 31713 1
	2 x Strebe 90 · Strut 90 · Entretoise de 90 · Spant 90 · Montante 90 · Barra 90 · Stråva 90 Art.-Nr. 4 38533 1		6 x Aufhängebügel · Suspending bracket · Etrier de suspension · Ophangbeugel · Estribu de suspensión · Staffa di sospensione · Upphängningsbygel Art.-Nr. 4 31720 1
	2 x Strebe 75 · Strut 75 · Entretoise de 75 · Spant 75 · Montante 75 · Barra 75 · Stråva 75 Art.-Nr. 4 38534 1		2 x Mitnehmer · Axle stay · Mécanisme d'entraînement · Meenemer · Arrastrador · Trascinatore · Medbringare Art.-Nr. 4 31712 1
	2 x Strebe 60 · Strut 60 · Entretoise de 60 · Spant 60 · Montante 60 · Barra 60 · Stråva 60 Art.-Nr. 4 38535 1		6 x V-Achse 4 x 80 · V-axle 4 x 30 · Axe-V 4 x 80 · V-as 4 x 80 · Eje en V 4 x 80 · Asse a V 4 x 80 · V-axel 4 x 80 Art.-Nr. 4 35405 1
	4 x Strebe 45 · Strut 45 · Entretoise de 45 · Spant 45 · Montante 45 · Barra 45 · Stråva 45 Art.-Nr. 4 38536 1		8 x Klemmbuchse 5 · Spring clip 5 · Bague de serrage 5 · Klembus 5 · Anillo de apriete 5 · Bussola di serraggio 5 · Klåmbussning 5 Art.-Nr. 3 37679 1
	4 x Strebe 30 · Strut 30 · Entretoise de 30 · Spant 30 · Montante 30 · Barra 30 · Stråva 30 Art.-Nr. 4 38537 1		

fischertechnik COMPUTING

Roboter, Automaten und Grafikgeräte
zum Selberbauen.

Robots, automats and graphic units
to build yourself.

Robots, automates et appareils
graphiques à monter soi-même.



fischertechnik

Ferngesteuerte fischertechnik
in Kombination mit Robbe Fernsteueranlagen.

Remotely controlled fischertechnik
in combination with Robbe remote controls.

fischertechnik télécommandée
en combinaison avec les radiocommandes Robbe.

