

Explore the  
world of  
fischertechnik.

**fischertechnik** 

# How to build with fischertechnik

Our modular fischertechnik system comes with a variety of building blocks, connectors, gears, wheels, and other components. These building blocks are designed to fit together using a unique interlocking system, allowing you to build sturdy and complex structures. Let's get started! Simply slide the blocks into each other, and you can build your first basic models.

## Meet our hero

Our basic building block

Versatility

Allows the construction of additional building blocks on all six sides.

Stability

The pin and groove joint creates a strong connection between the building blocks.

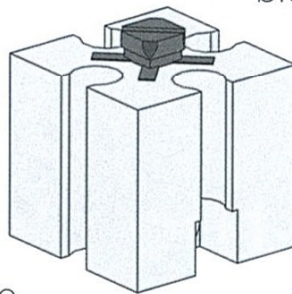
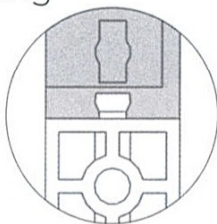

Creativity

There are endless creative opportunities for your creations.

...slide and play!

# Animal companion

Duffy the Dog



1

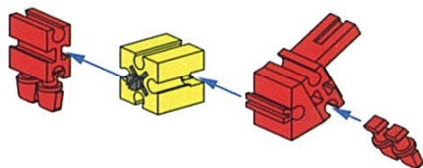

2

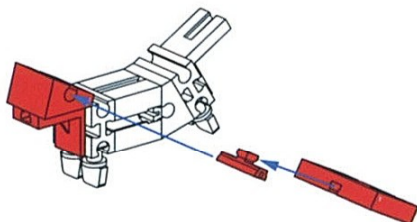

3

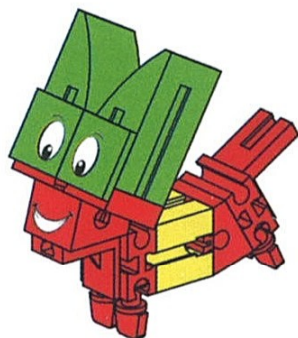
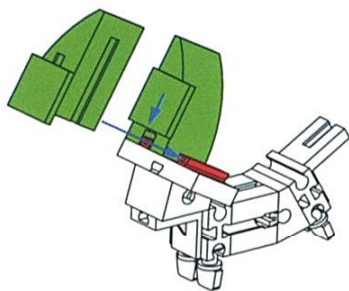

# Practical tool

## C-Clamp

1

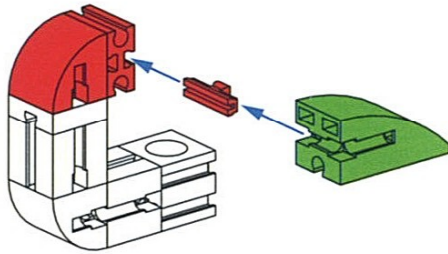

2

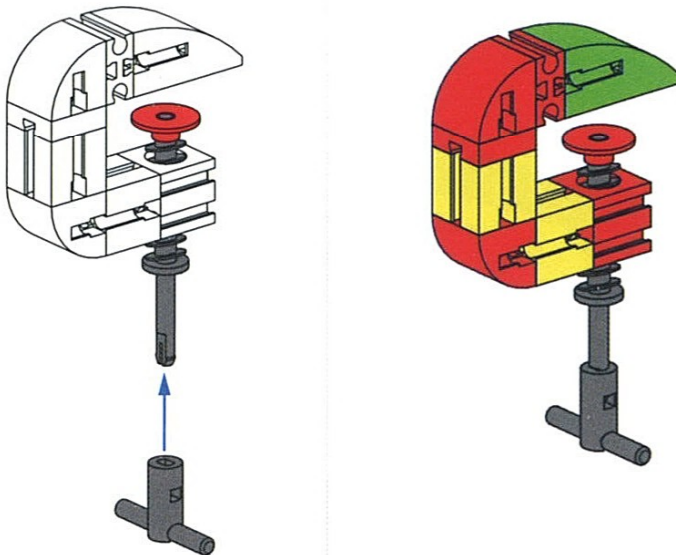

# Inspired technology

## Static bridge

1

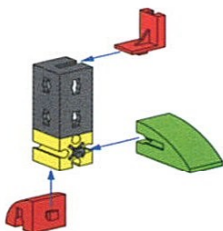

2

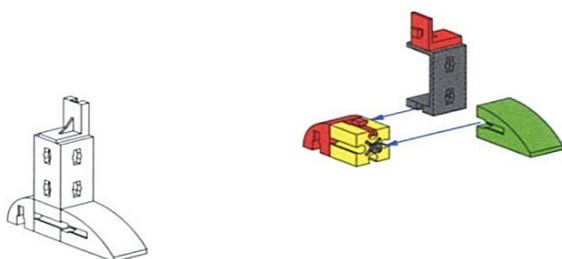

3

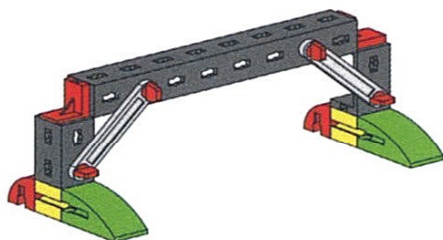
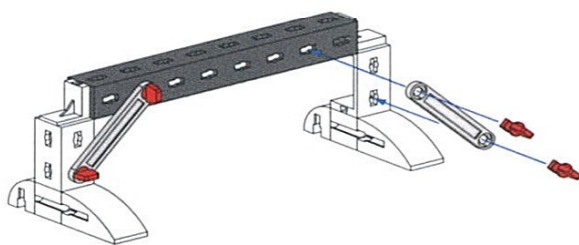



Explore more

**fischertechnik** 

fischertechnik GmbH  
Klaus-Fischer-Str. 1  
D-72178 Waldachtal

[www.fischertechnik.de](http://www.fischertechnik.de)

Art.-Nr. 571101 / 204162 - 02/25 - Printed in Germany

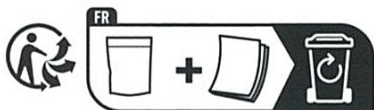

Raccolta  
differenziata

